



Product Description: T260XW02 TFT-LCD PANEL with RoHS Guarantee

AUO Model Name: T260XW02 VL

Customer Part No/Project Name:

Customer Signature	Date	AUO	2007/12/7
		Approved By: PM Director Frank Hsu.	
		Reviewed By: RD Director Wang, Hong-Jin 12/12 2007 Reviewed By: Project Leader: Polo Shen 12/7	
		Prepared By: Anson Wang,	



Document Version: 0.3

Date: 2007/12/17

Product Specifications

26.0" WXGA Color TFT-LCD Module

Model Name: T260XW02 VL

() Preliminary Specifications

(* Final Specifications



Contents

No	ITEM
	COVER
	CONTENTS
	RECORD OF REVISIONS
1	GENERAL DESCRIPTION
2	ABSOLUTION MAXIMUM RATINGS
3	ELECTRICAL SPECIFICATIONS
3-1	ELECTRICAL CHARACTERISTICS
3-2	INTERFACE CONNECTIONS
3-3	SIGNAL TIMING SPECIFICATIONS
3-4	SIGNAL TIMING WAVEFORMS
3-5	COLOR INPUT DATA REFERENCE
3-6	POWER SEQUENCE for LCD
3-7	POWER SEQUENCE for INVERTER
4	OPTICAL SPECIFICATIONS
5	MECHANICAL CHARACTERISTICS
5-1	Front view
5-2	Rear view
6	RELIABILITY
7	INTERNATIONAL STANDARDS
7-1	SAFETY
7-2	EMC
7-3	Green
8	PACKING
9	PRECAUTIONS



Record of Revision

Version	Date	No	Old Description	New Description	Remark
0.3	2007/ 12/17				Final Spec



1. General Description

This specification applies to the 26.0 inch Color TFT-LCD Module T260XW02. This LCD module has a TFT active matrix type liquid crystal panel 1366x768 pixels, and diagonal size of 26.0 inch. This module supports 1366x768 XGA-WIDE mode(Non-interlace).

Each pixel is divided into Red, Green and Blue sub-pixels or dots which are arranged in vertical stripes. Gray scale or the brightness of the sub-pixel color is determined with a 8-bit gray scale signal for each dot.

The T260XW02 has been designed to apply the 8-bit 1 channel LVDS interface method. It is intended to support displays where high brightness, wide viewing angle, high color saturation, and high color depth are very important.

* General Information

Items	Specification	Unit	Note
Active Screen Size	26.0	inches	
Display Area	575.769 (H) x 323.712(V)	mm	
Pixel Pitch	0.4215	mm	
Outline Dimension	626.0 (H) x 373.0 (V) x 47.2(D)	mm	With inverter
Driver Element	a-Si TFT active matrix		
Display Colors	16.7M	Colors	
Number of Pixels	1366 x 768	Pixel	
Pixel Arrangement	RGB vertical stripe		
Display Mode	Normally Black		
BL Structure	6 U-Lamps		
Surface Treatment	AG-SR6		
Green	RoHS compliance		



2. Absolute Maximum Ratings

The following are maximum values which, if exceeded, may cause faulty operation or damage to the unit.

Item	Symbol	Min	Max	Unit	Condition s
Logic/LCD Drive Voltage	V _{CC}	-0.3	13.2	[Volt]	Note 1
LVDS Option Control Voltage	V _{LVDSOPT}	-0.3	3.6	[Volt]	Note 1
BLU Input Voltage	V _{DDB}	-0.3	27.0	[Volt]	Note 1
External Analog Dimming Control Voltage	V _{DIM}	-0.3	6.0	[Volt]	Note 1
On/Off Control Voltage	V _{BLON}	-0.3	6.0	[Volt]	Note 1
Internal PWM Dimming Control Voltage	V _{DIM}	-0.3	6.0	[Volt]	Note 1
Operating Temperature	T _{OP}	0	+50	[°C]	Note 2
Operating Humidity	H _{OP}	10	90	[%RH]	Note 2
Storage Temperature	T _{ST}	-20	+60	[°C]	Note 2
Storage Humidity	H _{ST}	10	90	[%RH]	Note 2

Note 1: Duration = 1 sec

Note 2: Maximum Wet-Bulb should be 39°C and No condensation.

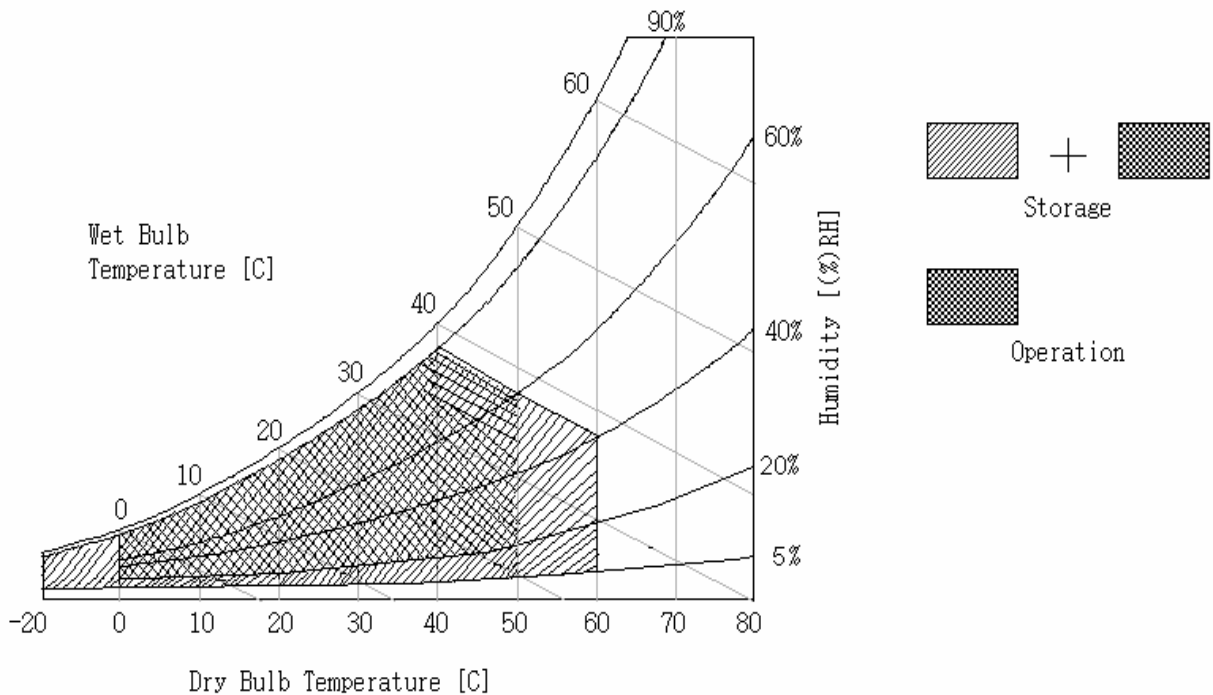



3. Electrical Specification

The T260XW02 requires two power inputs. One is employed to power the LCD electronics and to drive the TFT array and liquid crystal. The second input power for the BLU is to power inverter.

3-1 Electrical Characteristics

Parameter	Symbol	Values			Unit	Notes
		Min.	Typ.	Max.		
LCD:						
Power Supply Input Voltage	V _{CC}	10.8	12	13.2	V	
Power Supply Input Current	I _{CC}	-	0.42		A	1
Power Consumption	P _C	-	4.8		Watt	1
Inrush Current	I _{RUSH}	-	-	3.0	A	2
LVDS Interface:						
Differential Input High Threshold Voltage	V _{TH}			+100	mV	
Differential Input Low Threshold Voltage	V _T L	-100			mV	
Common Input Voltage	V _{CIM}	1.10	1.25	1.40	V	
CMOS Interface:						
Input High Threshold Voltage	V _{IH} (High)	2.4		3.3	V _{dc}	
Input Low Threshold Voltage	V _{IL} (Low)	0		0.7	V _{dc}	
Backlight Power Consumption		-	-	79.4	Watt	3
Life Time		50,000	60,000		Hours	4

Note :

1. V_{CC}=12.0V, F_v=60Hz, F_{clk}= 85.0 MHz , 25°C . , Test Pattern : White Pattern
2. V_{CC} rising time = 470 μs , V_{CC}=12.0V
3. V_{DDB}=24V, V_{DIM}=3.3V, P_{DIM}=100%, test in the whole period from V_{DDB} power on to power off.
4. The performance of the Lamp in LCM, for example: lifetime or brightness, is extremely influenced by the characteristics of the DC-AC Inverter. So all the parameters of an inverter should be carefully designed so as not to produce too much leakage current from high-voltage output of the inverter. When you design or order the inverter, please make sure unwanted lighting caused by the mismatch of the lamp and the inverter (no lighting, flicker, etc) never occurs. When you confirm it, the LCD Assembly should be operated in the same condition as installed in your instrument.
5. Do not attach a conducting tape to lamp connecting wire. If the lamp wire attach to conducting tape, TFT-LCD Module have a low luminance and the inverter has abnormal action because leakage current occurs between lamp wire and conducting tape.
6. The relative humidity must not exceed 80% non-condensing at temperatures of 40°C or less. At temperatures greater than 40°C, the wet bulb temperature must not exceed 39°C. When operate at low temperatures, the brightness of CCFL will drop and the lifetime of CCFL will be reduced.



3-2 Interface Connections

- LCD connector (CN1): JAE FI-X30SSL-HF

Note:

1. All GND (ground) pins should be connected together and should also be connected to the LCD's metal frame. All Vcc (power input) pins should be connected together.

Pin No	Symbol	Description	Default
1	VCC	+12V, DC, Regulated	
2	VCC	+12V, DC, Regulated	
3	VCC	+12V, DC, Regulated	
4	VCC	+12V, DC, Regulated	
5	GND	Ground and Signal Return	
6	GND	Ground and Signal Return	
7	GND	Ground and Signal Return	
8	GND	Ground and Signal Return	
9	LVDS Option	Low/Open for Normal (NS), High for JEIDA	
10	Reserved	Open or High	
11	GND	Ground and Signal Return for LVDS	
12	RIN0-	LVDS Channel 0 negative	
13	RIN0+	LVDS Channel 0 positive	
14	GND	Ground and Signal Return for LVDS	
15	RIN1-	LVDS Channel 1 negative	
16	RIN1+	LVDS Channel 1 positive	
17	GND	Ground and Signal Return for LVDS	
18	RIN2-	LVDS Channel 2 negative	
19	RIN2+	LVDS Channel 2 positive	
20	GND	Ground and Signal Return for LVDS	
21	RCLK-	LVDS Clock negative	
22	RCLK+	LVDS Clock positive	
23	GND	Ground and Signal Return for LVDS	
24	RIN3-	LVDS Channel 3 negative	
25	RIN3+	LVDS Channel 3 positive	
26	GND	Ground and Signal Return for LVDS	
27	Reserved	Open or High	
28	Reserved	Open or High	
29	GND	Ground and Signal Return	
30	GND	Ground and Signal Return	



LVDS Option = H (3.3V) → JETDA Format

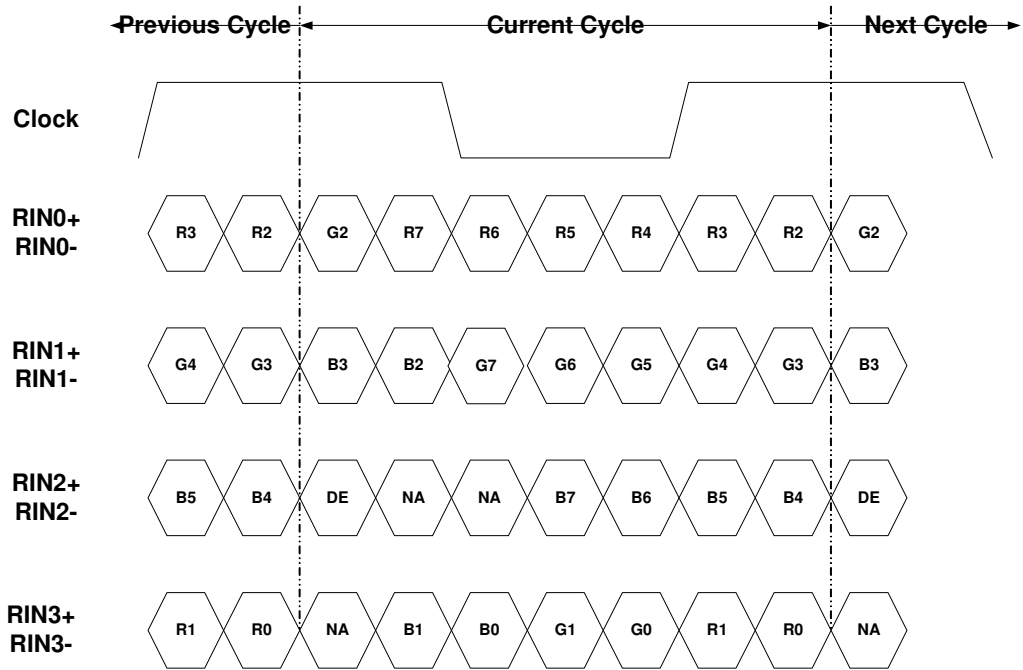

LVDS Option = L (GND) or N.C. → NS Format

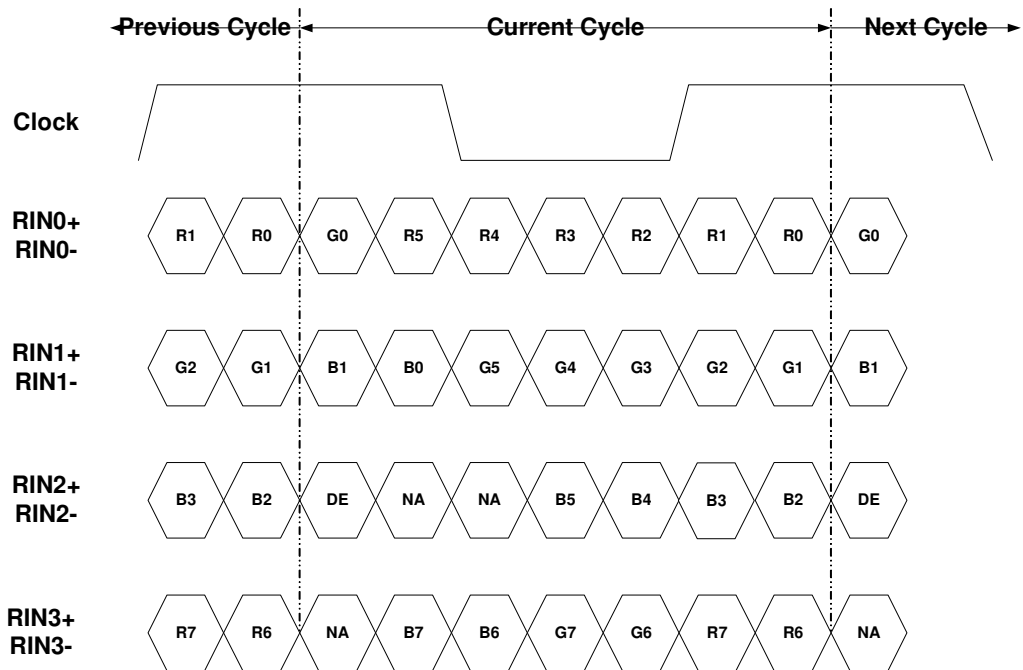



BACKLIGHT CONNECTOR PIN CONFIGURATION

1. Electrical specification

(Ta=25±5°C)

No	ITEM	SYMBOL	CONDITION	MIN	TYP	MAX	UNIT	Note	
1	Input Voltage	V _{DDB}	---	21.6	24.0	26.4	V		
2	Input Current (Turn on Condition)	I _{DDB}	V _{DDB} =24V V _{DIM} =3.3V		(3.7)		A	1	
3	Input Power (Turn on Condition)	P _{DDB}	V _{DDB} =24V V _{DIM} =3.3V	---	(88.8)		W	1	
4	Input Current (Stable Condition)	I _{DDB}	V _{DDB} =24V V _{DIM} =3.3V	3.01	3.16	3.31	A	1	
5	Input Power (Stable Condition)	P _{DDB}	V _{DDB} =24V V _{DIM} =3.3V	72.2	75.8	79.4	W	1	
6	Input inrush current, 20ms	I _{RUSH}	V _{DD} =24V V _{DIM} =3.3V	---	---	6	A		
7	Output Frequency	F _{BL}	V _{DD} =24V	56	58	60	kHz		
8	ON/OFF Control Voltage	V _{B_{BLON}}	ON	V _{DD} =24V	2.0	3.3	5.0	V	
			OFF	V _{DD} =24V	0.0	---	0.8	V	or Open
9	ON/OFF Control Current	I _{B_{BLON}}	V _{DD} =24V	-1	---	1.5	mA		
10	Dimming Control Voltage	V _{DIM}	MAX	V _{DD} =24V	---	3.3	---	V	or Open
			MIN	V _{DD} =24V	---	0.0	---	V	
11	Dimming Control Current	I _{DIM}	V _{DD} =24V	---	---	1.5	mA		

Note1: Condition: V_{DDB}=24V (Ta=25±5°C, Turn on for 45minutes), PWM=100%



2. Input specification

Pin No	Symbol	Description	Default
Pin No	Symbol	Description	24V
1	VDDDB(main power)	DC input 24V VDC	24V
2	VDDDB(main power)	DC input 24V VDC	24V
3	VDDDB(main power)	DC input 24V VDC	24V
4	VDDDB(main power)	DC input 24V VDC	24V
5	VDDDB(main power)	DC input 24V VDC	GND
6	GND	Ground	GND
7	GND	Ground	GND
8	GND	Ground	GND
9	GND	Ground	GND
10	GND	Ground	-
11	Panel DET	Panel status detect Inverter OK: Low/GND (0-0.8V) Inverter NG: open collector	-
12	VBLON	BL on-off : high/open(3.3 ~ 5V) for BL on, low(GND) for BL off	-
13	VDIM (LCD Bright)	VDIM: Internal PWM Dimming control signal input (DC 0~3.3V) (3.3V : Maximum brightness, 0V min brightness) < NC ; when External PWM >	-
14	PDIM (LCD Bright)	PDIM: External PWM Dimming control signal input (AC 0~3.3V, Duty: 20%~100%) < NC ; when internal PWM >	-

CN1: S14B-PHA-SM-TB (JST)

CN2: CP042EP1MFA-LF (Civilux)



3-3 Signal Timing Specifications

This is the signal timing required at the input of the User connector. All of the interface signal timing should be satisfied with the following specifications for its proper operation.

* Timing Table

DE only Mode
Vertical Frequency

Signal	Item	Symbol	Min.	Typ.	Max.	Unit
Vertical Section	Period	Tv	784	806	1015	Th
	Active	Tdisp(v)	768			Th
	Blanking	Tblk (v)	16	38	247	Th
Horizontal Section	Period	Th	1414	1648	1900	Tclk
	Active	Tdisp(h)	1366			Tclk
	Blanking	Tblk (h)	48	282	534	Tclk
LVDS Clock	Frequency	Fclk (1/Tclk)	60	80	85	MHz
Vertical Frequency	Frequency	Fv	47	60	63	Hz
Horizontal Frequency	Frequency	Fh	43	48	53	kHz

*1) Display position is specific by the rise of DE signal only.

Horizontal display position is specified by the falling edge of 1st Clock right after the rise of DE, is displayed on the left edge of the screen.

Vertical display position is specified by the rise of DE after a “Low” level period equivalent to eight times of horizontal period. The 1st data corresponding to one horizontal line after the rise of DE is displayed at the top line of screen.

*2) If a period of DE “High” is less than 1366 Clock or less than 768 lines, the rest of the screen displays black.

*3) The display position does not fit to the screen if a period of DE “High” and the effective data period do not synchronize with each other.



3-4 Signal Timing Waveforms

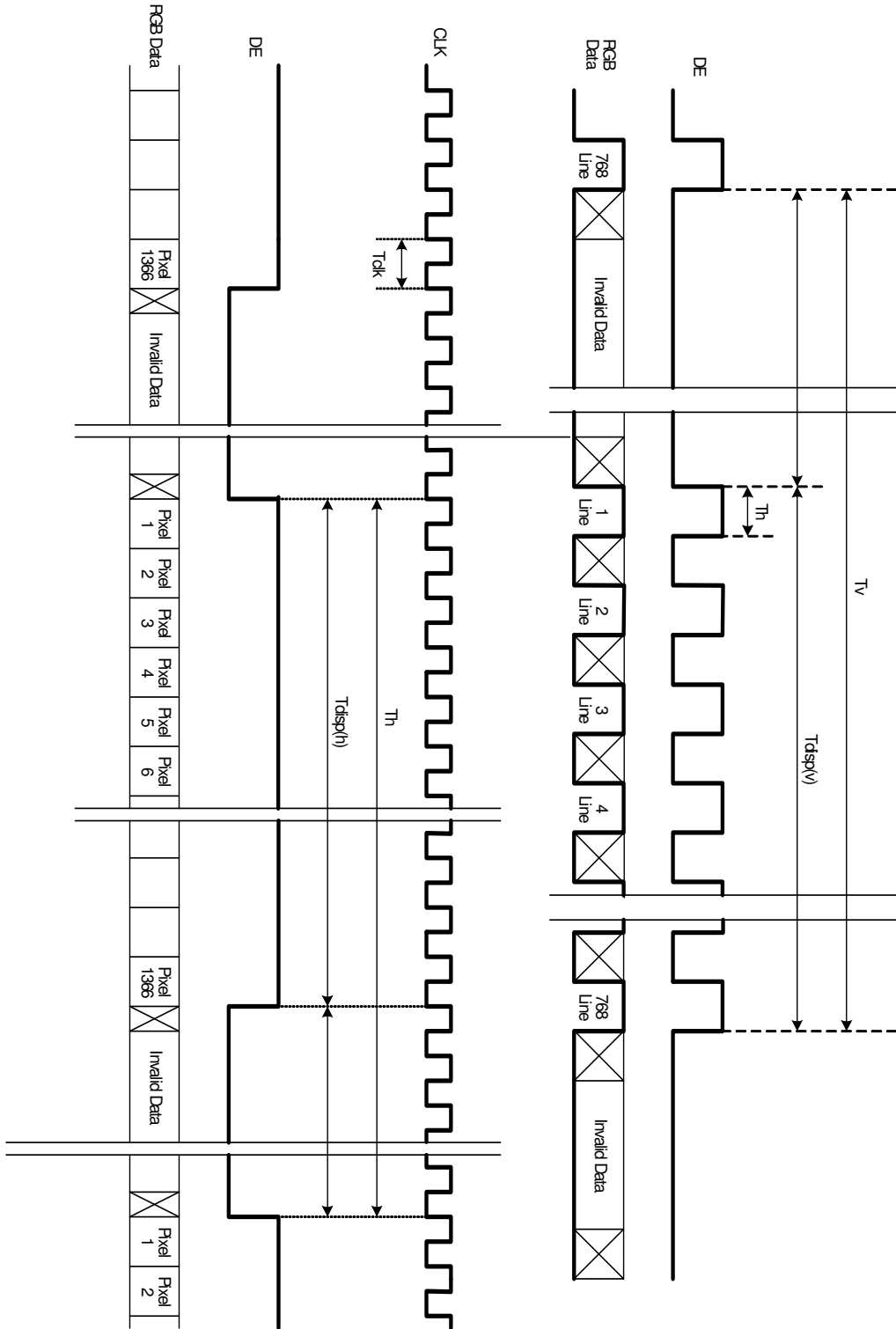



3-5 Color Input Data Reference

The brightness of each primary color (red, green and blue) is based on the 8 bit gray scale data input for the color; the higher the binary input, the brighter the color. The table below provides a reference for color versus data input.

COLOR DATA REFERENCE

Color		Input Color Data																							
		RED								GREEN								BLUE							
		MSB				LSB				MSB				LSB				MSB				LSB			
		R7	R6	R5	R4	R3	R2	R1	R0	G7	G6	G5	G4	G3	G2	G1	G0	B7	B6	B5	B4	B3	B2	B1	B0
Basic Color	Black	0	0	0	0	0	0	0	0	0	0	0	0	0	0	0	0	0	0	0	0	0	0	0	0
	Red(255)	1	1	1	1	1	1	1	1	0	0	0	0	0	0	0	0	0	0	0	0	0	0	0	0
	Green(255)	0	0	0	0	0	0	0	0	1	1	1	1	1	1	1	1	0	0	0	0	0	0	0	0
	Blue(255)	0	0	0	0	0	0	0	0	0	0	0	0	0	0	0	0	1	1	1	1	1	1	1	1
	Cyan	0	0	0	0	0	0	0	0	1	1	1	1	1	1	1	1	1	1	1	1	1	1	1	1
	Magenta	1	1	1	1	1	1	1	1	0	0	0	0	0	0	0	0	1	1	1	1	1	1	1	1
	Yellow	1	1	1	1	1	1	1	1	1	1	1	1	1	1	1	1	0	0	0	0	0	0	0	0
	White	1	1	1	1	1	1	1	1	1	1	1	1	1	1	1	1	1	1	1	1	1	1	1	1
RED	RED(000)	0	0	0	0	0	0	0	0	0	0	0	0	0	0	0	0	0	0	0	0	0	0	0	0
	RED(001)	0	0	0	0	0	0	0	1	0	0	0	0	0	0	0	0	0	0	0	0	0	0	0	0

	RED(254)	1	1	1	1	1	1	1	0	0	0	0	0	0	0	0	0	0	0	0	0	0	0	0	0
	RED(255)	1	1	1	1	1	1	1	1	0	0	0	0	0	0	0	0	0	0	0	0	0	0	0	0
GREEN	GREEN(000)	0	0	0	0	0	0	0	0	0	0	0	0	0	0	0	0	0	0	0	0	0	0	0	0
	GREEN(001)	0	0	0	0	0	0	0	0	0	0	0	0	0	0	0	1	0	0	0	0	0	0	0	0

	GREEN(254)	0	0	0	0	0	0	0	0	1	1	1	1	1	1	1	0	0	0	0	0	0	0	0	0
	GREEN(255)	0	0	0	0	0	0	0	0	1	1	1	1	1	1	1	1	0	0	0	0	0	0	0	0
BLUE	BLUE(000)	0	0	0	0	0	0	0	0	0	0	0	0	0	0	0	0	0	0	0	0	0	0	0	0
	BLUE(001)	0	0	0	0	0	0	0	0	0	0	0	0	0	0	0	0	0	0	0	0	0	0	0	1

	BLUE(254)	0	0	0	0	0	0	0	0	0	0	0	0	0	0	0	0	1	1	1	1	1	1	1	0
	BLUE(255)	0	0	0	0	0	0	0	0	0	0	0	0	0	0	0	0	1	1	1	1	1	1	1	1



3-6 Power Sequence for LCD

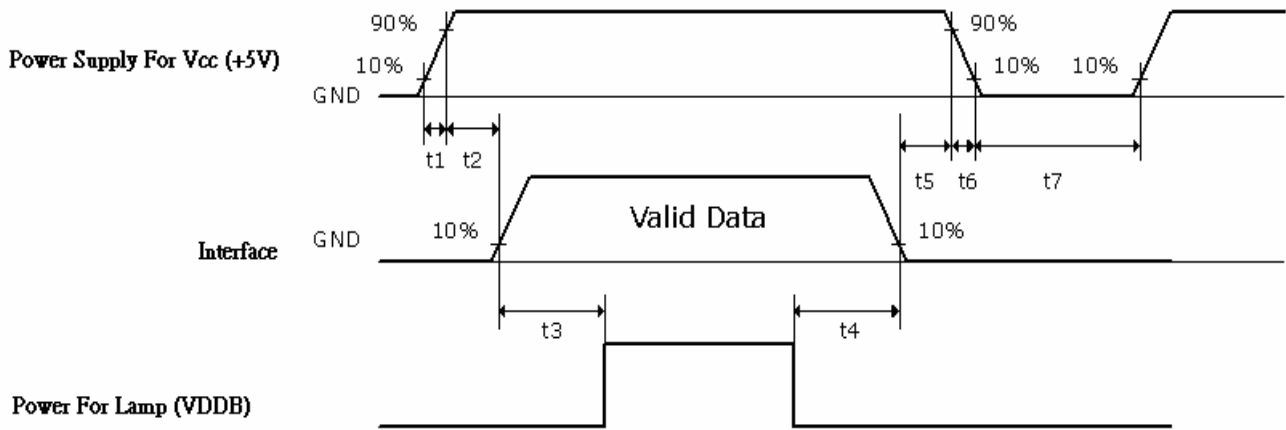

Parameter	Values			Units
	Min.	Typ.	Max.	
t1	0.4	-	30	ms
t2	0.1	-	50	ms
t3	200	-	-	ms
t4	10	-	-	ms
t5	0.1	-	50	ms
t6	-	-	300	ms
t7	300	-	-	ms

- (1) Apply the lamp voltage within the LCD operation range. When the back-light turns on before the LCD operation or the LCD turns off before the back-light turns off, the display may momentarily become abnormal screen.



3-7 Power Sequence for Inverter

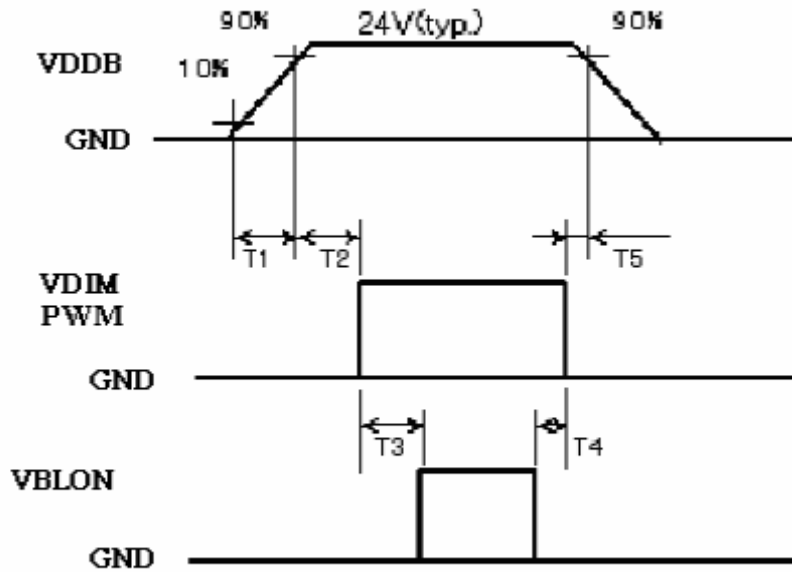

Parameter	Values			Units
	Min.	Typ.	Max.	
T1	20	-	-	Ms
T2	10	-	-	Ms
T3	0	-	-	Ms
T4	50	-	-	Ms
T5	0	-	-	Ms

4. Optical Specification

Optical characteristics are determined after the unit has been 'ON' and stable for approximately 45 minutes in a dark environment at 25°C. The values specified are at an approximate distance 50cm from the LCD surface at a viewing angle of Φ and θ equal to 0°. Signal generator used for measurement is "Chroma 2913" and signal setting follows the typical value shown in page 13 with vertical frequency range A ($f_v=60\text{Hz}$). Meanwhile, dimmer is 3.3(V) for its maximum setting.

Fig.1 1 presents additional information concerning the measurement equipment and method.

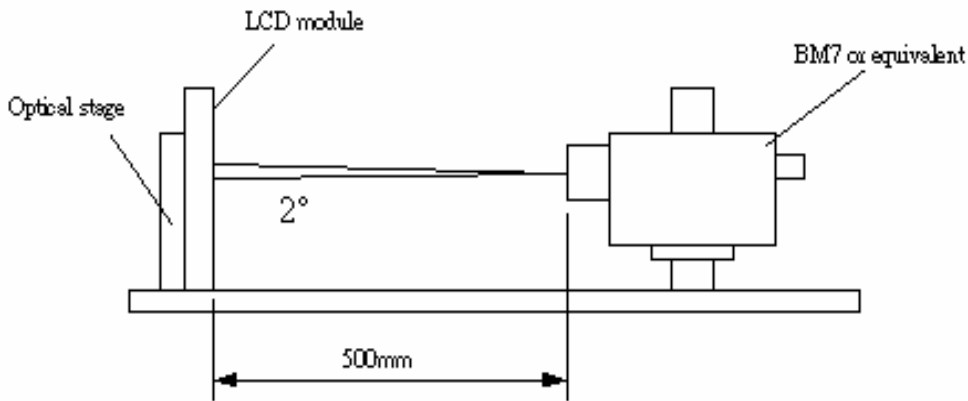

Parameter	Symbol	Values			Units	Notes
		Min.	Typ.	Max.		
Contrast Ratio	CR	2000	2500			1
Surface Luminance, white	LWH	400	500		cd/m ²	2
Luminance Variation	$\delta_{\text{WHITE}} \leq 9\%$			1.3		3
Response Time (G to G)	T _y		6.5		ms	4
Color Gamut	NTSC		72		%	
Color Coordinates						
	RED	R _x	Typ.-0.03	0.635	Typ.+0.03	
		R _y		0.334		
	GREEN	G _x		0.284		
		G _y		0.592		
	BLUE	B _x		0.147		
		B _y		0.052		
	WHITE	W _x		0.277		
		W _y		0.286		
Viewing Angle						
	x axis, right($\phi=0^\circ$)	θ_r		88		Degree
	x axis, left($\phi=180^\circ$)	θ_l		88		
	y axis, up($\phi=90^\circ$)	θ_u		88		
	y axis, down ($\phi=0^\circ$)	θ_d		88		

Note:

1. Contrast Ratio (CR) is defined mathematically as:

$$\text{Contrast Ratio} = \frac{\text{Surface Luminance of } L_{on1}}{\text{Surface Luminance of } L_{off1}}$$

2. Surface luminance is luminance value at point 1 across the LCD surface 50cm from the surface with all pixels displaying white. From more information see FIG 2. When $V_{DDB} = 24V$, $I_{DDB} = 3.5A$. $L_{WH} = L_{on1}$

Where L_{on1} is the luminance with all pixels displaying white at center 1 location.

3. The variation in surface luminance, δ_{WHITE} is defined (center of Screen) as:

$$\delta_{WHITE(9P)} = \frac{\text{Maximum}(L_{on1}, L_{on2}, \dots, L_{on9})}{\text{Minimum}(L_{on1}, L_{on2}, \dots, L_{on9})}$$

4. Response time T_{γ} is the average time required for display transition by switching the input signal for five luminance ratio (0%,25%,50%,75%,100% brightness matrix) and is based on $f_v = 60\text{Hz}$ to optimize.

	0%	25%	50%	75%	100%
0%		t:0%-25%	t:0%-50%	t:0%-75%	t:0%-100%
25%	t:25%-0%		t:25%-50%	t:25%-75%	t:25%-100%
50%	t:50%-0%	t:50%-25%		t:50%-75%	t:50%-100%
75%	t:75%-0%	t:75%-25%	t:75%-50%		t:75%-100%
100%	t:100%-0%	t:100%-25%	t:100%-50%	t:100%-75%	

5. Viewing angle is the angle at which the contrast ratio is greater than 10. The angles are determined for the horizontal or x axis and the vertical or y axis with respect to the z axis which is normal to the LCD surface. For more information see FIG4.

FIG. 2 Luminance

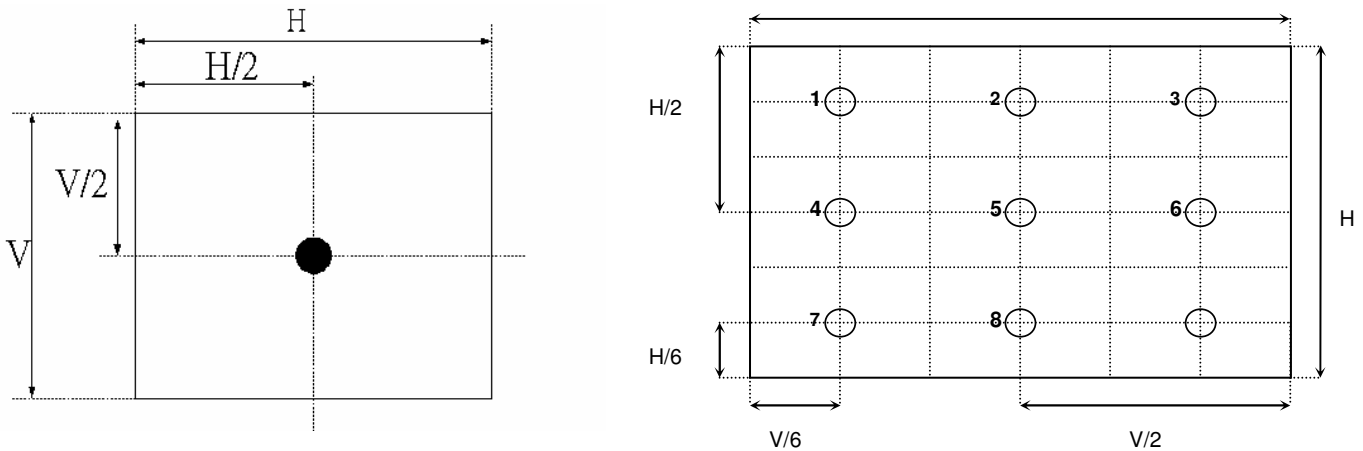

FIG.3 Response Time

The response time is defined as the following figure and shall be measured by switching the input signal for “any level of gray(bright) “ and “any level of gray(dark)”.

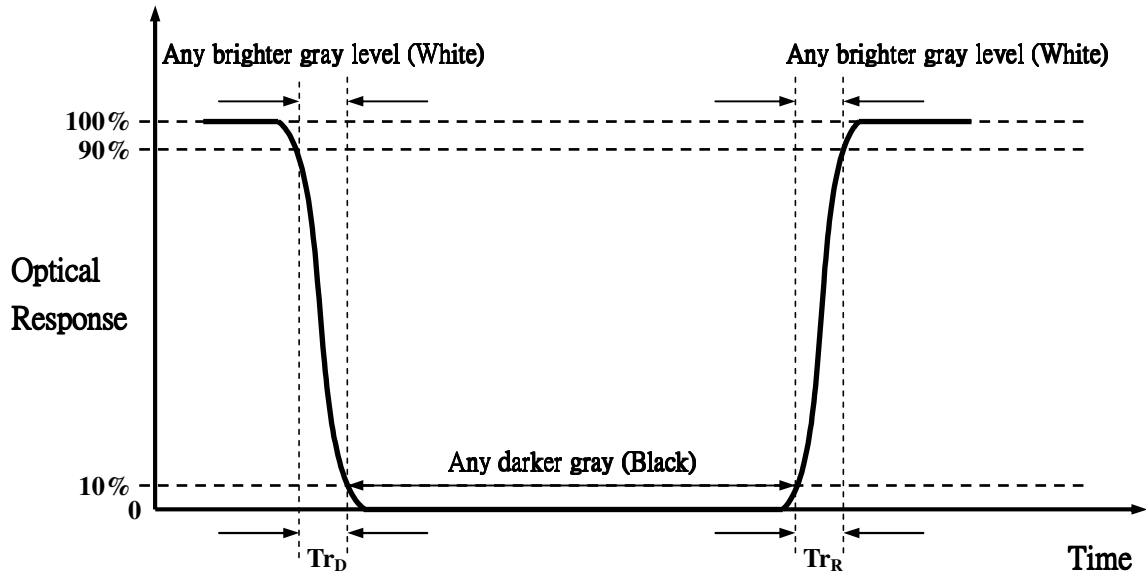
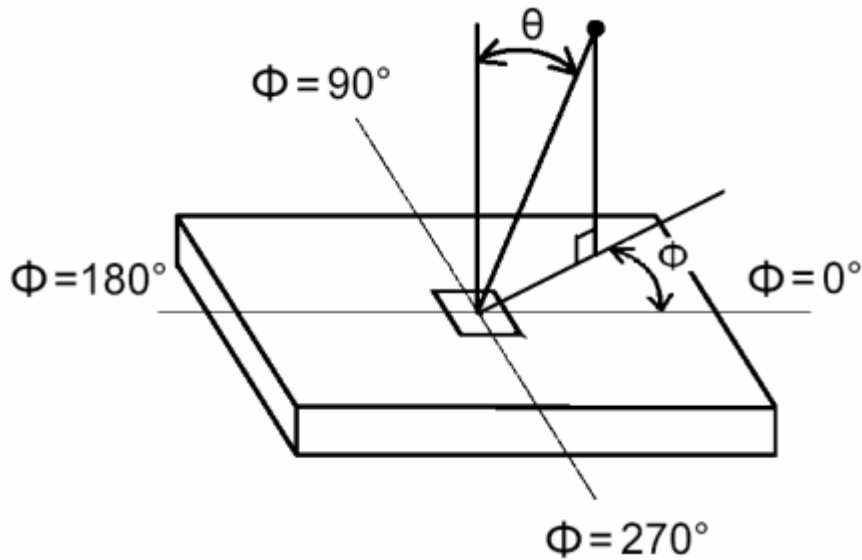

FIG.4 Viewing angle





5. Mechanical Characteristics

The contents provide general mechanical characteristics for the model T260XW02. In addition the figures in the next page are detailed mechanical drawing of the LCD.

Outline Dimension	Horizontal	626.0mm
	Vertical	373.0mm
	Depth	47.2mm(w/i inverter& Shielding) 30.2mm(w/o inverter)
Bezel Area	Horizontal	580.8mm±0.5mm
	Vertical	328.8mm±0.5mm
Active Display Area	Horizontal	575.769mm
	Vertical	323.712mm
Weight	4500g (Typ.)	
Surface Treatment	AG-SR6	



5.1 Front View

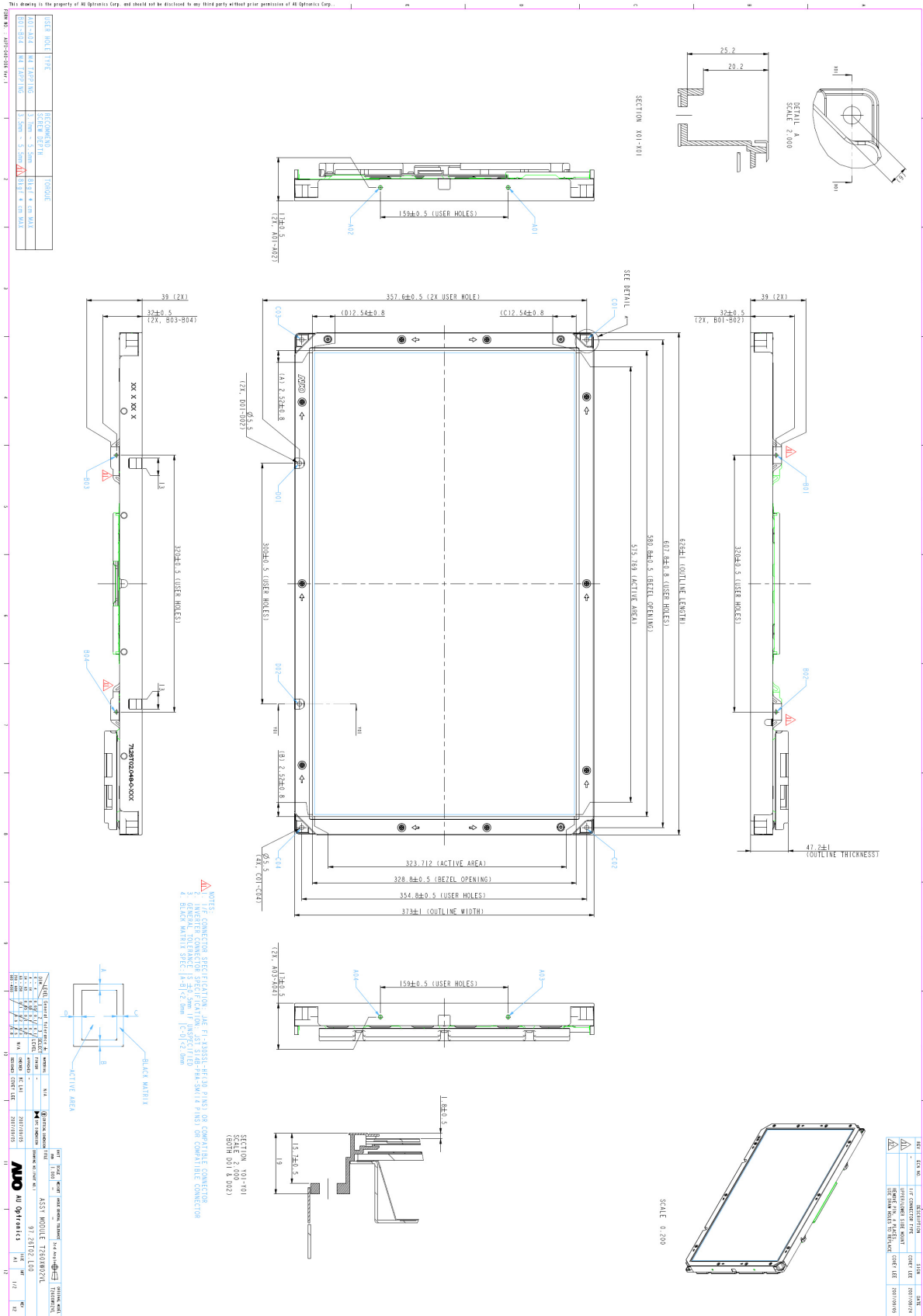



6. Reliability

Environment test condition

	Test Items	Q'ty	Conditions
1	High Temperature Stroage	3	60°C 300 hrs
2	Low Temperature Stroage	3	-20°C, 300 hrs
3	High Temperature Operation	3	50°C, 300 hrs
4	Low Temperature Operation	3	-5°C, 300 hrs
5	Vibration (non-operation)	3	(10 ~ 300Hz/1.5G/11min SR, XYZ 30min/axis) Vibration level : 1.5G RMS, Bandwidth : 10-300Hz Duration: X, Y, Z 30min,
6	Shock (non-operation)	3	Shock level: 50G Waveform: have sine wave, 11ms Direction: ±X,±Y, ±Z One time each direction
7	Vibration (With carton)	3	Random wave (1.5 Grms 10~200Hz) 30mins / Per each X.Y.Z axes
8	Drop (With carton)	3	Height: 46cm 1 corner, 3 edges, 6 surfaces (ASTMD4169-I)



7. International Standard

7-1. Safety



- (1) UL1950 Third Edition, Underwriters Laboratories, Inc. Jan. 28, 1995
Standard for Safety of Information Technology Equipment Including electrical Business Equipment.
- (2) CAN/CSA C22.2 No. 950-95 Third Edition, Canadian Standards Association, Jan. 28, 1995
Standard for Safety of Information Technology Equipment Including Electrical Business Equipment.
- (3) EN60950: 1992+A2: 1993+A2: 1993+C3: 1995+A4: 1997+A11: 1997
IEC 950: 1991+A1: 1992+A2: 1993+C3: 1995+A4:1996
European Committee for Electro technical Standardization (CENELEC)
EUROPEAN STANDARD for Safety of Information Technology Equipment Including Electrical Business Equipment.
- (4) EN60065

7-2. EMC

- a) ANSI C63.4 “Methods of Measurement of Radio-Noise Emissions from Low-Voltage Electrical and Electrical Equipment in the Range of 9kHz to 40GHz. “American National standards Institute(ANSI), 1992.
- b) C.I.S.P.R “Limits and Methods of Measurement of Radio Interface Characteristics of Information Technology Equipment.” International Special committee on Radio Interference.
- c) EN 55022 “Limits and Methods of Measurement of Radio Interface Characteristics of Information Technology Equipment.” European Committee for Electro technical Standardization. (CENELEC), 1998.

7-3. Green

Green Mark Description:

- a) For Pb Free products, AUO will add  for identification.
- b) For RoHS compatible products, AUO will add  for identification.

Note. The Green Mark will be present only when the green documents have been ready by AUO Internal Green Team. (The definition of green design follows the AUO green design checklist.)



8. Packing

Label sample



TW5A01100005-ZMA00*

TW5A011: Production lot (T-Taiwan, 5-year, 1~C-month)

00005: Panel serial number

ZMA: AUO internal code

Manufactured 05/43: 2005 week 43

Carton Label

AU O ptronics	QTY: 5
MODEL NO: T260XW02 VX	
PART NO: 97.26T02.XXX	
CUSTOMER NO:	
CARTON NO:	
Made in Taiwan	*PM100-01A1600001*



Carton Size 722(L) mm*325(W) mm*469(H) mm

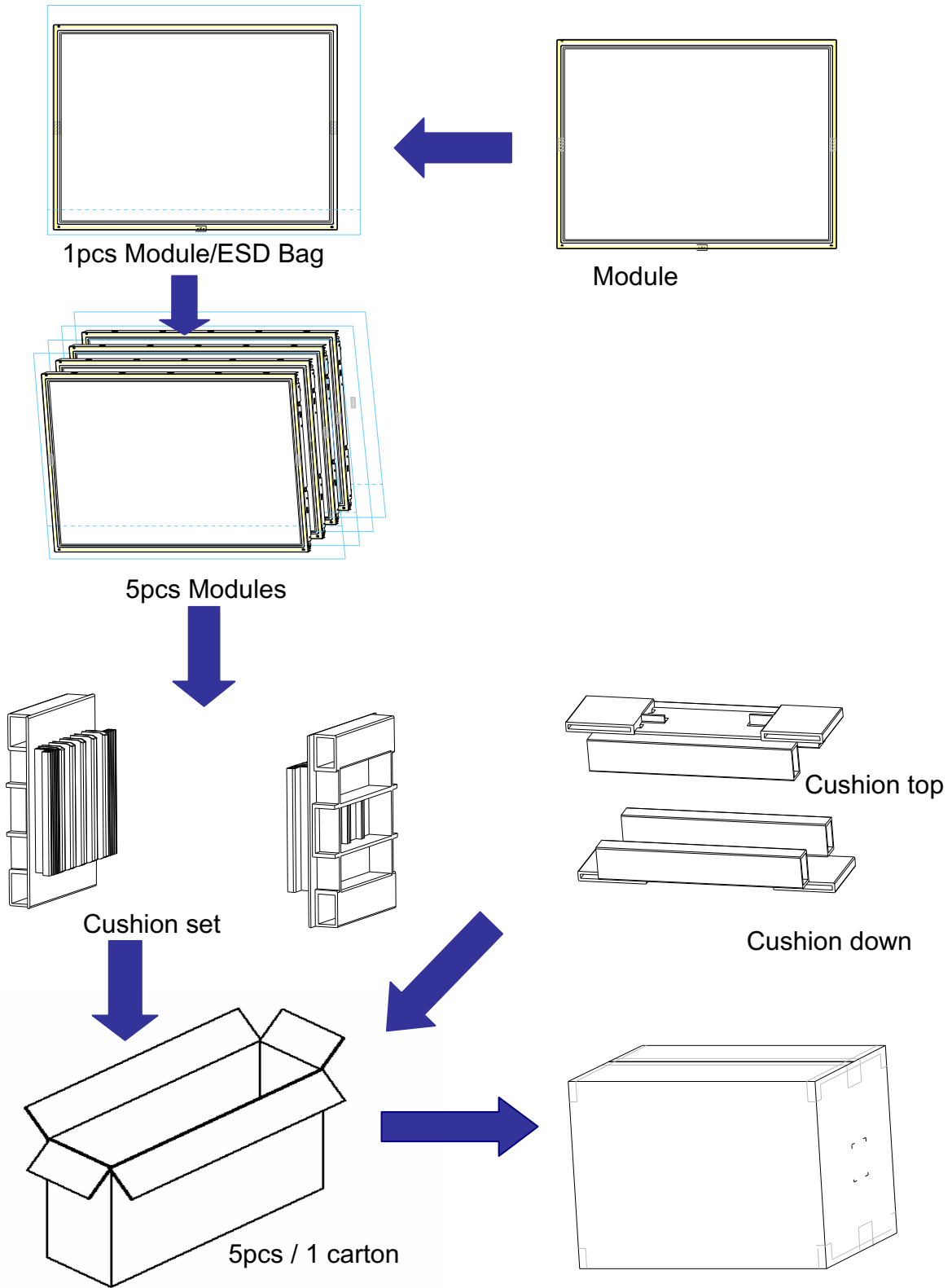



	Item	Specification			Packing Remark
		Qty.	Dimension	Weight (kg)	
1	Packing BOX	5pcs/box	722(L)mm*325(W)mm*469(H)mm	26.4	
2	Pallet	1	980(L)mm*730(W)mm*120(H)mm		
3	Boxes per Pallet	6 boxes/Pallet			
4	Panels per Pallet	30pcs/pallet			
	Pallet after packing	30	980(L)mm*730(W)mm*1058(H)mm	178.4	



9. PRECAUTIONS

Please pay attention to the followings when you use this TFT LCD module.

9-1 MOUNTING PRECAUTIONS

- (1) You must mount a module using holes arranged in four corners or four sides.
- (2) You should consider the mounting structure so that uneven force (ex. Twisted stress) is not applied to module. And the case on which a module is mounted should have sufficient strength so that external force is not transmitted directly to the module.
- (3) Please attach the surface transparent protective plate to the surface in order to protect the polarizer. Transparent protective plate should have sufficient strength in order to resist external force.
- (4) You should adopt radiation structure to satisfy the temperature specification.
- (5) Acetic acid type and chlorine type materials for the cover case are not desirable because the former generates corrosive gas of attacking the polarizer at high temperature and the latter causes circuit break by electro-chemical reaction.
- (6) Do not touch, push or rub the exposed polarizers with glass, tweezers or anything harder than HB pencil lead. And please do not rub with dust clothes with chemical treatment. Do not touch the surface of polarizer for bare hand or greasy cloth. (Some cosmetics are detrimental to the polarizer.)
- (7) When the surface becomes dusty, please wipe gently with absorbent cotton or other soft materials like chamois soaks with petroleum benzene. Normal-hexane is recommended for cleaning the adhesives used to attach front/ rear polarizers. Do not use acetone, toluene and alcohol because they cause chemical damage to the polarizer.
- (8) Wipe off saliva or water drops as soon as possible. Their long time contact with polarizer causes deformations and color fading.
- (9) Do not open the case because inside circuits do not have sufficient strength.

9-2 OPERATING PRECAUTIONS

- (1) The device listed in the product specification sheets was designed and manufactured for TV application
- (2) The spike noise causes the mis-operation of circuits. It should be lower than following voltage: $V=\pm 200\text{mV}$ (Over and under shoot voltage)
- (3) Response time depends on the temperature. (In lower temperature, it becomes longer..)
- (4) Brightness depends on the temperature. (In lower temperature, it becomes lower.) And in lower temperature, response time (required time that brightness is stable after turned on) becomes longer.
- (5) Be careful for condensation at sudden temperature change. Condensation makes damage to polarizer or electrical contacted parts. And after fading condensation, smear or spot will occur.
- (6) When fixed patterns are displayed for a long time, remnant image is likely to occur.
- (7) Module has high frequency circuits. Sufficient suppression to the electromagnetic interference shall be done by system manufacturers. Grounding and shielding methods may



be important to minimize the interface.

9-3 ELECTROSTATIC DISCHARGE CONTROL

Since a module is composed of electronic circuits, it is not strong to electrostatic discharge. Make certain that treatment persons are connected to ground through wrist band etc. And don't touch interface pin directly.

9-4 PRECAUTIONS FOR STRONG LIGHT EXPOSURE

Strong light exposure causes degradation of polarizer and color filter.

9-5 STORAGE

When storing modules as spares for a long time, the following precautions are necessary.

- (1) Store them in a dark place. Do not expose the module to sunlight or fluorescent light. Keep the temperature between 5°C and 35°C at normal humidity.
- (2) The polarizer surface should not come in contact with any other object. It is recommended that they be stored in the container in which they were shipped.

9-6 HANDLING PRECAUTIONS FOR PROTECTION FILM

- (1) The protection film is attached to the bezel with a small masking tape. When the protection film is peeled off, static electricity is generated between the film and polarizer. This should be peeled off slowly and carefully by people who are electrically grounded and with well ion-blown equipment or in such a condition, etc.
- (2) When the module with protection film attached is stored for a long time, sometimes there remains a very small amount of glue still on the Bezel after the protection film is peeled off.
- (3) You can remove the glue easily. When the glue remains on the Bezel or its vestige is recognized, please wipe them off with absorbent cotton waste or other soft material like chamois soaked with normal-hexane.