

PRODUCT INFORMATION

FEATURES

- (1) 8.9" wide display size for notebook PC
- (2) LVDS interface system
- (3) Slim(5.2mmMAX)

TENTATIVE

MECHANICAL SPECIFICATIONS

Item	Specifications
Dimensional Outline (Typ.)	224.0(W) x 129.0(H) x 5.2max(D) mm
Number of Pixels	1024(W) x 600(H) pixels
Active Area	195.07(W) x 113.40(H) mm
Pixel Pitch	0.1905(W) x 0.1890(H)
Weight (approximately)	160 g
Backlight	Single CCFL, Sidelight type

ABSOLUTE MAXIMUM RATINGS

Item	Min.	Max.	Unit	
Supply Voltage	(V _{DD})	-0.3	4.0	V
	(V _{FL})	-	2.0	kV(rms)
FL Driving Frequency (f _{FL})	-	100	kHz	
Input Signal Voltage (V _{IN})	-0.3	V _{DD} +0.3	V	
Operating Temperature	0	50	°C	
Storage Temperature	-20	60	°C	
Storage Humidity	10	90	%(RH)	

ELECTRICAL SPECIFICATION (T_a=25°C) (RECOMMENDED OPERATION CONDITION)

Item	Min.	Typ.	Max.	Unit	Remarks	
Supply Voltage	(V _{DD})	3.0	3.3	3.6	V	
	(V _{FL})	520	570	620	V(rms)	I _{FL} =3.0 mA(rms)
FL Start Voltage (T _a =0°C)	1300	---	---	V(rms)		
Differential Input Voltage	(V _{ID})	100	---	600	mV	
Comon Mode Input Voltage	(V _{CM})	1.0	---	2.4-V _{ID} /2	V	
Current Consumption	*2 (I _{DD})	---	180	250	mA	
	*3 (I _{FL})	2.0	3.0	4.2	mA(rms)	
*2 *3 Power Consumption	---	2.6	---	W	I _{FL} =3.0 mA(rms)	

*1 : Refer to THC63LVDF84A-85 Specification by THine Electronics, Inc.

*2 : 8 color bars pattern

*3 : Excepting the efficiency FL inverter

OPTICAL SPECIFICATION (T_a=25°C)

Item	Min.	Typ.	Max.	Unit	Remarks
Contrast Ratio (CR)	100	---	---	---	
Response Time	(t _{ON})	---	---	50	ms
	(t _{OFF})	---	---	50	ms
Luminance (L)	---	140	---	cd/m ²	I _{FL} =3.0mA(rms)

*The information contained herein is presented only as a guide for the applications of our products. No responsibility is assumed by Toshiba Matsushita Display Technology or other rights of the third parties which may result from its use. No license is granted by implication or otherwise under any patent or patent rights of Toshiba or others.

*The information contained herein may be changed without prior notice. It is therefore advisable to contact Toshiba before proceeding with the design of equipment incorporating this product.

DIMENSIONAL OUTLINE (front figure)

Unit : mm

Standard tolerance : ±0.5

TENTATIVE

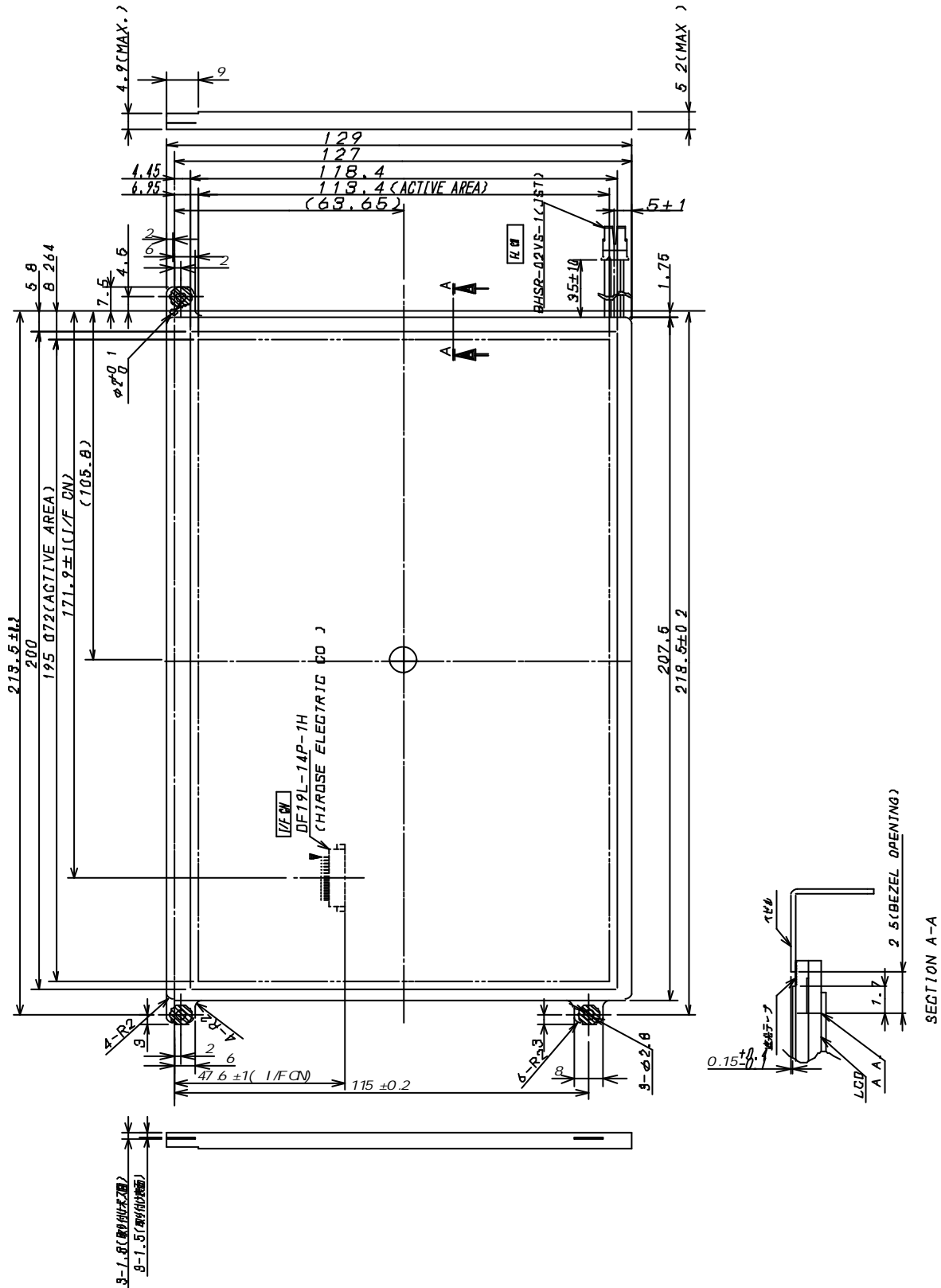

DIMENSIONAL OUTLINE (back figure)

Unit : mm

Standard tolerance : ± 0.5

TENTATIVE

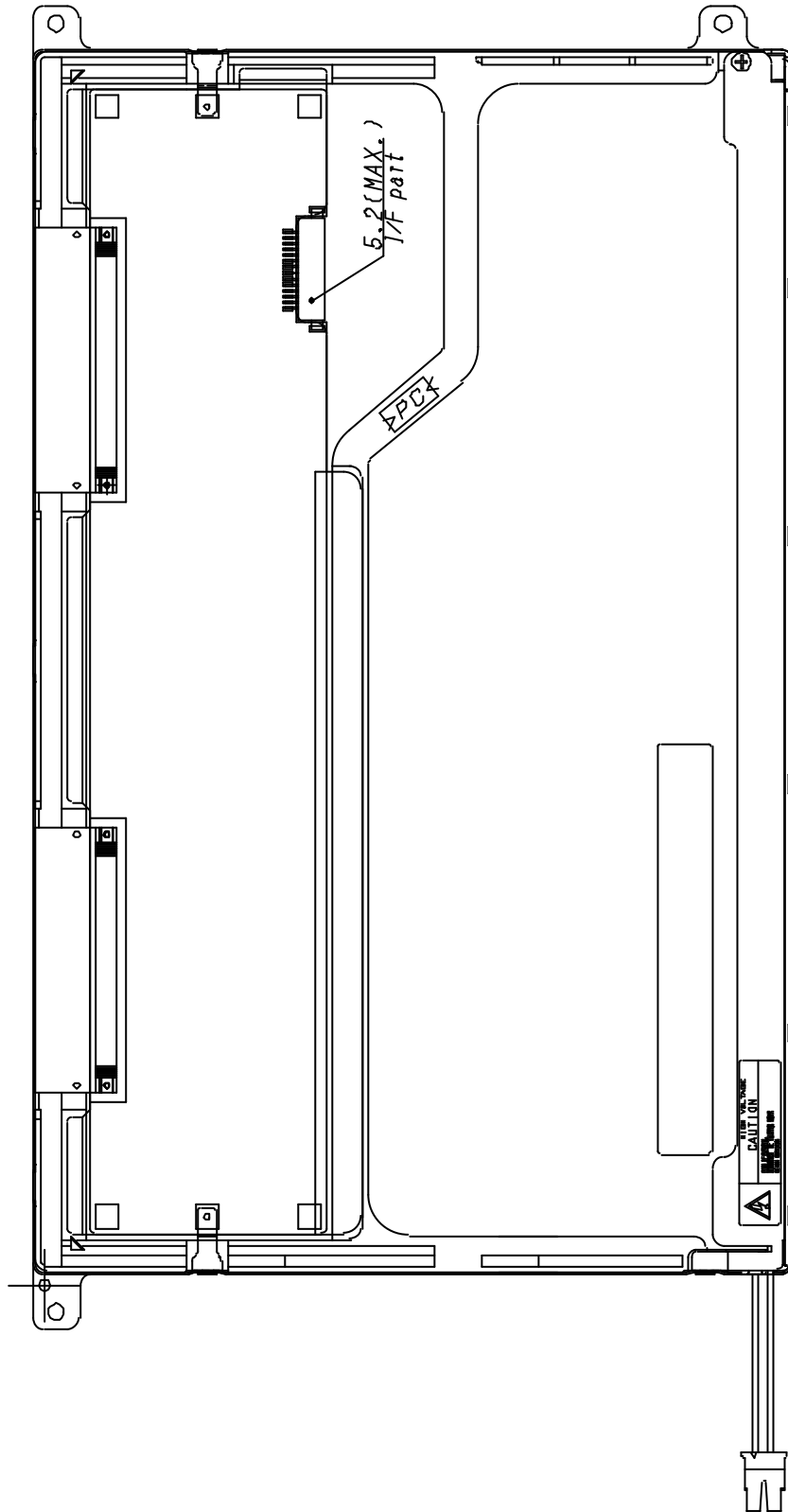

BLOCK DIAGRAM

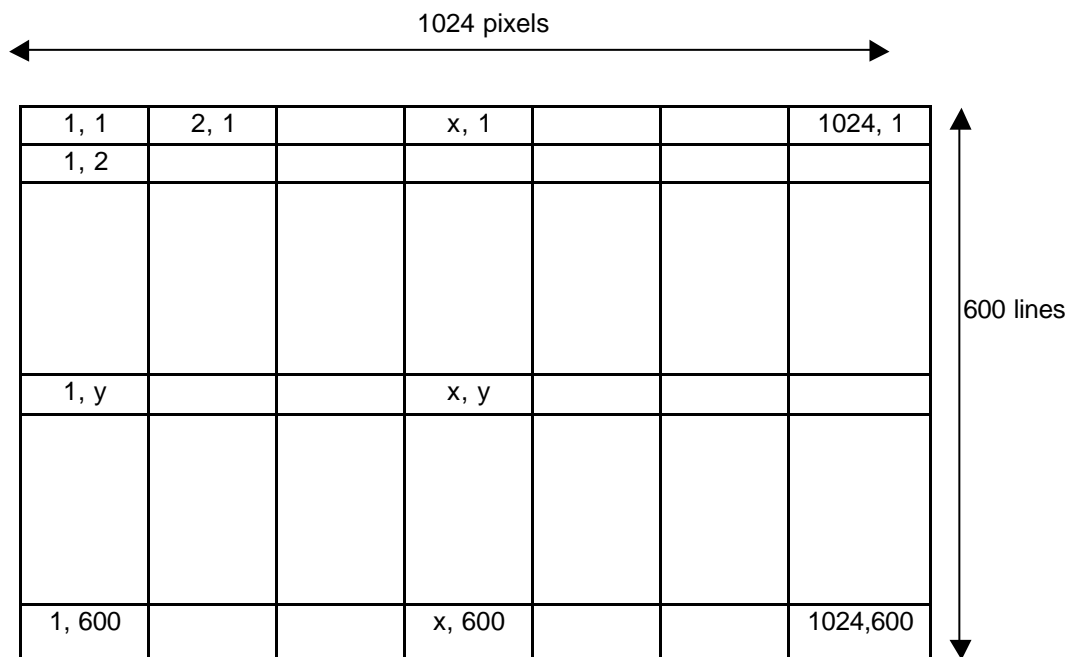
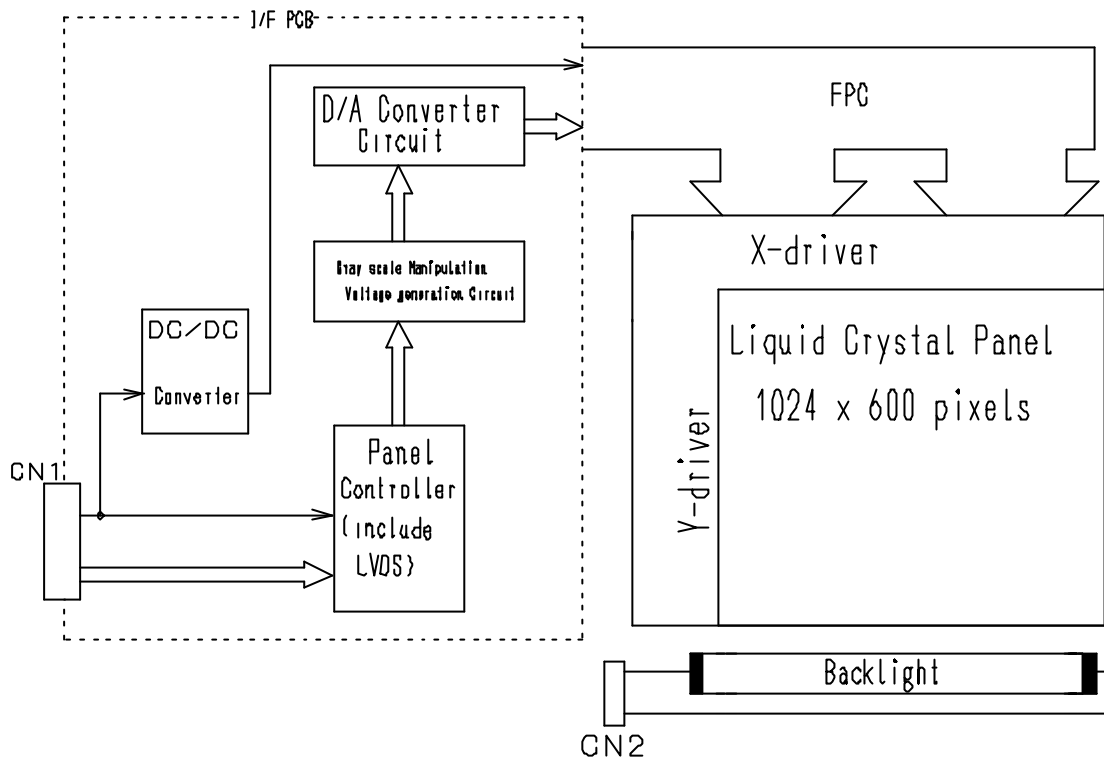

TIMING CHART

Horizontal Data Timing

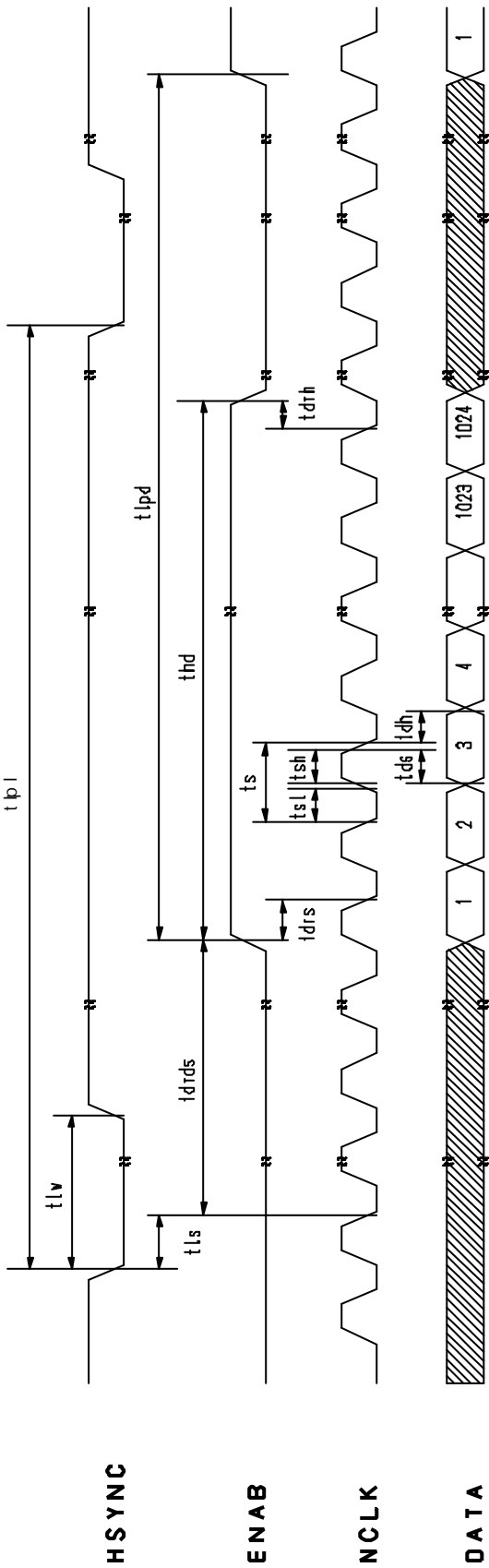

Vertical Data Timing

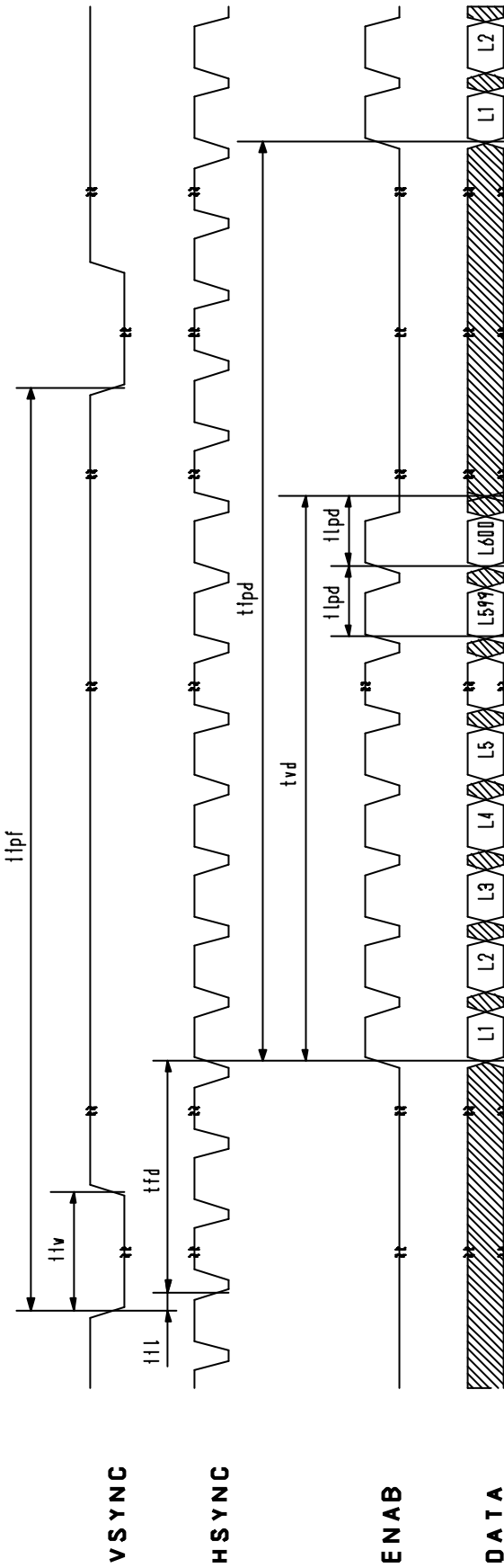

TIMING SPECIFICATION ^{1) 2) 3) 4) 5) 6)}

Signal	Parameter	Symbol	Min.	Typ.	Max.	Unit
NCLK	Frame Period	ts	19.0	19.84	-	ns
	Frequency	$1/ts$	-	50.4	52.6	MHz
	High Time	tsh	6	-	-	ns
	Low Time	tsl	7	-	-	ns
HSYNC	Setup to NCLK	tfs	7	-	-	ns
	Pulse Width	tlw	$8 \times ts$	-	-	-
VSYNC	Pulse Width	tfw	$3 \times tlpd$	-	$7 \times tlpd$	-
	VSYNC to DATA	$tfid$	$7 \times tlpd$	-	-	-
	Setup to HSYNC	tfl	16	-	-	ns
	Line Period	$tlpd=tlpl$	$1320 \times ts$ 25.08	$1344 \times ts$ 26.67	$1344 \times ts$	- μs
	Horizontal Display Time	thd	$1024 \times ts$	$1024 \times ts$	$1024 \times ts$	-
	Frame Frequency	$1/tpd$	56	60	-	Hz
	Frame Period	$tpd=tpf$	$610 \times tlpd$	$625 \times tlpd$	$635 \times tlpd$	-
	Vertical Display Time	tvd	$600 \times tlpd$	$600 \times tlpd$	$600 \times tlpd$	-
DATA	Setup	tds	5	-	-	ns
	Hold	tdh	7	-	-	ns
DE	Setup	$tdrs$	10	-	-	ns
	Hold	$tdrh$	10	-	-	ns
	Display Start	$tdrds$	-	-	$400 \times ts$	-

Note 1) Refer to "Timing Chart" and LVDS (THC63LVDF84A-85) specifications by THine Electronics, Inc.

Note 2) If NCLK is fixed to "H" or "L" level for certain period while V_{DD} is supplied, the panel may be damaged.

Note 3) Please adjust LCD operating signal timing and FL driving frequency, to optimize the display quality.

There is a possibility that flicker is observed by the interference of LCD operating signal timing and FL driving condition (especially driving frequency), even if the condition satisfies above timing specifications.

Note 4) Do not make tv , $tvhd$ and $tvds$ fluctuate.

If tv , $tvhd$, and $tvds$ are fluctuate, the panel displays black.

Note 5) In case of using the long frame period, the deterioration of display quality, noise etc. may be occurred.

Note 6) NCLK count of each Horizontal Scanning Time should be always the same.

V-Blanking period should be " n " X "Horizontal Scanning Time". (n : integer)

Frame period should be always the same.

CONNECTOR PIN ASSIGNMENT FOR INTERFACECN1 INPUT SIGNAL

Connector : DF19L-14P-1H / HIROSE

Matching Connector : DF19G-14S-1C / HIROSE

Terminal No.	Symbol	Function
1	V _{DD}	Power Supply : +3.3V
2	V _{DD}	Power Supply : +3.3V
3	GND	GND
4	GND	GND
5	RxIN0-	Negative LVDS differential data input (R0-R5,G0)
6	RxIN0+	Positive LVDS differential data input (R0-R5,G0)
7	RxIN1-	Negative LVDS differential data input (G1-G5, B0-B1)
8	RxIN1+	Positive LVDS differential data input (G1-G5, B0-B1)
9	RxIN2-	Negative LVDS differential data input (B2-B5, HS, VS, DE)
10	RxIN2+	Positive LVDS differential data input (B2-B5, HS, VS, DE)
11	CLK-	Clock Signal(-)
12	CLK+	Clock Signal(+)
13	GND	GND
14	GND	GND

Note 1) Please connect GND pin to ground. Don't use it as no-connect nor connectiton with high impedance.

CN2 CCFL POWER SOURCE

Connector : BHSR-02VS-1 / JAPAN SOLDERLESS TERMINAL MFG CO., LTD.

Matching Connector : SM02B-BHSS-1 / JAPAN SOLDERLESS TERMINAL MFG CO., LTD.

Terminal No.	Symbol	Function
1	V _{FLH}	CCFL Power Supply (high voltage)
2	V _{FLL}	CCFL Power Supply (low voltage)

**RECOMMENDED TRANSMITTER (THC63LVDF63A, THC63LVDM63A, THC63LVDM63A-85)
TO LTM09C362S INTERFACE ASSIGNMENT**

Case1: 6bit Transmitter

THC63LVDF63A, THC63LVDM63A, THC63LVDM63A-85				LTM09C362S Interface (CN1)		
Input Terminal No.		Input Signal (Graphics controller output signal)		Output Signal Symbol	Terminal	Symbol
Symbol	Terminal	Symbol	Function			
TA0	44	R0	Red Pixels Display Data (LSB)	TA- TA+	No.5 No.6	RxIN0- RxIN0+
TA1	45	R1	Red Pixels Display Data			
TA2	47	R2	Red Pixels Display Data			
TA3	48	R3	Red Pixels Display Data			
TA4	1	R4	Red Pixels Display Data			
TA5	3	R5	Red Pixels Display Data (MSB)			
TA6	4	G0	Green Pixels Display Data (LSB)			
TB0	6	G1	Green Pixels Display Data	TB- TB+	No.7 No.8	RxIN1- RxIN1+
TB1	7	G2	Green Pixels Display Data			
TB2	9	G3	Green Pixels Display Data			
TB3	10	G4	Green Pixels Display Data			
TB4	12	G5	Green Pixels Display Data (MSB)			
TB5	13	B0	Blue Pixels Display Data (LSB)			
TB6	15	B1	Blue Pixels Display Data			
TC0	16	B2	Blue Pixels Display Data	TC- TC+	No.9 No.10	RxIN2- RxIN2+
TC1	18	B3	Blue Pixels Display Data			
TC2	19	B4	Blue Pixels Display Data			
TC3	20	B5	Blue Pixels Display Data (MSB)			
TC4	22	HSYNC	Horizontal Synchronization Signal			
TC5	23	VSYNC	Vertical Synchronization Signal			
TC6	25	DE	Compound Synchronization Signal			
CLK IN	26	CLK	Data Sampling Clock	TCLK- TCLK+	No.11 No.12	CLK- CLK+

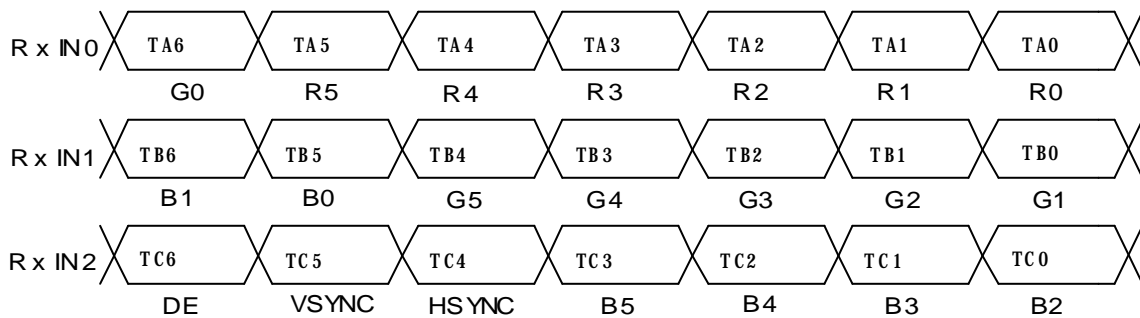

**RECOMMENDED TRANSMITTER (THC63LVDF83A,THC63LVDM83A,THC63LVDM83A-85)
TO LTM09C362S INTERFACE ASSIGNMENT**

Case2: 8bit Transmitter

THC63LVDF83A,THC63LVDM83A,THC63LVDM83A-85				LTM09C362S Interface (CN1)		
Input Terminal No.		Input Signal (Graphics controller output signal)		Output Signal Symbol	Terminal	Symbol
Symbol	Terminal	Symbol	Function			
TA0	51	R0	Red Pixels Display Data (LSB)	TA- TA+	No.5 No.6	RxIN0- RxIN0+
TA1	52	R1	Red Pixels Display Data			
TA2	54	R2	Red Pixels Display Data			
TA3	55	R3	Red Pixels Display Data			
TA4	56	R4	Red Pixels Display Data			
TA5	3	R5	Red Pixels Display Data (MSB)			
TA6	4	G0	Green Pixels Display Data(LSB)	TB- TB+	No.7 No.8	RxIN1- RxIN1+
TB0	6	G1	Green Pixels Display Data			
TB1	7	G2	Green Pixels Display Data			
TB2	11	G3	Green Pixels Display Data			
TB3	12	G4	Green Pixels Display Data			
TB4	14	G5	Green Pixels Display Data(MSB)			
TB5	15	B0	Blue Pixels Display Data (LSB)	TC- TC+	No.9 No.10	RxIN2- RxIN2+
TB6	19	B1	Blue Pixels Display Data			
TC0	20	B2	Blue Pixels Display Data			
TC1	22	B3	Blue Pixels Display Data			
TC2	23	B4	Blue Pixels Display Data			
TC3	24	B5	Blue Pixels Display Data (MSB)			
TC4	27	HSYNC	Horizontal Synchronization Signal	TD- TD+	-	-
TC5	28	VSYNC	Vertical Synchronization Signal			
TC6	30	DE	Compound Synchronization Signal			
TD0	50	NC	Non Connection (open)	TCLK- TCLK+	No.11 No.12	CLK- CLK+
TD1	2	NC	Non Connection (open)			
TD2	8	NC	Non Connection (open)			
TD3	10	NC	Non Connection (open)			
TD4	16	NC	Non Connection (open)			
TD5	18	NC	Non Connection (open)			
TD6	25	NC	Non Connection (open)			
CLK IN	31	CLK	Data Sampling Clock			

Note 1) Please connect NC pin to nothing. Don't connect it to ground nor to other signal input.

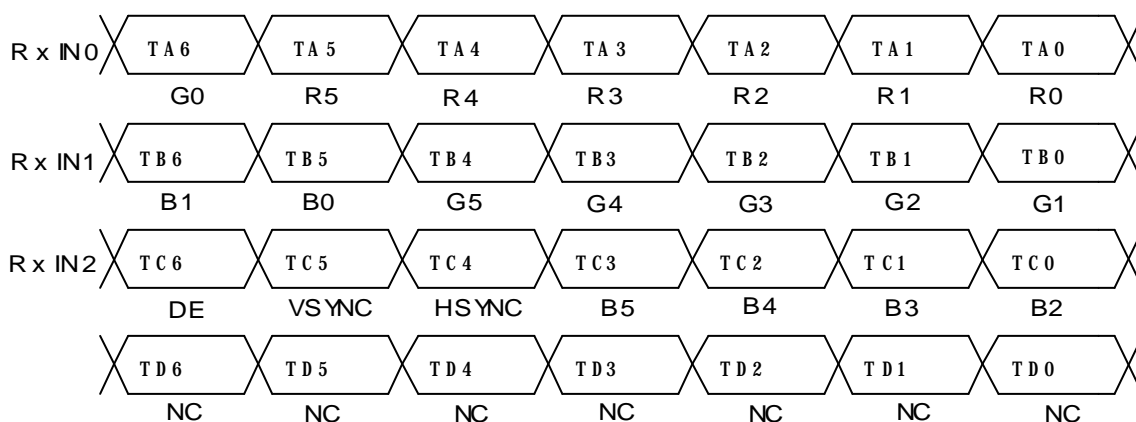

256k (k=1024) COLORS COMBINATION TABLE

	Display	R5 R4 R3 R2 R1 R0	G5 G4 G3 G2 G1 G0	B5 B4 B3 B2 B1 B0	Gray Scale Level
Basic Color	Black	L L L L L L	L L L L L L	L L L L L L	-
	Blue	L L L L L L	L L L L L L	H H H H H H	-
	Green	L L L L L L	H H H H H H	L L L L L L	-
	Light Blue	L L L L L L	H H H H H H	H H H H H H	-
	Red	H H H H H H	L L L L L L	L L L L L L	-
	Purple	H H H H H H	L L L L L L	H H H H H H	-
	Yellow	H H H H H H	H H H H H H	L L L L L L	-
	White	H H H H H H	H H H H H H	H H H H H H	-
Gray Scale of Red	Black	L L L L L L	L L L L L L	L L L L L L	L 0
	Dark ↑ ↓ Light	L L L L L H	L L L L L L	L L L L L L	L 1
		L L L L H L	L L L L L L	L L L L L L	L 2
		: :	: :	: :	L3... L60
		H H H H L H	L L L L L L	L L L L L L	L61
		H H H H H L	L L L L L L	L L L L L L	L62
	Red	H H H H H H	L L L L L L	L L L L L L	Red L63
	Gray Scale of Green	Black	L L L L L L	L L L L L L	L L L L L L
Dark ↑ ↓ Light		L L L L L L	L L L L L H	L L L L L L	L 1
		L L L L L L	L L L L H L	L L L L L L	L 2
		: :	: :	: :	L3... L60
		L L L L L L	H H H H L H	L L L L L L	L61
		L L L L L L	H H H H H L	L L L L L L	L62
Green		L L L L L L	H H H H H H	L L L L L L	Green L63
Gray Scale of Blue		Black	L L L L L L	L L L L L L	L L L L L L
	Dark ↑ ↓ Light	L L L L L L	L L L L L L	L L L L L H	L 1
		L L L L L L	L L L L L L	L L L L H L	L 2
		: :	: :	: :	L3... L60
		L L L L L L	L L L L L L	H H H H L H	L61
		L L L L L L	L L L L L L	H H H H H L	L62
	Blue	L L L L L L	L L L L L L	H H H H H H	Blue L63
	Gray Scale of White & Black	Black	L L L L L L	L L L L L L	L L L L L L
Dark ↑ ↓ Light		L L L L L H	L L L L L H	L L L L L H	L 1
		L L L L H L	L L L L H L	L L L L H L	L 2
		: :	: :	: :	L3... L60
		H H H H L H	H H H H L H	H H H H L H	L61
		H H H H H L	H H H H H L	H H H H H L	L62
White		H H H H H H	H H H H H H	H H H H H H	White L63

**FOR SAFETY**

LCD module is generally designed with precise parts to achieve light weighted thin mechanical dimensions. In using our Modules, make certain that you fully understand and put into practice the warnings and safety precautions detailed in Engineering Information No.EE-N001,"CAUTIONS AND INSTRUCTIONS FOR TOSHIBA LCD MODULES". Refer to individual specifications and TECHNICAL DATA sheets (hereinafter called "TD") for more detailed technical information.

1) SPECIAL PURPOSES

A) Toshiba Matsushita Display Technology's Standard LCD Modules have not been customized for operation in extreme environments or for use in applications where performance failures could be life-threatening or otherwise catastrophic.

B) Since Toshiba Matsushita Display Technology's Standard LCD Modules have not been designed for operation in extreme environments, they must never be used in devices that will be exposed to abnormally high levels of vibration or shock which exceed Toshiba Matsushita Display Technology's published specification limits.

C) In addition, since Toshiba Matsushita Display Technology Standard LCD Modules have not been designed for use in applications where performance failures could be life-threatening or catastrophic, they must never be installed in aircraft navigation control systems (such as, but not limited to Traffic Collision Avoidance System and Air Traffic Indicator), in military defense or weapons systems, in critical industrial process-control systems (e.g., those involved in the production of nuclear energy), or in critical medical device or patient life-support systems.

2) DISASSEMBLING OR MODIFICATION

DO NOT DISASSEMBLE OR MODIFY the module. It may damage sensitive parts inside LCD module, and may cause scratches or dust on the display.

Toshiba Matsushita Display Technology does not warrant the module, if customer disassembled or modified it.

3) BREAKAGE OF LCD PANEL

DO NOT INGEST liquid crystal material, DO NOT INHALE this material, and DO NOT CONTACT the material with skin, if LCD panel is broken and liquid crystal material spills out.

If liquid crystal material comes into mouth or eyes, rinse mouth or eyes out with water immediately.

If this material contact with skin or cloths, wash it off immediately with alcohol and rinse thoroughly with water.

4) GLASS OF LCD PANEL

BE CAREFUL WITH CHIPS OF GLASS that may cause injuring fingers or skin, when the glass is broken.

5) ELECTRIC SHOCK

DISCONNECT POWER SUPPLY before handling LCD module.

DO NOT TOUCH the parts inside LCD module and the fluorescent lamp's connector or cables in order to prevent electric shock, because high voltage is supplied to these parts from the inverter unit while power supply is turned on.

6) ABSOLUTE MAXIMUM RATINGS AND POWER PROTECTION CIRCUIT

DO NOT EXCEED the absolute maximum rating values under the worst probable conditions caused by the supply voltage variation, input voltage variation, variation in parts' constants, environmental temperature, etc., otherwise LCD module may be damaged.

Employ protection circuit for power supply, whenever the specification or TD specifies it.

Suitable protection circuit should be applied for each system design.

7) RECOMMENDED OPERATION CONDITIONS

The performance and quality of the LCD panel are warranted only when the LCD panel is used within "the recommended operation conditions". Toshiba Matsushita Display Technology Co., Ltd. never warrants the performance and quality of the LCD panel when you use the LCD panel over "the recommended operation conditions", although within "the absolute maximum rating".

To use the LCD panel over "the recommended operation conditions" may have bad influence on the characteristics and reliability of the LCD panel and may shorten the life of the LCD panel.

Therefore, when designing the whole set, not to be over "the recommended operation conditions", you should fully take care of supply voltage change, characteristic of connection parts, surge of input-and-output line, and surrounding temperature.

8) DISPOSAL

When dispose LCD module, obey to the applicable environmental regulations.