

SPECIFICATION FOR APPROVAL

- (◆) Preliminary Specification
 () Final Specification

Title	15.4" WXGA+ TFT LCD
-------	---------------------

Customer	Apple
MODEL	

SUPPLIER	LG Display Co., Ltd.
*MODEL	LP154WP4
Suffix	TLA1

*When you obtain standard approval,
 please use the above model name without suffix

APPROVED BY	SIGNATURE
/	_____
/	_____
/	_____

Please return 1 copy for your confirmation with your signature and comments.

APPROVED BY	SIGNATURE
J. K. Kim / S.Manager	_____
REVIEWED BY	
K. T. Moon / Manager	_____
PREPARED BY	
I. Y. Jung / Engineer	_____

**Products Engineering Dept.
 LG Display Co., Ltd**

Product Specification

Contents

No	ITEM	Page
	COVER	1
	CONTENTS	2
	RECORD OF REVISIONS	3
1	GENERAL DESCRIPTION	4
2	ABSOLUTE MAXIMUM RATINGS	5
3	ELECTRICAL SPECIFICATIONS	
3-1	ELECTRICAL CHARACTERISTICS	6
3-2	INTERFACE CONNECTIONS	7
3-3	LVDS SIGNAL TIMING SPECIFICATIONS	9
3-4	SIGNAL TIMING SPECIFICATIONS	11
3-5	SIGNAL TIMING WAVEFORMS	11
3-6	COLOR INPUT DATA REFERENCE	12
3-7	POWER SEQUENCE	13
4	OPTICAL SPECIFICATIONS	14
5	MECHANICAL CHARACTERISTICS	19
6	RELIABILITY	23
7	INTERNATIONAL STANDARDS	
7-1	SAFETY	24
7-2	EMC	24
8	PACKING	
8-1	DESIGNATION OF LOT MARK	25
8-2	PACKING FORM	25
9	PRECAUTIONS	26
A	APPENDIX A. Enhanced Extended Display Identification Data	28

1. General Description

The LP154WP4 is a Color Active Matrix Liquid Crystal Display with an integral LED backlight system. The matrix employs a-Si Thin Film Transistor as the active element. It is a transmissive type display operating in the normally white mode. This TFT-LCD has 15.4 inches diagonally measured active display area with WXGA+ resolution(1440 horizontal by 900 vertical pixel array). Each pixel is divided into Red, Green and Blue sub-pixels or dots which are arranged in vertical stripes. Gray scale or the brightness of the sub-pixel color is determined with a 6-bit gray scale signal for each dot, thus, presenting a palette of more than 262,144 colors.

The LP154WP4 has been designed to apply the interface method that enables low power, high speed, low EMI.

The LP154WP4 is intended to support applications where thin thickness, low power are critical factors and graphic displays are important. In combination with the vertical arrangement of the sub-pixels, the LP154WP4 characteristics provide an excellent flat display for office automation products such as Notebook PC.

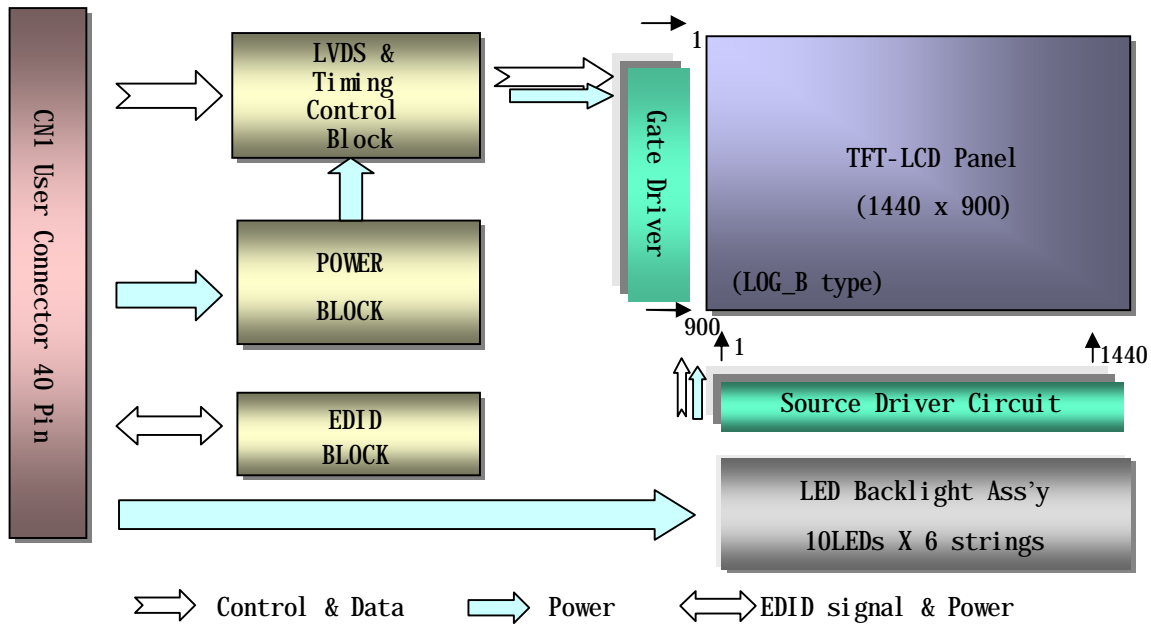

General Features

Active Screen Size	15.4 inches diagonal
Outline Dimension	342.85(H) × 220.84(V) × 4.03(D, Max.) mm
Pixel Pitch	0.2301 mm × 0.2301 mm
Pixel Format	1440 horiz. by 900 vert. Pixels RGB strip arrangement
Color Depth	6-bit, 262,144 colors
Luminance, White	330 cd/m ² (Typ., @I _{LED} =20mA), 160 points Average
Power Consumption	Total 5.06 Watt @ LCM circuit 1.1 Watt (Typ. Mosaic pattern), B/L 3.96 Watt
Weight	440g (Max.)
Display Operating Mode	Transmissive mode, normally white
Surface Treatment	Hard coating (glare) & Anti-Reflection treatment of the Front polarizer

2. Absolute Maximum Ratings

The following are maximum values which, if exceeded, may cause faulty operation or damage to the unit.

Table 1. ABSOLUTE MAXIMUM RATINGS

Parameter	Symbol	Values		Units	Notes
		Min	Max		
Power Input Voltage	VCC	-0.3	4.0	Vdc	at 25 ± 5°C
Operating Temperature	TOP	0	50	°C	1
Storage Temperature	HST	-20	60	°C	1
Operating Ambient Humidity	HoP	10	90	%RH	1
Storage Humidity	HST	10	90	%RH	1

Note : 1. Temperature and relative humidity range are shown in the figure below.
 Wet bulb temperature should be 39°C Max, and no condensation of water.

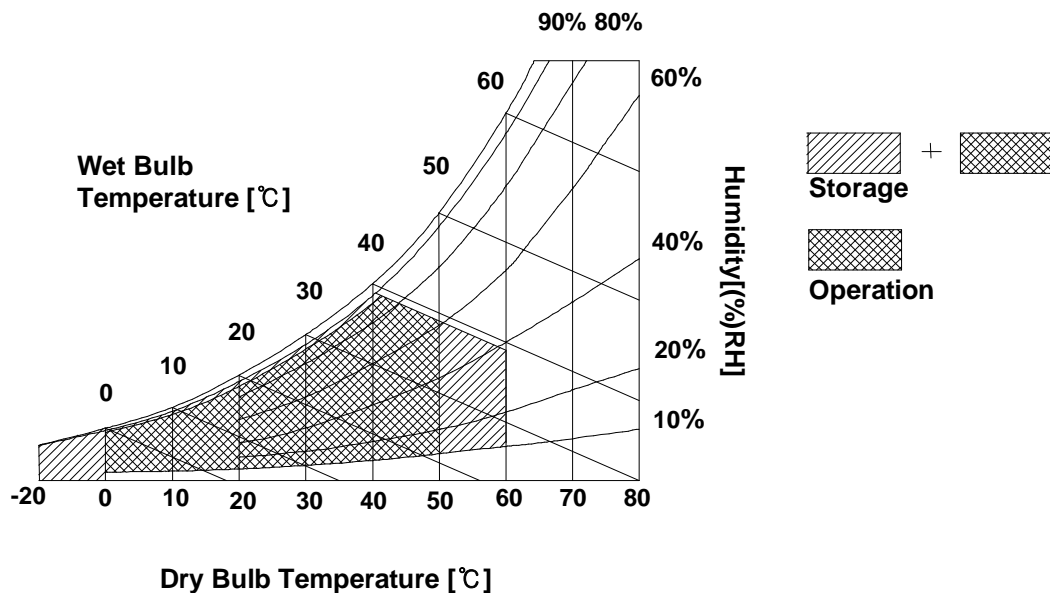

Product Specification

3. Electrical Specifications

3-1. Electrical Characteristics

The LP154WP4 requires two power inputs. One is employed to power the LCD electronics and to drive the TFT array and liquid crystal. The second input which powers the LED BL.

Table 2. ELECTRICAL CHARACTERISTICS

Parameter	Symbol	Values			Unit	Notes
		Min	Typ	Max		
MODULE :						
Power Supply Input Voltage	VCC	3.0	3.3	3.6	V _{DC}	
Power Supply Input Current	I _{CC} Mosaic	-	355	380	mA	1
Power Consumption	P _C	-	1.15	1.25	Watt	1
Differential Impedance	Z _m	90	100	110	Ohm	2
Inrush Current	I _{RUSH}	-	-	1.5	A	3
LED Backlight :						
Operating Voltage	V _{LED}	-	30	-	V	
Operating Current per string	I _{LED}	-	20	-	mA	4
Power Consumption	P _{BL}	-	3.96	-	Watt	5
Life Time		10,000	-	-	Hrs	6

Note)

- The specified current and power consumption are under the Vcc = 3.3V , 25°C , fv = 60Hz condition whereas Mosaic pattern is displayed and fv is the frame frequency.

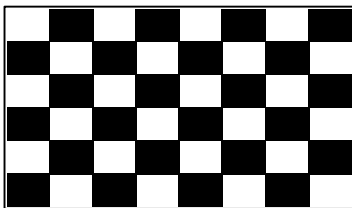

- This impedance value is needed to proper display and measured form LVDS Tx to the mating connector.
- The inrush current is measured under a maximum or minimum Vcc in black pattern.
- The typical operating current is for the typical surface luminance (L_{VH}) in optical characteristics. I_{LED} is the current of each LEDs' string, LED backlight has 6 strings on it.
- The LED power consumption shown above does not include power of external LED driver circuit for typical current condition.
- The life time is determined as the time at which brightness of LED is 50% compare to that of initial value at the typical LED current.

Product Specification

3-2. Interface Connections

This LCD employs two interface connections, a 40 pin connector is used for the module electronics interface and the other connector is used for the integral backlight system.

The electronics interface connector is a model 20474-040E-12 manufactured by I-PEX.

Table 3. MODULE CONNECTOR PIN CONFIGURATION (CN1)

Pin	Symbol	Description	Notes
1	GND	Ground	[LVDS Receiver] Magna chip, D10D40T642L [Connector] 20474-040E-12(I-PEX), 40pin [Connector pin arrangement] LCD rear view 
2	VCC	Power Supply, 3.3V Typ.	
3	VCC	Power Supply, 3.3V Typ.	
4	V EEDID	DDC 3.3V power	
5	Vsync	Vsync (GSP)	
6	Clk EEDID	DDC Clock	
7	DATA EEDID	DDC Data	
8	RA1-	Negative LVDS differential data input	
9	RA1+	Positive LVDS differential data input	
10	GND	Ground	
11	RB1-	Negative LVDS differential data input	
12	RB1+	Positive LVDS differential data input	
13	GND	Ground	
14	RC1-	Negative LVDS differential data input	
15	RC1+	Positive LVDS differential data input	
16	GND	Ground	
17	RCLK1-	Negative LVDS differential data input	
18	RCLK1+	Positive LVDS differential data input	
19	GND	Ground	
20	RA2-	Negative LVDS differential data input	
21	RA2+	Positive LVDS differential data input	
22	GND	Ground	
23	RB2-	Negative LVDS differential data input	
24	RB2+	Positive LVDS differential data input	
25	GND	Ground	
26	RC2-	Negative LVDS differential data input	
27	RC2+	Positive LVDS differential data input	
28	GND	Ground	
29	RCLK2-	Negative LVDS differential data input	
30	RCLK2+	Positive LVDS differential data input	
31	Vdc1	LED Cathode (Negative)	
32	Vdc2	LED Cathode (Negative)	
33	Vdc3	LED Cathode (Negative)	
34	Vdc4	LED Cathode (Negative)	
35	Vdc5	LED Cathode (Negative)	
36	Vdc6	LED Cathode (Negative)	
37	NC	No Connection	
38	Vdc(123456)	LED Anode (Positive)	
39	Vdc(123456)	LED Anode (Positive)	
40	Vdc(123456)	LED Anode (Positive)	

Product Specification

Table 4. BACKLIGHT CONNECTOR PIN CONFIGURATION (CN2)

The LED backlight connector is a model TF12-9S-0.5H, manufactured by Hirose.

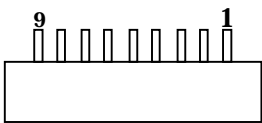
Pin	Symbol	Description	Notes
1	Vdc(1,2,3,4,5,6)	LED Anode(Positive)	
2	Vdc(1,2,3,4,5,6)	LED Anode(Positive)	
3	NC	No Connection	
4	Vdc1	LED Cathode (Negative)	
5	Vdc5	LED Cathode (Negative)	
6	Vdc3	LED Cathode (Negative)	
7	Vdc4	LED Cathode (Negative)	
8	Vdc5	LED Cathode (Negative)	
9	Vdc6	LED Cathode (Negative)	

Product Specification

3-3. LVDS Signal Timing Specifications

3-3-1. DC Specification

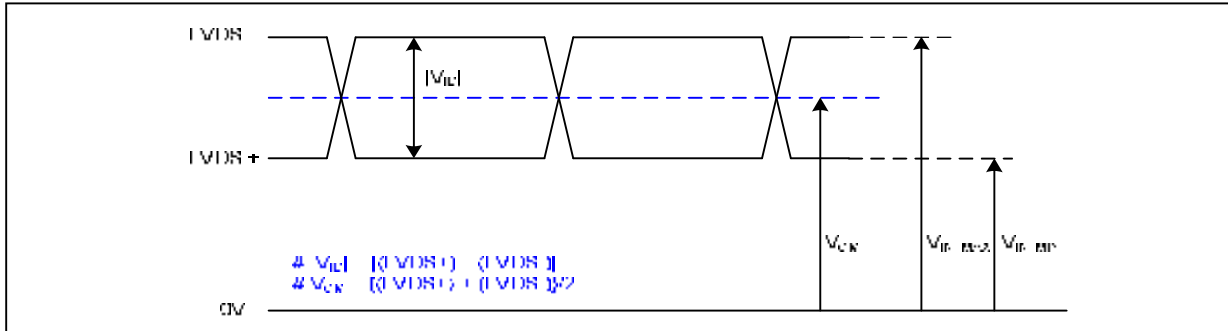

Description	Symbol	Min	Max	Unit	Notes
LVDS Differential Voltage	$ V_{ID} $	100	600	mV	-
LVDS Common mode Voltage	V_{CM}	0.6	1.8	V	-
LVDS Input Voltage Range	V_{IN}	0.3	2.1	V	-

3-3-2. AC Specification

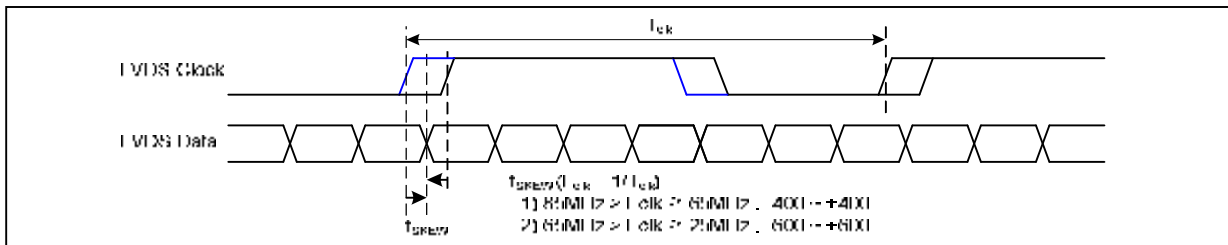

Description	Symbol	Min	Max	Unit	Notes
LVDS Clock to Data Skew Margin	t_{SKEW}	- 400	+ 400	ps	85MHz > Fclk ≥ 65MHz
	t_{SKEW}	- 600	+ 600	ps	65MHz > Fclk ≥ 25MHz
LVDS Clock to Clock Skew Margin (Even to Odd)	t_{SKEW_EO}	- 1/7	+ 1/7	T_{clk}	-
Maximum deviation of input clock frequency during SSC	F_{DEV}	-	± 3	%	-
Maximum modulation frequency of input clock during SSC	F_{MOD}	-	200	KHz	-

Product Specification

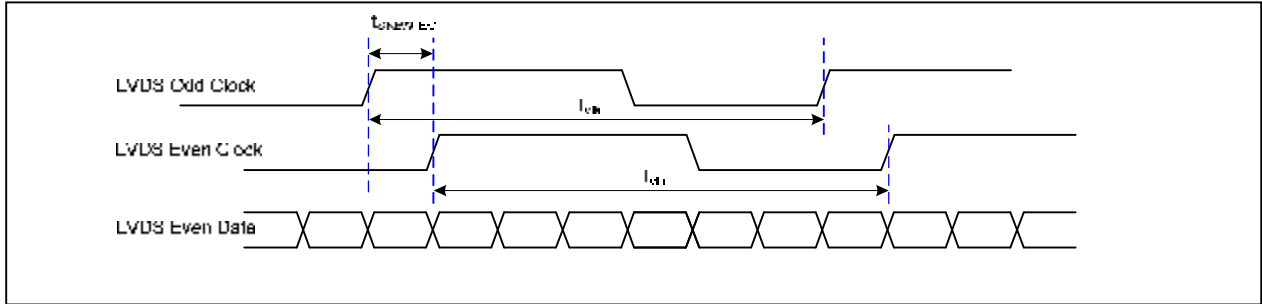

< Clock skew margin between channel >

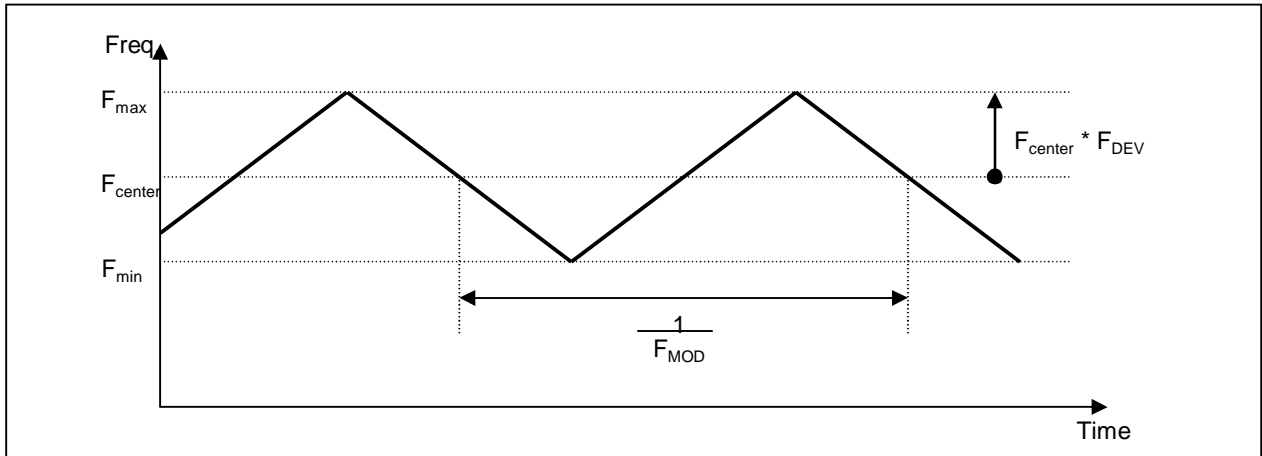

< Spread Spectrum >

3-3-3. Data Format

LVDS 2 Port

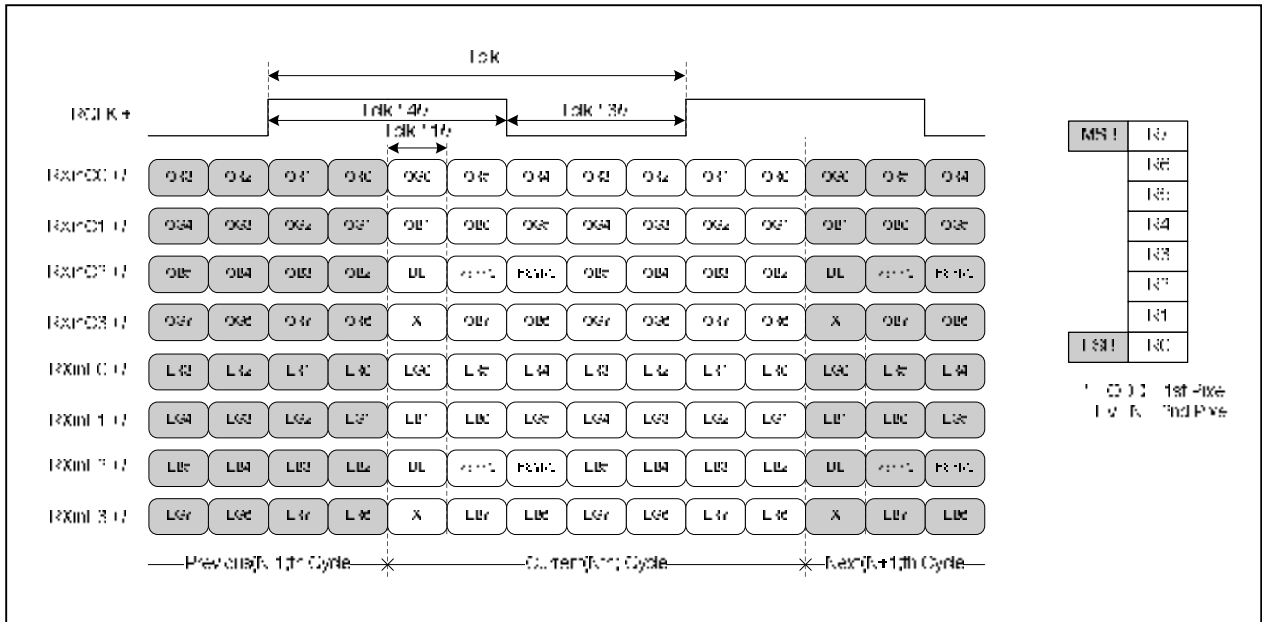

< LVDS Data Format >

Product Specification

3-4. Signal Timing Specifications

This is the signal timing required at the input of the User connector. All of the interface signal timing should be satisfied with the following specifications and specifications of LVDS Tx/Rx for its proper operation.

Table 5. TIMING TABLE

ITEM	Symbol	Min.	Typ.	Max.	Unit	Note
DCLK	Frequency	f_{CLK}	-	88.750	-	MHz
Hsync	Active	t_{WHA}	1440	1440	1440	tCLK
	Period	t_{HP}	1520	1600	1680	
	Width-Active	t_{WH}	24	32	40	
Vsync	Active	t_{WVA}	900	900	900	tHP
	Period	t_{VP}	911	926	938	
	Width-Active	t_{WV}	2	6	10	
Data Enable	Horizontal back porch	t_{HBP}	48	80	144	tCLK
	Horizontal front porch	t_{HFP}	8	48	56	
	Vertical back porch	t_{VBP}	7	17	23	tHP
	Vertical front porch	t_{VFP}	2	3	6	

3-5. Signal Timing Waveforms

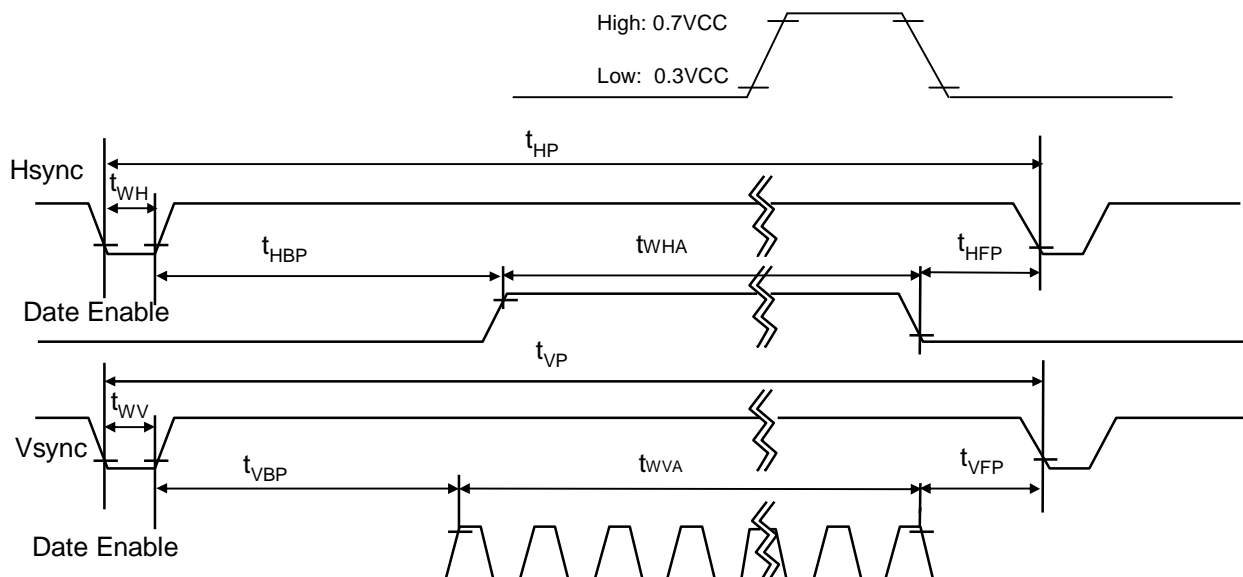
 Condition : $V_{CC} = 3.3V$

3-6. Color Input Data Reference

The brightness of each primary color (red, green and blue) is based on the 6-bit gray scale data input for the color ; the higher the binary input, the brighter the color. The table below provides a reference for color versus data input.

Table 6. COLOR DATA REFERENCE

Color		Input Color Data																	
		RED						GREEN						BLUE					
		MSB				LSB		MSB				LSB		MSB				LSB	
		R 5	R 4	R 3	R 2	R 1	R 0	G 5	G 4	G 3	G 2	G 1	G 0	B 5	B 4	B 3	B 2	B 1	B 0
Basic Color	Black	0	0	0	0	0	0	0	0	0	0	0	0	0	0	0	0	0	0
	Red	1	1	1	1	1	1	0	0	0	0	0	0	0	0	0	0	0	0
	Green	0	0	0	0	0	0	1	1	1	1	1	1	0	0	0	0	0	0
	Blue	0	0	0	0	0	0	0	0	0	0	0	0	1	1	1	1	1	1
	Cyan	0	0	0	0	0	0	1	1	1	1	1	1	1	1	1	1	1	1
	Magenta	1	1	1	1	1	1	0	0	0	0	0	0	1	1	1	1	1	1
	Yellow	1	1	1	1	1	1	1	1	1	1	1	1	0	0	0	0	0	0
	White	1	1	1	1	1	1	1	1	1	1	1	1	1	1	1	1	1	1
RED	RED (00)	0	0	0	0	0	0	0	0	0	0	0	0	0	0	0	0	0	0
	RED (01)	0	0	0	0	0	1	0	0	0	0	0	0	0	0	0	0	0	0
	...																		
	RED (62)	1	1	1	1	1	0	0	0	0	0	0	0	0	0	0	0	0	0
	RED (63)	1	1	1	1	1	1	0	0	0	0	0	0	0	0	0	0	0	0
GREEN	GREEN (00)	0	0	0	0	0	0	0	0	0	0	0	0	0	0	0	0	0	0
	GREEN (01)	0	0	0	0	0	0	0	0	0	0	0	1	0	0	0	0	0	0
	...																		
	GREEN (62)	0	0	0	0	0	0	1	1	1	1	1	0	0	0	0	0	0	0
	GREEN (63)	0	0	0	0	0	0	1	1	1	1	1	1	0	0	0	0	0	0
BLUE	BLUE (00)	0	0	0	0	0	0	0	0	0	0	0	0	0	0	0	0	0	0
	BLUE (01)	0	0	0	0	0	0	0	0	0	0	0	0	0	0	0	0	0	1
	...																		
	BLUE (62)	0	0	0	0	0	0	0	0	0	0	0	0	1	1	1	1	1	0
	BLUE (63)	0	0	0	0	0	0	0	0	0	0	0	0	1	1	1	1	1	1

3-7. Power Sequence

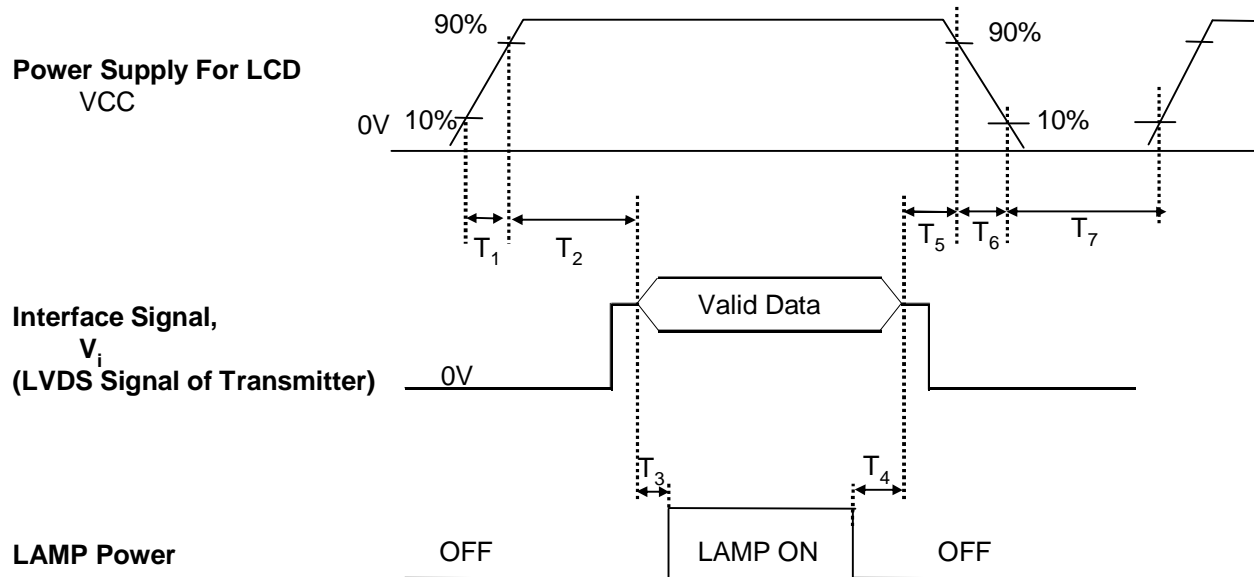

Table 7. POWER SEQUENCE TABLE

Parameter	Value			Units
	Min.	Typ.	Max.	
T ₁	-	-	10	(ms)
T ₂	0	-	50	(ms)
T ₃	200	-	-	(ms)
T ₄	200	-	-	(ms)
T ₅	0	-	50	(ms)
T ₆	0	-	10	(ms)
T ₇	400	-	-	(ms)

Note)

- Valid Data is Data to meet "3-3. LVDS Signal Timing Specifications"
- Please avoid floating state of interface signal at invalid period.
- When the interface signal is invalid, be sure to pull down the power supply for LCD VCC to 0V.
- Lamp power must be turn on after power supply for LCD and interface signal are valid.

4. Optical Specification

Optical characteristics are determined after the unit has been 'ON' and stable for approximately 20 minutes in a dark environment at 25°C. The values specified are at an approximate distance 50cm from the LCD surface at a viewing angle of Φ and Θ equal to 0°.

FIG. 1 presents additional information concerning the measurement equipment and method.

FIG. 1 Optical Characteristic Measurement Equipment and Method

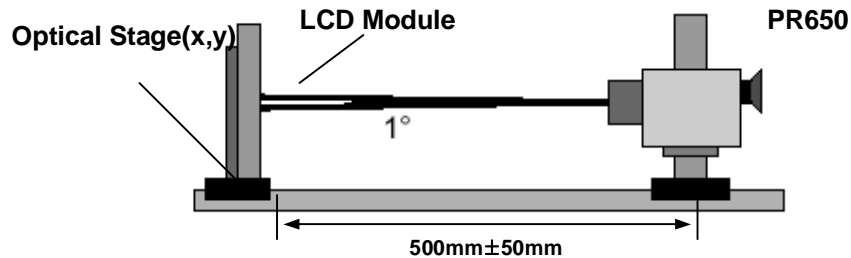

Table 8. OPTICAL CHARACTERISTICS

$T_a=25^\circ\text{C}$, $V_{CC}=3.3\text{V}$, $f_v=60\text{Hz}$, $f_{CLK}=88.75\text{MHz}$, $I_{LED} = 20\text{mA}$

Parameter	Symbol	Condition	Values			Units	Notes	
			Min	Typ	Max			
Average Luminance	L_{AVE}	160 Points ($I_{LED}=18\text{mA}$)	280	330		cd/m^2	Fig 2	
Luminance variation	%	160 points	60	70		-	Fig 2	
C/R	-	Center 1 Point	600	800		-		
Response time	$Tr_R + Tr_D$	-	-	16	25	ms	Fig 3	
Viewing angle	Horizontal	Θ	ϕ_x (Left, Right)	± 65	± 70	-	°	Fig 4
	Vertical	Θ	ϕ_{yu} (Up)	50	60	-		
		Θ	ϕ_{yd} (Down)	50	60	-		
Worst neighbor Brightness uniformity	%		70					
White chromaticity deviation (W.R.T center)		$d_{u'v'}$	-	-	0.008			
White chromaticity deviation (Over panel)		$d_{u'v'}$	-	-	0.0084			
White chromaticity deviation (Worst neighbor)		$d_{u'v'}$	-	-	0.0025			
Cross Talk	D_{SHA}	-	-	-	4.0	%	Fig 5	
Gray Scale	-	-			-			

Product Specification

Table 9. RGB Color Chromaticity

	White		Red		Green		Blue	
	W _x	W _y	R _x	R _y	G _x	G _y	B _x	B _y
Max.	0.343	0.359	TBD	TBD	TBD	TBD	TBD	TBD
Typ.	0.313	0.329	TBD	TBD	TBD	TBD	TBD	TBD
Min.	0.283	0.299	TBD	TBD	TBD	TBD	TBD	TBD

Notes)

1. Contrast Ratio(CR) is defined mathematically as

$$\text{Contrast Ratio} = \frac{\text{Surface Luminance with all white pixels}}{\text{Surface Luminance with all black pixels}}$$

2. Response time is the time required for the display to transition from white to black (rise time, Tr_R) and from black to white(Decay Time, Tr_D). For additional information see FIG 3.
3. Viewing angle is the angle at which the contrast ratio is greater than 10. The angles are determined for the horizontal or x axis and the vertical or y axis with respect to the z axis which is normal to the LCD surface. For more information see FIG 4.
4. Gray scale specification * f_v=60Hz

Gray Level	Luminance [%] (Typ)
L0	0.00
L7	0.80
L15	4.25
L23	10.9
L31	21.0
L39	34.8
L47	52.5
L55	74.2
L63	100

Product Specification

5. Average Luminance

$$\text{Ave.} = \text{SUM}(L1:L160) / 160$$

where L1 to L160 are the luminance values measured at point #1 to #160.

6. Luminance Uniformity

Luminance Uniformity:

$$U = 100\% - (L_{\text{max}} - L_{\text{min}}) / L_{\text{max}}$$

where, $L_{\text{max}} = \max \{\text{Luminance values at 160 points}\}$,

$L_{\text{min}} = \min \{\text{Luminance values at 160 points}\}$

7. Worst neighbor Luminance Uniformity

Worst Neighbor Luminance Uniformity (The 4 points that are closest to the test point)

$$\text{WNU} = 100\% - \text{Max}(\Delta L1, \Delta L2, \Delta L3, \Delta L4) / L0$$

Global WNU = $\min(\text{WNU1}, \dots, \text{WNU160})$

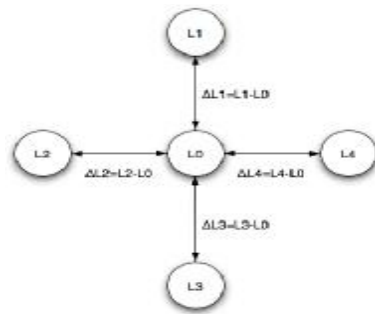

8. White chromaticity deviation – with respect to center

Center color coordinate is defined as the Average of points: 72, 73, 88, 89.

9. White chromaticity deviation – over panel

Maximum delta $u'v'$ between any two measured points over the 160 points

10. White chromaticity deviation – worst neighbor

Maximum delta $u'v'$ between any two neighboring points on the panel

11. White Chromaticity

Average (72, 73, 88, 89 Points)

12. RGB Chromaticity

Center Point

FIG. 2 Luminance

<Measuring point for Average Luminance & measuring point for Luminance variation>

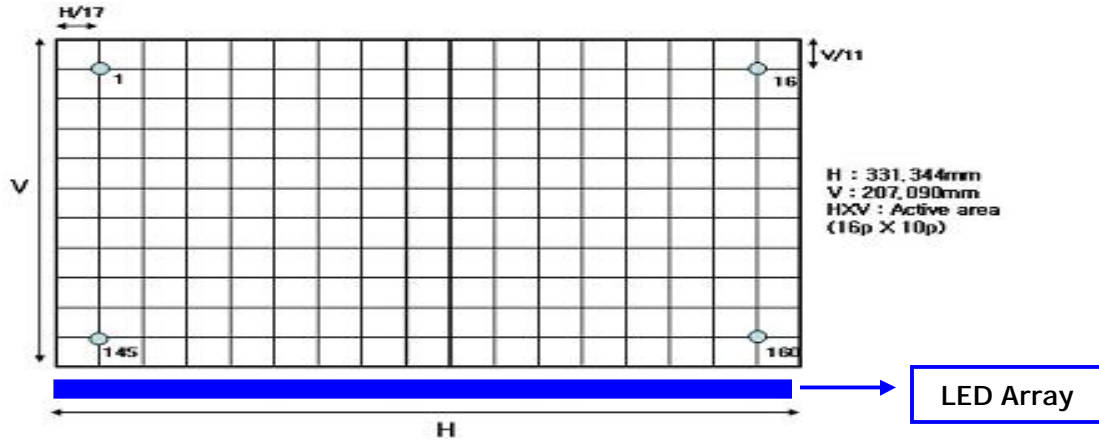

FIG. 3 Response Time

The response time is defined as the following figure and shall be measured by switching the input signal for "black" and "white".

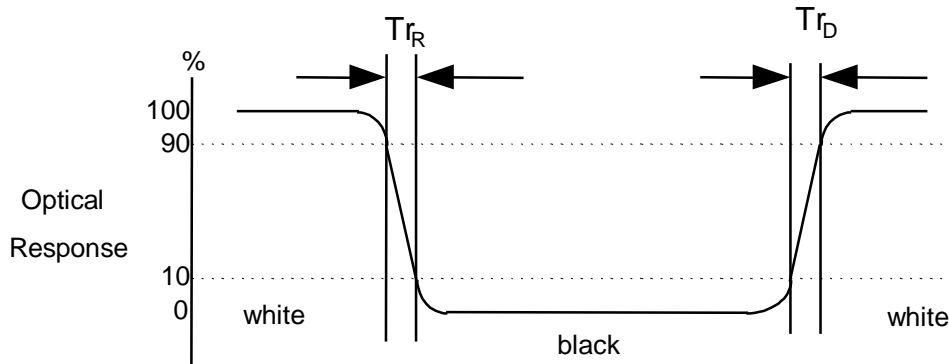

FIG. 4 Viewing angle

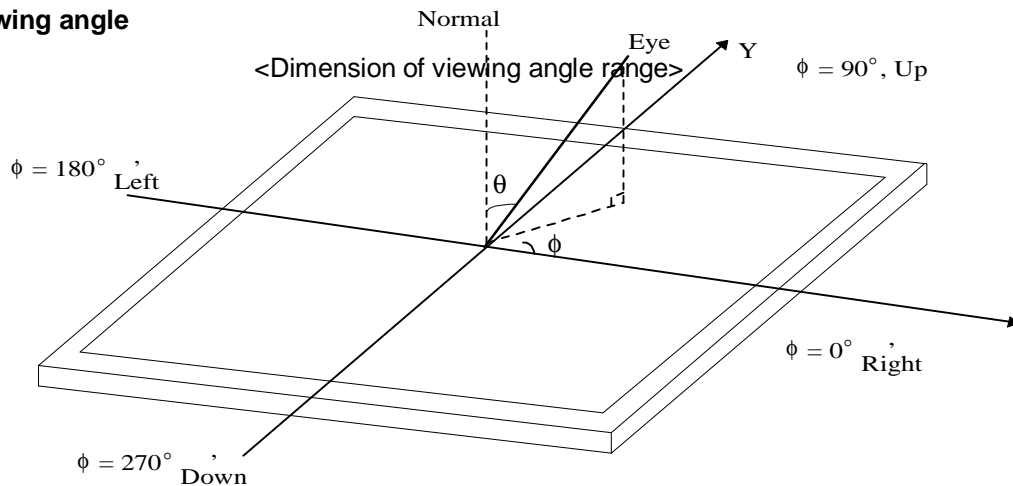

FIG. 5 Cross talk

No visual cross-talk will be allowed. Two luminance values are measured at center spot with 50 x 50 pixels. The cross-talk, D_{SHA} , is defined as,

$$D_{SHA} = (L_B - L_A) / L_B \cdot 100\%$$

Where, L_A = Luminance in Pattern A

L_B = Luminance in Pattern B.

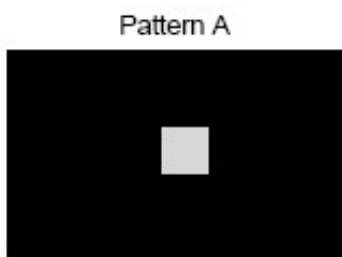

Pattern A
Gray Scale = 31 in center
Black in surrounding area

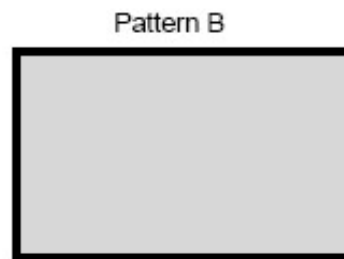

Pattern B
Gray Scale = 31 full screen

Product Specification

5. Mechanical Characteristics

The contents provide general mechanical characteristics for the model LP154WP4.
 In addition the figures in the next page are detailed mechanical drawing of the LCD.

Outline Dimension	Horizontal	342.85 ± 0.30mm
	Vertical	220.84 ± 0.30mm
	Depth	4.03mm(Max)
Polarizer Area	Horizontal	334.54mm
	Vertical	210.29mm
Active Display Area	Horizontal	331.344mm
	Vertical	207.090mm
Weight	440g (Max.)	
Surface Treatment	Hard coating (glare) & Anti-Reflection treatment of the Front polarizer	

Product Specification

<FRONT VIEW>

Note) Unit:[mm], General tolerance: ± 0.5 mm

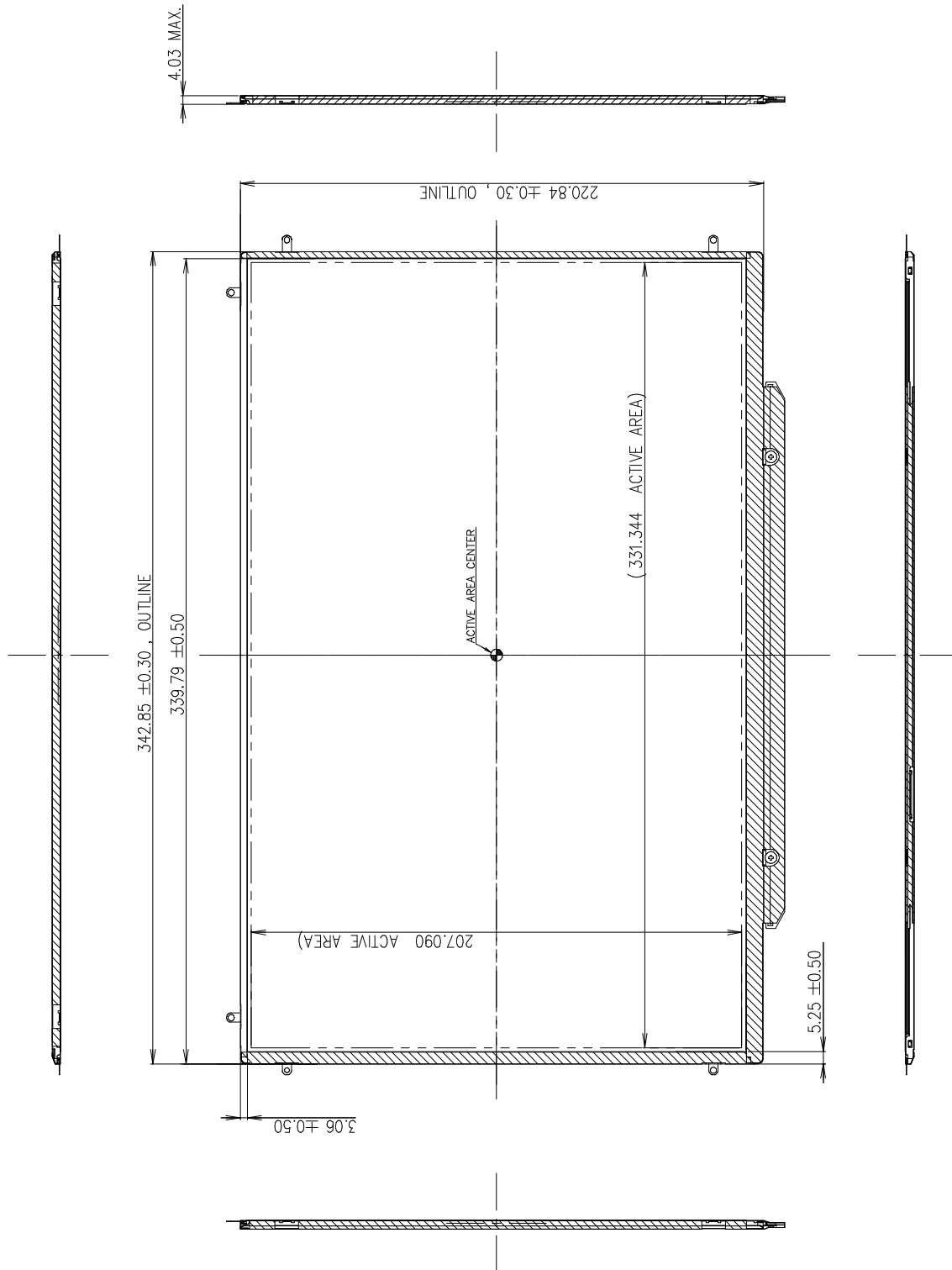

Product Specification

<REAR VIEW>

Note) Unit:[mm], General tolerance: $\pm 0.5\text{mm}$

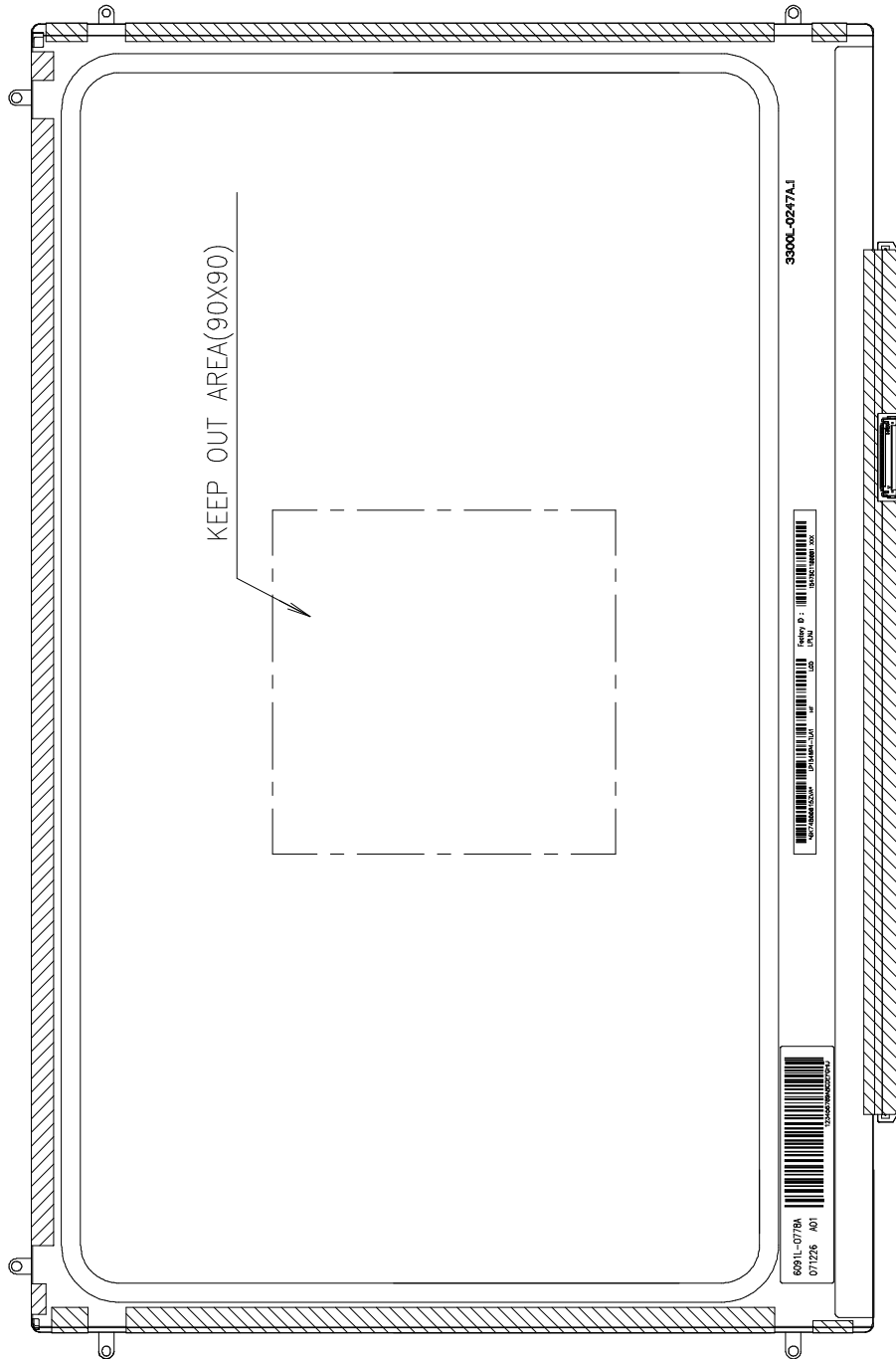

Product Specification

6. Reliability

Environment test condition

No.	Test Item	Conditions
1	High temperature storage test	Ta= 60°C, 240h
2	Low temperature storage test	Ta= -20°C, 240h
3	High temperature operation test	Ta= 50°C, 50%RH, 240h
4	Low temperature operation test	Ta= 0°C, 240h
5	Vibration test (non-operating)	Sine wave, 5 ~ 150Hz, 1.5G, 0.37oct/min 3 axis, 30min/axis
6	Shock test (non-operating)	- No functional or cosmetic defects following a shock to all 6 sides delivering at least 180 G in a half sine pulse no longer than 2 ms to the display module - No functional defects following a shock delivering at least 200 g in a half sine pulse no longer than 2 ms to each of 6 sides. Each of the 6 sides will be shock tested with one each display, for a total of 6 displays
7	Altitude operating storage / shipment	0 ~ 10,000 feet (3,048m) 24Hr 0 ~ 40,000 feet (12,192m) 24Hr

{ Result Evaluation Criteria }

There should be no change which might affect the practical display function when the display quality test is conducted under normal operating condition.

7. International Standards

7-1. Safety

- a) UL 1950 Third Edition, Underwriters Laboratories, Inc. Jan. 28, 1995.
Standard for Safety of Information Technology Equipment Including Electrical Business Equipment.
- b) CAN/CSA C22.2 No. 950-95 Third Edition, Canadian Standards Association, Jan. 28, 1995.
Standard for Safety of Information Technology Equipment Including Electrical Business Equipment.
- c) EN 60950 : 1992+A1: 1993+A2: 1993+A3: 1995+A1: 1997+A11: 1997
IEC 950 : 1991+A1: 1992+A2: 1993+A3: 1995+A1: 1996
European Committee for Electrotechnical Standardization(CENELEC)
EUROPEAN STANDARD for Safety of Information Technology Equipment Including Electrical Business
Equipment.

7-2. EMC

- a) ANSI C63.4 "Methods of Measurement of Radio-Noise Emissions from Low-Voltage Electrical and Electrical Equipment in the Range of 9kHz to 40GHz. "American National Standards Institute(ANSI), 1992
- b) C.I.S.P.R "Limits and Methods of Measurement of Radio Interface Characteristics of Information Technology Equipment." International Special Committee on Radio Interference.
- c) EN 55022 "Limits and Methods of Measurement of Radio Interface Characteristics of Information Technology Equipment." European Committee for Electrotechnical Standardization.(CENELEC), 1998

Product Specification

8. Packing

8-1. Designation of Lot Mark

a) Lot Mark

A	B	C	D	E	F	G	H	I	J	K	L	M
---	---	---	---	---	---	---	---	---	---	---	---	---

A,B,C : SIZE(INCH)
 E : MONTH

D : YEAR
 F ~ M : SERIAL NO.

Note

1. YEAR

Year	2001	2002	2003	2004	2005	2006	2007	2008	2009	2010
Mark	1	2	3	4	5	6	7	8	9	0

2. MONTH

Month	Jan	Feb	Mar	Apr	May	Jun	Jul	Aug	Sep	Oct	Nov	Dec
Mark	1	2	3	4	5	6	7	8	9	A	B	C

b) Location of Lot Mark

Serial No. is printed on the label. The label is attached to the backside of the LCD module.
 This is subject to change without prior notice.

8-2. Packing Form

a) Package quantity in one box : 20pcs

b) Box Size : 480mm × W370mm × H296mm

9. PRECAUTIONS

Please pay attention to the followings when you use this TFT LCD module.

9-1. MOUNTING PRECAUTIONS

- (1) You must mount a module using holes arranged in four corners or four sides.
- (2) You should consider the mounting structure so that uneven force (ex. Twisted stress) is not applied to the module. And the case on which a module is mounted should have sufficient strength so that external force is not transmitted directly to the module.
- (3) Please attach the surface transparent protective plate to the surface in order to protect the polarizer. Transparent protective plate should have sufficient strength in order to resist external force.
- (4) You should adopt radiation structure to satisfy the temperature specification.
- (5) Acetic acid type and chlorine type materials for the cover case are not desirable because the former generates corrosive gas of attacking the polarizer at high temperature and the latter causes circuit break by electro-chemical reaction.
- (6) Do not touch, push or rub the exposed polarizers with glass, tweezers or anything harder than HB pencil lead. And please do not rub with dust clothes with chemical treatment. Do not touch the surface of polarizer for bare hand or greasy cloth. (Some cosmetics are detrimental to the polarizer.)
- (7) When the surface becomes dusty, please wipe gently with absorbent cotton or other soft materials like chamois soaks with petroleum benzene. Normal-hexane is recommended for cleaning the adhesives used to attach front / rear polarizers. Do not use acetone, toluene and alcohol because they cause chemical damage to the polarizer.
- (8) Wipe off saliva or water drops as soon as possible. Their long time contact with polarizer causes deformations and color fading.
- (9) Do not open the case because inside circuits do not have sufficient strength.

9-2. OPERATING PRECAUTIONS

- (1) The spike noise causes the mis-operation of circuits. It should be lower than following voltage :
 $V = \pm 200\text{mV}$ (Over and under shoot voltage)
- (2) Response time depends on the temperature. (In lower temperature, it becomes longer.)
- (3) Brightness depends on the temperature. (In lower temperature, it becomes lower.)
And in lower temperature, response time (required time that brightness is stable after turned on) becomes longer.
- (4) Be careful for condensation at sudden temperature change. Condensation makes damage to polarizer or electrical contacted parts. And after fading condensation, smear or spot will occur.
- (5) When fixed patterns are displayed for a long time, remnant image is likely to occur.
- (6) Module has high frequency circuits. Sufficient suppression to the electromagnetic interference shall be done by system manufacturers. Grounding and shielding methods may be important to minimize the interference.

9-3. ELECTROSTATIC DISCHARGE CONTROL

Since a module is composed of electronic circuits, it is not strong to electrostatic discharge. Make certain that treatment persons are connected to ground through wrist band etc. And don't touch interface pin directly.

9-4. PRECAUTIONS FOR STRONG LIGHT EXPOSURE

Strong light exposure causes degradation of polarizer and color filter.

9-5. STORAGE

When storing modules as spares for a long time, the following precautions are necessary.

- (1) Store them in a dark place. Do not expose the module to sunlight or fluorescent light. Keep the temperature between 5°C and 35°C at normal humidity.
- (2) The polarizer surface should not come in contact with any other object.
It is recommended that they be stored in the container in which they were shipped.

9-6. HANDLING PRECAUTIONS FOR PROTECTION FILM

- (1) When the protection film is peeled off, static electricity is generated between the film and polarizer.
This should be peeled off slowly and carefully by people who are electrically grounded and with well ion-blown equipment or in such a condition, etc.
- (2) The protection film is attached to the polarizer with a small amount of glue. If some stress is applied to rub the protection film against the polarizer during the time you peel off the film, the glue is apt to remain on the polarizer.
Please carefully peel off the protection film without rubbing it against the polarizer.
- (3) When the module with protection film attached is stored for a long time, sometimes there remains a very small amount of glue still on the polarizer after the protection film is peeled off.
- (4) You can remove the glue easily. When the glue remains on the polarizer surface or its vestige is recognized, please wipe them off with absorbent cotton waste or other soft material like chamois soaked with normal-hexane.

Product Specification

APPENDIX A. Enhanced Extended Display Identification Data (EEDID™) 1/3

	Byte (dec)	Byte (hex)	Field Name and Comments	Value (hex)	Value (binary)
Header	0	00	Header	00	00000000
	1	01	Header	FF	11111111
	2	02	Header	FF	11111111
	3	03	Header	FF	11111111
	4	04	Header	FF	11111111
	5	05	Header	FF	11111111
	6	06	Header	FF	11111111
Vendor / Product EDID Version	7	07	Header	00	00000000
	8	08	EISA manufacture code (3 Character ID) APP	06	00000110
	9	09	EISA manufacture code (Compressed ASC II)	10	00010000
	10	0A	Panel Supplier Reserved - Product Code 9ca3	A3	10100011
	11	0B	(Hex. LSB first)	9C	10011100
	12	0C	LCD Module Serial No - Preferred but Optional ("0" If not used)	00	00000000
	13	0D	LCD Module Serial No - Preferred but Optional ("0" If not used)	00	00000000
	14	0E	LCD Module Serial No - Preferred but Optional ("0" If not used)	00	00000000
	15	0F	LCD Module Serial No - Preferred but Optional ("0" If not used)	00	00000000
	16	10	Week of Manufacture : 00 weeks	00	00000000
Display Parameters	17	11	Year of Manufacture 2009 year	13	00010011
	18	12	EDID structure version # = 1	01	00000001
	19	13	EDID revision # = 3	03	00000011
	20	14	Video input Definition = Digital signal	80	10000000
Panel Color Coordinates	21	15	Max H image size (Rounded cm) = 33 cm	21	00100001
	22	16	Max V image size (Rounded cm) = 21 cm	15	00010101
	23	17	Display gamma = (gamma*100)-100 = Example:(2.2*100)-100=120 = 2.2 Gamma	78	01111000
	24	18	Feature Support (no_DPMS, no_Active Off/Very Low Power, RGB color display, Timing BLK 1,no_GTF)	0A	00001010
	25	19	Red/Green Low Bits (RxRy/GxGy)	F5	11110101
	26	1A	Blue/White Low Bits (BxBy/WxWy)	95	10010101
	27	1B	Red X Rx = 0.640	A3	10100011
	28	1C	Red Y Ry = 0.335	55	01010101
	29	1D	Green X Gx = 0.310	4F	01001111
	30	1E	Green Y Gy = 0.610	9C	10011100
	31	1F	Blue X Bx = 0.150	26	00100110
	32	20	Blue Y By = 0.060	0F	00001111
	33	21	White X Wx = 0.313	50	01010000
	34	22	White Y Wy = 0.329	54	01010100
Establ ished Timin g	35	23	Established timing 1 (00h if nt used)	00	00000000
	36	24	Established timing 2 (00h if nt used)	00	00000000
Standard Timing ID	37	25	Manufacturer's timings (00h if nt used)	00	00000000
	38	26	Standard timing ID1 (01h if not used)	01	00000001
	39	27	Standard timing ID1 (01h if not used)	01	00000001
	40	28	Standard timing ID2 (01h if not used)	01	00000001
	41	29	Standard timing ID2 (01h if not used)	01	00000001
	42	2A	Standard timing ID3 (01h if not used)	01	00000001
	43	2B	Standard timing ID3 (01h if not used)	01	00000001
	44	2C	Standard timing ID4 (01h if not used)	01	00000001
	45	2D	Standard timing ID4 (01h if not used)	01	00000001
	46	2E	Standard timing ID5 (01h if not used)	01	00000001
	47	2F	Standard timing ID5 (01h if not used)	01	00000001
	48	30	Standard timing ID6 (01h if not used)	01	00000001
	49	31	Standard timing ID6 (01h if not used)	01	00000001
	50	32	Standard timing ID7 (01h if not used)	01	00000001
	51	33	Standard timing ID7 (01h if not used)	01	00000001
	52	34	Standard timing ID8 (01h if not used)	01	00000001
	53	35	Standard timing ID8 (01h if not used)	01	00000001

Product Specification

APPENDIX A. Enhanced Extended Display Identification Data (EEDID™) 2/3

	Byte (dec)	Byte (hex)	Field Name and Comments	Value (hex)	Value (binary)
Timing Descriptor #1	54	36	Pixel Clock/10,000 (LSB) 88.75 MHz @ 60Hz	AB	11010010
	55	37	Pixel Clock/10,000 (MSB)	22	100101
	56	38	Horizontal Active (lower 8 bits) 1440 Pixels	A0	10100000
	57	39	Horizontal Blanking(Thp-HA) (lower 8 bits) 160 Pixels	A0	111000
	58	3A	Horizontal Active / Horizontal Blanking(Thp-HA) (upper 4:4bits)	50	01010001
	59	3B	Vertical Active 900 Lines	84	10000100
	60	3C	Vertical Blanking (Tvp-HA) (DE Blanking typ.for DE only panels) 26 Lines	1A	10111
	61	3D	Vertical Active : Vertical Blanking (Tvp-HA) (upper 4:4bits)	30	00110000
	62	3E	Horizontal Sync. Offset (Thfp) 48 Pixels	30	01000000
	63	3F	Horizontal Sync Pulse Width (HSPW) 32 Pixels	20	00100000
	64	40	Vertical Sync Offset(Tvfp) : Sync Width (VSPW) 3 Lines : 6 Lines	36	00110011
	65	41	Horizontal Vertical Sync Offset/Width (upper 2bits)	00	00000000
	66	42	Horizontal Image Size (mm) 331 mm	4B	01001011
	67	43	Vertical Image Size (mm) 207 mm	CF	11001111
68	44	Horizontal Image Size / Vertical Image Size	10	00010000	
69	45	Horizontal Border = 0 (Zero for Notebook LCD)	00	00000000	
70	46	Vertical Border = 0 (Zero for Notebook LCD)	00	00000000	
71	47	Non-Interlace, Normal display, no stereo, Digital Separate (Vsync_NEG, Hsync_NEG)	18	00011000	
Timing Descriptor #2	72	48	Flag	00	00000000
	73	49	Flag	00	00000000
	74	4A	Flag	00	00000000
	75	4B	Data Type Tag (Descriptor Defined by manufacturer)	01	00000001
	76	4C	Flag (Version)	00	00000000
	77	4D	Descriptor Defined by manufacturer (Apple EDID signature) APP	06	00000110
	78	4E	Descriptor Defined by manufacturer (Apple EDID signature)	10	00010000
	79	4F	Descriptor Defined by manufacturer (Link Type)	30	00110000
	80	50	Descriptor Defined by manufacturer (Pixel and link component format_6bit panel interface)	00	00000000
	81	51	Descriptor Defined by manufacturer (Panel feature_Inverter NA, no Inverter)	00	00000000
	82	52	Descriptor Defined by manufacturer	00	00000000
	83	53	Descriptor Defined by manufacturer	00	00000000
	84	54	Descriptor Defined by manufacturer	00	00000000
	85	55	Descriptor Defined by manufacturer	00	00000000
86	56	Descriptor Defined by manufacturer	00	00000000	
87	57	Descriptor Defined by manufacturer	00	00000000	
88	58	Descriptor Defined by manufacturer	0A	00001010	
89	59	Descriptor Defined by manufacturer	20	00100000	
Timing Descriptor #3	90	5A	Flag	00	00000000
	91	5B	Flag	00	00000000
	92	5C	Flag	00	00000000
	93	5D	Data Type Tag (ASCII String)	FE	11111110
	94	5E	Flag	00	00000000
	95	5F	ASCII String L	4C	01001100
	96	60	ASCII String P	50	01010000
	97	61	ASCII String 1	31	00110001
	98	62	ASCII String 5	35	00110101
	99	63	ASCII String 4	34	00110100
	100	64	ASCII String W	57	01010111
	101	65	ASCII String P	50	01010000
	102	66	ASCII String 4	34	00110100
	103	67	ASCII String -	2D	00101101
104	68	ASCII String T	54	01010100	
105	69	ASCII String L	4C	01001100	
106	6A	ASCII String A	41	01000001	
107	6B	ASCII String 1	31	00110001	

APPENDIX A. Enhanced Extended Display Identification Data (EEDID™) 3/3

	Byte (dec)	Byte (hex)	Field Name and Comments	Value (HEX)	Value (binary)	
Timing Descriptor #4	108	6C	Flag	00	00000000	
	109	6D	Flag	00	00000000	
	110	6E	Flag	00	00000000	
	111	6F	Data Type Tag (ASCII String)	FE	11111110	
	112	70	Flag	00	00000000	
	113	71	ASCII String	C	01000011	
	114	72	ASCII String	o	01101111	
	115	73	ASCII String	l	01101100	
	116	74	ASCII String	o	01101111	
	117	75	ASCII String	r	01110010	
	118	76	ASCII String		20	00100000
	119	77	ASCII String	L	4C	01001100
	120	78	ASCII String	C	43	01000011
	121	79	ASCII String	D	44	01000100
	122	7A	ASCII String		0A	00001010
123	7B	ASCII String		20	00100000	
124	7C	ASCII String		20	00100000	
125	7D	ASCII String		20	00100000	
Chec	126	7E	Extension flag (# f optional 128 panel ID extension block to follow, Typ = 0)	00	00000000	
	127	7F	Check Sum (The 1-byte sum of all 128 bytes in this panel ID block shall = 0)	00	11000101	