

# NEC

## TFT COLOR LCD MODULE

### NL3224BC35-20

13.9cm (5.5 Type)

QVGA

DATA SHEET 

(3rd edition)

**PRELIMINARY**

All information is subject to change without notice.

*Published by*

1st Engineering Department

Color LCD Division

Display Device Operations Unit

NEC Electron Devices

2001 All rights reserved.

## INTRODUCTION

No part of this document shall be copied in any form or by any means without the prior written consent of NEC Corporation.

NEC Corporation does not assume any liability for infringement of patents, copyrights or other intellectual property rights of third parties by or arising from use of a product described herein or any other liability arising from use of such application. No license, express, implied or otherwise, is granted under any patents, copyrights or other intellectual property rights of NEC Corporation or of others.

While NEC Corporation has been making continuous effort to enhance the reliability of its products, the possibility of failures cannot be eliminated entirely. To minimize risks of damage to property or injury to person arising from a failure in an NEC product, customers must incorporate sufficient safety measures in their design, such as redundancy, fire-containment and anti-failure features.

NEC products are classified into the following three quality grades:

*"Standard", "Special", "Specific"*

The *"Specific"* quality grade applies only to applications developed based on a customer designated "quality assurance program" for a specific application. The recommended applications of a product depend on its quality grade, as indicated below. Customers must check the quality grade of each application before using it in a particular application.

***Standard:*** Computers, office equipment, communications equipment, test and measurement equipment, audio and visual equipment, home electronic appliances, machine tools, personal electronic equipment and industrial robots

***Special:*** Transportation equipment (automobiles, trains, ships, etc.), traffic control systems, anti-disaster systems, anti-crime systems, safety equipment and medical equipment (not specifically designed for life support)

***Specific:*** Military systems, aircraft, aerospace equipment, submersible repeaters, nuclear reactor control systems, life support systems (medical equipment, etc.) and any other equipment

The quality grade of this product is *"Standard"* unless otherwise specified in this document. If customers intend to use this product for applications other than those specified for *"Standard"* quality grade, they should contact NEC Corporation sales representative in advance.

Anti-radioactive design is not implemented in this product.

## CONTENTS

<b>INTRODUCTION .....</b>	<b>2</b>
<b>1. OUTLINE.....</b>	<b>5</b>
1.1 STRUCTURE AND PRINCIPLE .....	5
1.2 APPLICATIONS .....	5
1.3 FEATURES .....	5
<b>2. GENERAL SPECIFICATIONS .....</b>	<b>6</b>
<b>3. BLOCK DIAGRAM.....</b>	<b>7</b>
<b>4. DETAILED SPECIFICATIONS .....</b>	<b>8</b>
4.1 MECHANICAL SPECIFICATIONS.....	8
4.2 ABSOLUTE MAXIMUM RATINGS .....	8
4.3 ELECTRICAL CHARACTERISTICS.....	9
4.3.1 Driving for LCD panel signal processing board.....	9
4.3.2 Working for backlight lamp.....	9
4.3.3 Supply voltage ripple.....	10
4.3.4 Fuses .....	10
4.4 SUPPLY VOLTAGE SEQUENCE .....	11
4.4.1 Sequence for LCD panel signal processing board.....	11
4.4.2 Sequence for backlight inverter (Option) .....	11
4.5 CONNECTIONS AND FUNCTIONS FOR INTERFACE PINS .....	12
4.5.1 LCD panel signal processing board.....	12
4.5.2 Backlight lamp.....	13
4.5.3 Positions of sockets .....	13
4.6 DISPLAY COLORS AND INPUT DATA SIGNALS .....	14
4.7 DISPLAY POSITIONS .....	15
4.8 SCANNING DIRECTIONS.....	15
4.8.1 QVGA display mode.....	15
4.8.2 VGA display mode .....	16
4.9 INPUT SIGNAL TIMINGS FOR LCD PANEL SIGNAL PROCESSING BOARD.....	17
4.9.1 Outline of QVGA input signal timings .....	17
4.9.2 Outline of VGA input signal timings.....	18
4.9.3 Detailed QVGA input signal timing chart for DE mode.....	19
4.9.4 Detailed QVGA input signal timing chart for fixed mode.....	20
4.9.5 Detailed VGA input signal timing chart for DE mode.....	21
4.9.6 Detailed VGA input signal timing chart for fixed mode.....	22
4.9.7 Timing characteristics for QVGA display mode.....	23
4.9.8 Timing characteristics for VGA display mode.....	24
4.10 OPTICS .....	25
4.10.1 Optical characteristics.....	25
4.10.2 Definition of contrast ratio.....	26
4.10.3 Definition of luminance uniformity .....	26
4.10.4 Definition of response times .....	26
4.10.5 Definition of viewing angles .....	26

## CONTENTS

<b>5. RELIABILITY TESTS .....</b>	<b>27</b>
<b>6. PRECAUTIONS .....</b>	<b>28</b>
6.1 MEANING OF CAUTION SIGNS .....	28
6.2 CAUTIONS .....	28
6.3 ATTENTIONS .....	28
6.3.1 Handling of the product .....	28
6.3.2 Environment .....	28
6.3.3 Characteristics .....	29
6.3.4 Other .....	29
<b>7. OUTLINE DRAWINGS .....</b>	<b>30</b>
7.1 FRONT VIEW .....	30
7.2 REAR VIEW .....	31
<b>REVISION HISTORY .....</b>	<b>32</b>
1st edition .....	32
2nd edition .....	32
3rd edition .....	36

## 1. OUTLINE

### 1.1 STRUCTURE AND PRINCIPLE

NL3224BC35-20 module is composed of the amorphous silicon thin film transistor liquid crystal display (a-Si TFT LCD) panel structure with driver LSIs for driving the TFT (Thin Film Transistor) array and a backlight unit.

The a-Si TFT LCD panel structure is injected liquid crystal material into a narrow gap between the TFT array glass substrate and a color-filter glass substrate.

Color (Red, Green, Blue) data signals from a host system (e.g. PC, signal generator, etc.) are modulated into best form for active matrix system by a signal processing board, and sent to the driver LSIs which drive the individual TFT arrays.

The TFT array as an electro-optical switch regulates the amount of transmitted light from the backlight assembly, when it is controlled by data signals. Color images are created by regulating the amount of transmitted light through the TFT array of red, green and blue dots.

### 1.2 APPLICATIONS

- Industrial PC
- Display terminal for control system
- POS (Point of sale) terminal

### 1.3 FEATURES

- High luminance
- High color gamut
- Wide viewing angle
- Low reflection
- 6-bit digital RGB signals
- Reversible-scan direction
- Pixel selector
- Edge light type
- Replaceable lamp for backlight unit (Inverter less)

## 2. GENERAL SPECIFICATIONS

<b>Display area</b>	111.4 (W) × 83.5 (H) mm (typ.)
<b>Diagonal size of display</b>	13.9 cm (5.5 inches)
<b>Drive system</b>	a-Si TFT active matrix
<b>Display color</b>	262,144 colors
<b>Pixel</b>	At <i>QVGA display mode</i> 320 (H) × 240 (V) pixels  At <i>VGA display mode</i> 640 (H) × 480 (V) pixels
<b>Pixel arrangement</b>	RGB (Red dot, Green dot, Blue dot) vertical stripe
<b>Dot pitch</b>	0.1160 (W) × 0.3480 (H) mm
<b>Pixel pitch</b>	0.3480 (W) × 0.3480 (H) mm
<b>Module size</b>	134.0 (W) × 104.5 (H) × 12.5 (D) mm (typ.)
<b>Weight</b>	215 g (typ.)
<b>Contrast ratio</b>	300:1 (typ.)
<b>Viewing angle</b>	At the contrast ratio 10:1 <ul style="list-style-type: none"> <li>• Horizontal: Left side 65° (typ.), Right side 65° (typ.)</li> <li>• Vertical: Up side 65° (typ.), Down side 40° (typ.)</li> </ul>
<b>Designed viewing direction</b>	At <i>DPSH: normal scan and DPSV: normal scan</i> <ul style="list-style-type: none"> <li>• Viewing direction without image reversal: up side (12 o'clock)</li> <li>• Viewing direction with contrast peak: down side 5° to 10° (6 o'clock)</li> <li>• Viewing angle with optimum grayscale (<math>\gamma=2.2</math>): normal axis</li> </ul>
<b>Polarizer surface</b>	Antiglare treatment
<b>Polarizer pencil-hardness</b>	3H (min.) [by JIS K5400]
<b>Color gamut</b>	At <i>LCD panel center</i> 50 % (typ.) [against NTSC color space]
<b>Response time</b>	3 ms (typ.)
<b>Luminance</b>	At <i>5.0mArms / lamp</i> 400 cd/m <sup>2</sup> (typ.)
<b>Signal system</b>	6-bit digital signals for data of RGB colors, Dot clock (CLK), Data enable (DE), Horizontal synchronous signal (Hsync), Vertical synchronous signal (Vsync)
<b>Supply voltage</b>	LCD panel signal processing board: 3.3V or 5.0V
<b>Backlight</b>	Edge light type: 2 cold cathode fluorescent lamps  ( Replaceable parts ) • Lamps for backlight unit: Type No. 55LHS11  ( Recommended inverter (Option) ) • Inverter: Type No. 55PW131 )
<b>Power consumption</b>	At <i>maximum luminance and checkered flag pattern</i> 4.1 W (typ.)

3. BLOCK DIAGRAM

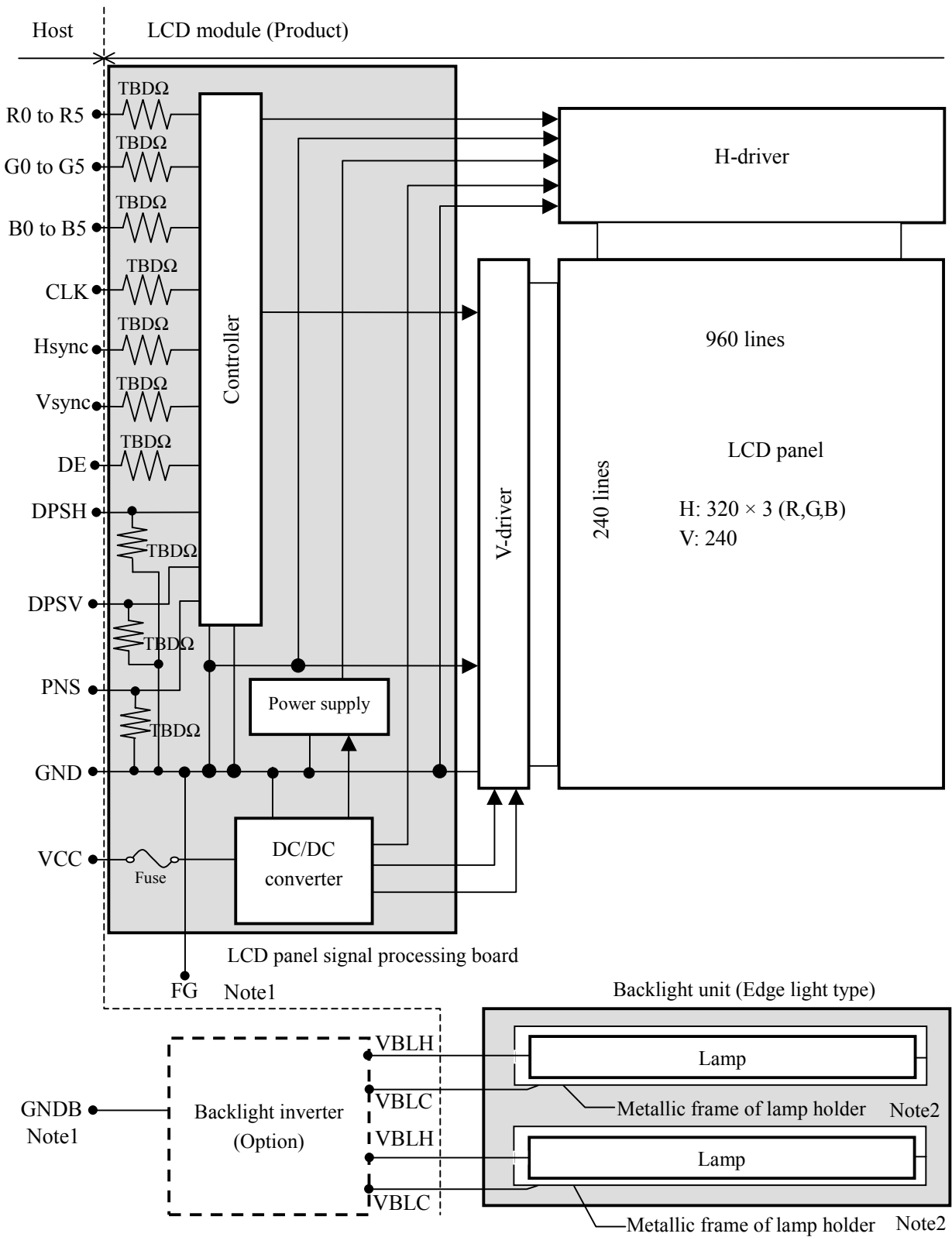

Note1: GND is connected to FG (Frame ground). GND and GNDB (Backlight inverter ground) should be connected together in customer equipment.

Note2: The metallic frame of lamp holder is used to a transmission line for VBLC.

## 4. DETAILED SPECIFICATIONS

### 4.1 MECHANICAL SPECIFICATIONS

Parameter	Specification	Unit
Module size	134.0 ± 0.5 (W) × 104.5 ± 0.5 (H) × 12.5 ± 0.5 (D) Note1	mm
Display area	111.4 ± 0.5 (W) × 83.5 ± 0.5 (H) Note1	mm
Weight	215 (typ.), 220 (max.)	g

Note1: See "7.OUTLINE DRAWINGS".

### 4.2 ABSOLUTE MAXIMUM RATINGS

Parameter		Symbol	Rating	Unit	Remarks	
Supply voltage	LCD panel signal board and driver		VCC	-0.3 to +6.5	V	Ta = 25°C
Input voltage	LCD panel signal board	Display signals Note1	VD	-0.3 to VCC+0.3	V	
		Function signals Note2	VF	-0.3 to VCC+0.3	V	
	Lamp	High voltage side (Hot) Note3	VBLH	1,500	Vrms	
		Low voltage side (Cold) Note4	VBLC	42.4	Vrms	
Storage temperature		Tst	-30 to +80	°C	-	
Operating temperature	Front surface	TopF	-10 to +70	°C		
	Rear surface	TopR	TBD	°C		
Relative humidity Note5		RH	≤ 95	%	Ta ≤ 40°C	
			≤ 85	%	40 < Ta ≤ 50°C	
			≤ 70	%	50 < Ta ≤ 55°C	
			≤ 60	%	55 < Ta ≤ 60°C	
			≤ 50	%	60 < Ta ≤ 65°C	
			≤ 42	%	65 < Ta ≤ 70°C	
Absolute humidity Note5		-	≤ 78 Note6	g/m <sup>3</sup>	Ta > 70°C	

Note1: Display signals are CLK, Hsync, Vsync, DE and DATA (R0 to R5, G0 to G5, B0 to B5).

Note2: Function signals are DPSH, DPSV and PNS.

Note3: "VBLH" is the voltage value between low voltage terminal (Cold) and high voltage terminal (Hot).

Note4: "VBLC" is the voltage value between frame ground (FG) and low voltage terminal (Cold).

Note5: No condensation

Note6: Ta = 70°C, RH = 42%



### 4.3 ELECTRICAL CHARACTERISTICS

#### 4.3.1 Driving for LCD panel signal processing board

(Ta = 25°C)

Parameter	Symbol	Min.	Typ.	Max.	Unit	Remarks
Supply voltage	VCC	3.0	3.3	3.6	V	for 3V system
		4.7	5.0	5.3	V	for 5V system
Supply current	ICC	-	180 Note1	250	mA	VCC = 3.3V
		-	120 Note1	165	mA	VCC = 5.0V
Logic input voltage for display signals	Low	VDLL	0	-	0.3Vcc	CMOS level
	High	VDLH	0.7Vcc	-	Vcc	
Input voltage for DPSH or DPSV signals	Low	VFDL	0	-	0.3Vcc	
	High	VFDH	0.7Vcc	-	Vcc	
Input voltage for PNS signal	Low	VFPL	0	-	0.3Vcc	
	High	VFPH	0.7Vcc	-	Vcc	

Note1: Checkered flag pattern [by EIAJ ED-2522]

#### 4.3.2 Working for backlight lamp

Parameter	Symbol	Ta	Min.	Typ.	Max.	Unit	Remarks
Starting voltage	VS	0°C	720	-	-	Vrms	Note1
		25°C	570	-	-	Vrms	
Supply voltage	VBLH	25°C	-	350	-	Vrms	Note1, Note2
Supply current	IBL	25°C	3.0	5.0	5.5	mArms	Note2
Oscillation frequency	FO	25°C	40	45	50	kHz	Note3

Note1: The supply voltage cycle between lamps should be kept on a same phase. Also "VS" and "VBLH" are the voltage value between low voltage side (Cold) and high voltage side (Hot).

Note2: The asymmetric ratio of working waveform for lamps (Supply voltage peak ratio, supply current peak ratio and waveform space ratio) should be less than 5 % (See the following figure.). If the waveform is asymmetric, DC (Direct current) element apply into the lamp. In this case, a lamp lifetime may be shortened, because a distribution of a lamp enclosure substance inclines toward one side between low voltage terminal (Cold terminal) and high voltage terminal (Hot terminal).

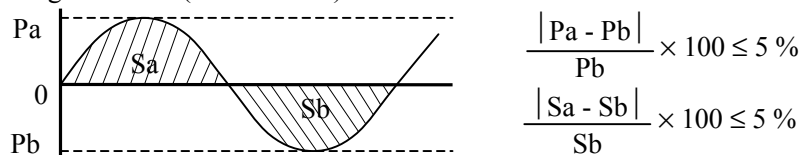

Pa: Supply voltage/current peak for positive, Pb: Supply voltage/current peak for negative

Sa: Waveform space for positive part, Sb: Waveform space for negative part

Note3: In case "FO" is not the recommended value, beat noise may display on the screen, because of interference between "FO" and "1/th". Recommended value of "FO" is as following.

$$FO = \frac{1}{4} \times \frac{1}{th} \times (2n-1)$$

th: Horizontal synchronous cycle (See "4.9.4 Timing characteristics".)

n: Natural number (1, 2, 3 .....)

### 4.3.3 Supply voltage ripple

This product works, even if the ripple voltage levels are beyond the permissible values as following the table, but there might be noise on the display image.

Parameter	Supply voltage	Ripple voltage (Measure at input terminal of power supply)	Note1	Unit
VCC	3.3 V	≤ 100		mVp-p
	5.0 V	≤ TBD		mVp-p

Note1: The permissible ripple voltage includes spike noise.

### 4.3.4 Fuses

3

Fusing line	Fuse		Rating	Unit	Remark
	Type	Supplier			
VCC	ICP-S1.8	ROHM Co., Ltd.	4.0	A	Note1, Note2
			50	V	-

Note1: This current rating is a fusing current.

Note2: The power capacity should be more than the fusing current rating. If the power capacity is less than the criteria value, the fuse may not blow, and then nasty smell, smoking and so on may occur.

4.4 SUPPLY VOLTAGE SEQUENCE

4.4.1 Sequence for LCD panel signal processing board

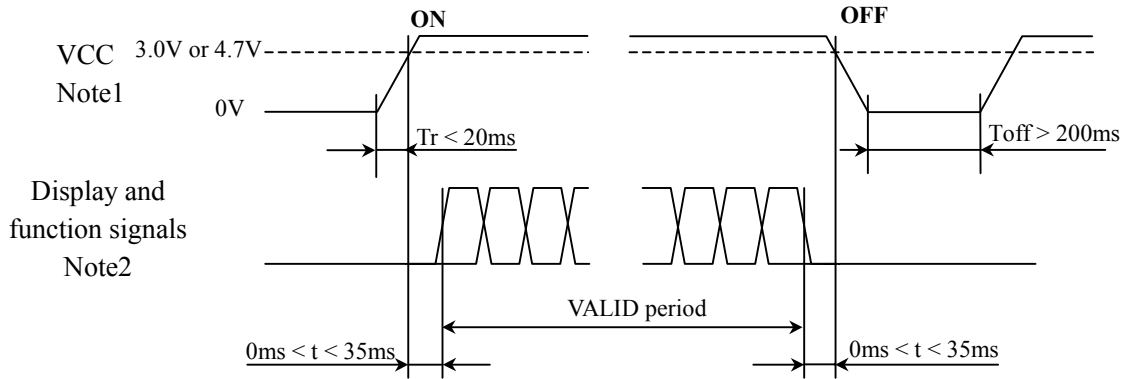

Note1: In terms of voltage variation (voltage drop) while VCC rising edge is below 3.0V in "VCC = 3.3V" or 4.7V in "VCC = 5.0V", a protection circuit may work, and then this product may not work.

Note2: Display (CLK, Hsync, Vsync, DE, R0 to R5, G0 to G5, B0 to B5) and function (DPSH, DPSV, PNS) signals must be Low or High-impedance, exclude the VALID period (See above sequence diagram), in order to avoid that internal circuits is damaged.

If some of display and function signals of this product are cut while this product is working, even if the signal input to it once again, it might not work normally. If customer stops the display and function signals, they should be cut VCC.

4.4.2 Sequence for backlight inverter (Option)

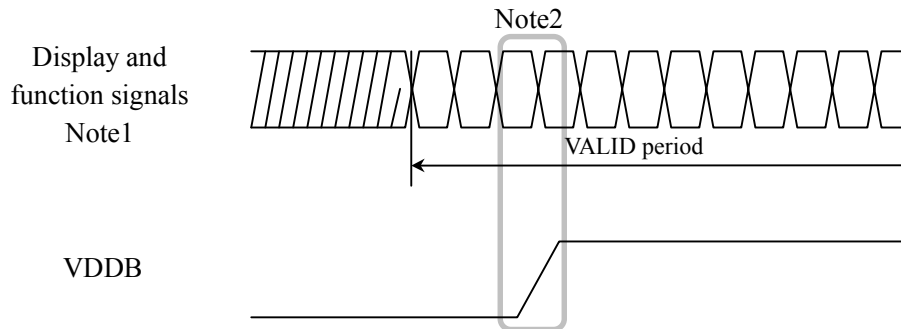

Note1: These are display and function signals for LCD panel signal processing board.

Note2: The backlight inverter voltage (VDDDB) should be inputted within the valid period of display and function signals, in order to avoid unstable data display.

## 4.5 CONNECTIONS AND FUNCTIONS FOR INTERFACE PINS

## 4.5.1 LCD panel signal processing board

CN1 socket (LCD module side): 08-6210-033-340-800 (Kyocera Elco Corp.)

Adaptable plug: Flexible cable

Pin No.	Symbol	Signal	Remarks
1	GND	Ground	-
2	CLK	Dot clock	
3	Hsync	Horizontal synchronous	
4	Vsync	Vertical synchronous	
5	GND	Ground	
6	R0	Red data (LSB)	Least significant bit
7	R1	Red data	-
8	R2	Red data	
9	R3	Red data	
10	R4	Red data	
11	R5	Red data (MSB)	Most significant bit
12	GND	Ground	-
13	G0	Green data (LSB)	Least significant bit
14	G1	Green data	-
15	G2	Green data	
16	G3	Green data	
17	G4	Green data	
18	G5	Green data (MSB)	Most significant bit
19	GND	Ground	-
20	B0	Blue data (LSB)	Least significant bit
21	B1	Blue data	-
22	B2	Blue data	
23	B3	Blue data	
24	B4	Blue data	
25	B5	Blue data (MSB)	Most significant bit
26	GND	Ground	-
27	DE	Select of DE / Fixed mode	DE mode: Data enable signal, Fixed mode: Open
28	VCC	Power supply	-
29	VCC	Power supply	
30	DPSH	Select of scan direction (Horizontal)	Normal scan: Low or Open, Reverse scan: High Note1
31	DPSV	Select of scan direction (Vertical)	
32	PNS	Select of pixel number	QVGA mode: High, VGA mode: Low or Open Note1
33	GND	Ground	-

Note1: See "4.8 SCANNING DIRECTIONS".

CN1: Figure of socket

1 2 3 -----31 32 33

4.5.2 Backlight lamp

CN2 socket: BHR-03VS-1 (J.S.T Mfg. Co., Ltd.)

Adaptable plug: SM03 (4.0) B-BHS-TB (J.S.T Mfg. Co., Ltd.)

Pin No.	Symbol	Signal	Remarks
1	VBLH	High voltage (Hot)	-
2	NC	Non connection	
3	VBLC	Low voltage (Cold)	

CN2: Figure of socket

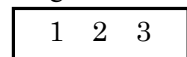

4.5.3 Positions of sockets

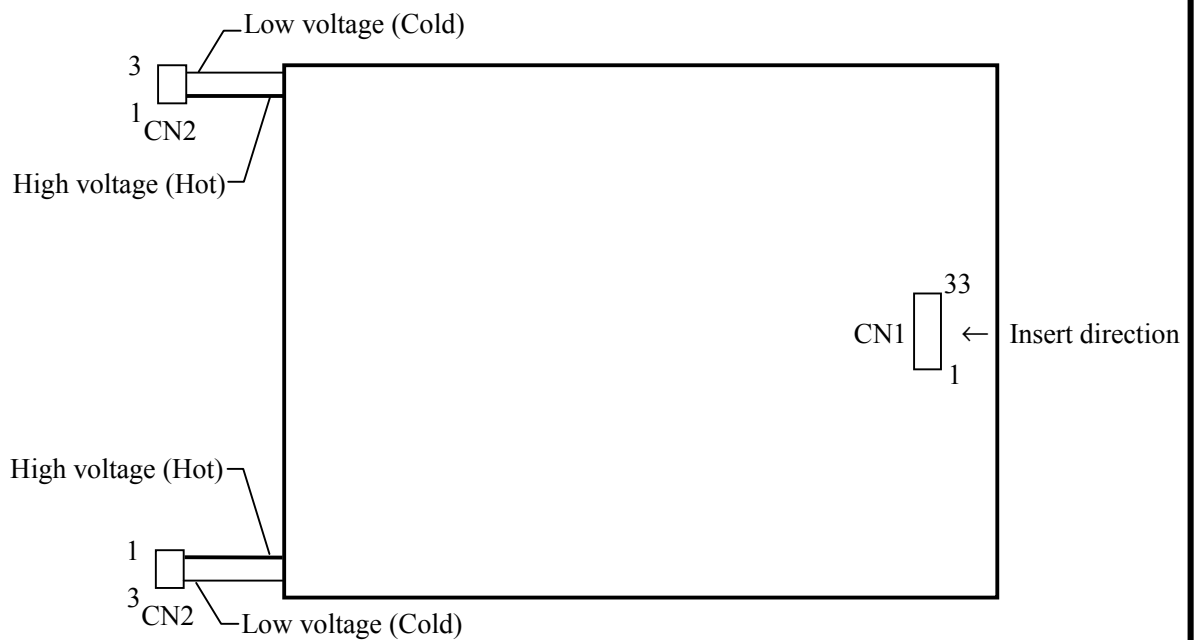

4.6 DISPLAY COLORS AND INPUT DATA SIGNALS

This product can display in equivalent to 262,144 colors in 64 scale. Also the relation between display colors and input data signals is as the following table.

Display colors		Data signal (0: Low level, 1: High level)																	
		R 5	R 4	R 3	R 2	R 1	R 0	G 5	G 4	G 3	G 2	G 1	G 0	B 5	B 4	B 3	B 2	B 1	B 0
Basic colors	Black	0	0	0	0	0	0	0	0	0	0	0	0	0	0	0	0	0	0
	Blue	0	0	0	0	0	0	0	0	0	0	0	0	1	1	1	1	1	1
	Red	1	1	1	1	1	1	0	0	0	0	0	0	0	0	0	0	0	0
	Magenta	1	1	1	1	1	1	0	0	0	0	0	0	1	1	1	1	1	1
	Green	0	0	0	0	0	0	1	1	1	1	1	1	0	0	0	0	0	0
	Cyan	0	0	0	0	0	0	1	1	1	1	1	1	1	1	1	1	1	1
	Yellow	1	1	1	1	1	1	1	1	1	1	1	1	0	0	0	0	0	0
	White	1	1	1	1	1	1	1	1	1	1	1	1	1	1	1	1	1	1
Red scale	Black	0	0	0	0	0	0	0	0	0	0	0	0	0	0	0	0	0	0
		0	0	0	0	0	1	0	0	0	0	0	0	0	0	0	0	0	0
	dark	0	0	0	0	1	0	0	0	0	0	0	0	0	0	0	0	0	0
	↑				:						:					:			
	↓				:						:					:			
bright	1	1	1	1	0	1	0	0	0	0	0	0	0	0	0	0	0	0	
	1	1	1	1	1	0	0	0	0	0	0	0	0	0	0	0	0	0	
Red	1	1	1	1	1	1	0	0	0	0	0	0	0	0	0	0	0	0	
Green scale	Black	0	0	0	0	0	0	0	0	0	0	0	0	0	0	0	0	0	0
		0	0	0	0	0	0	0	0	0	0	1	0	0	0	0	0	0	0
	dark	0	0	0	0	0	0	0	0	0	1	0	0	0	0	0	0	0	0
	↑				:						:					:			
	↓				:						:					:			
bright	0	0	0	0	0	0	1	1	1	1	0	1	0	0	0	0	0	0	
	0	0	0	0	0	0	1	1	1	1	1	0	0	0	0	0	0	0	
Green	0	0	0	0	0	0	1	1	1	1	1	1	0	0	0	0	0	0	
Blue scale	Black	0	0	0	0	0	0	0	0	0	0	0	0	0	0	0	0	0	0
		0	0	0	0	0	0	0	0	0	0	0	0	0	0	0	0	0	1
	dark	0	0	0	0	0	0	0	0	0	0	0	0	0	0	0	0	1	0
	↑				:						:					:			
	↓				:						:					:			
bright	0	0	0	0	0	0	0	0	0	0	0	0	1	1	1	1	0	1	
	0	0	0	0	0	0	0	0	0	0	0	0	1	1	1	1	1	0	
Blue	0	0	0	0	0	0	0	0	0	0	0	0	1	1	1	1	1	1	

### 4.7 DISPLAY POSITIONS

The following table is the coordinates per pixel (See figure of "4.8 SCANNING DIRECTIONS").

C( 0, 0)	C( 1, 0)	...	C( X, 0)	...	C(318, 0)	C(319, 0)
C( 0, 1)	C( 1, 1)	...	C( X, 1)	...	C(318, 1)	C(319, 1)
⋮	⋮	⋮	⋮	⋮	⋮	⋮
C( 0, Y)	C( 1, Y)	...	C( X, Y)	...	C(318, Y)	C(319, Y)
⋮	⋮	⋮	⋮	⋮	⋮	⋮
C( 0,238)	C( 1,238)	...	C( X,238)	...	C(318,238)	C(319,238)
C( 0,239)	C( 1,239)	...	C( X,239)	...	C(318,239)	C(319,239)

### 4.8 SCANNING DIRECTIONS

#### 4.8.1 QVGA display mode

The following figures are seen from a front view. Also the arrow shows the direction of scan.

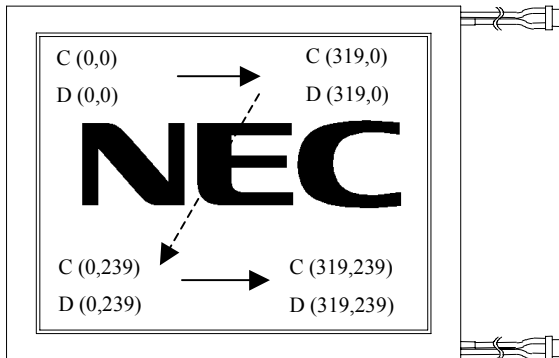

Figure 1. DPSH: Normal scan, DPSV: Normal scan

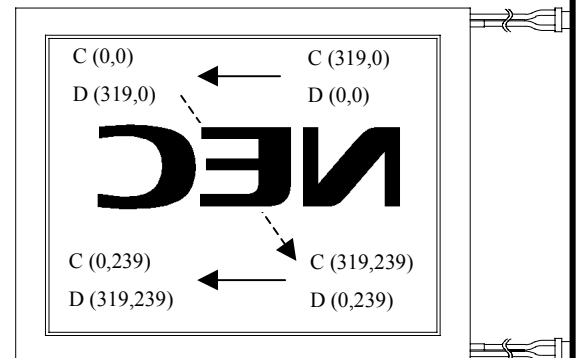

Figure 2. DPSH: Reverse scan, DPSV: Normal scan

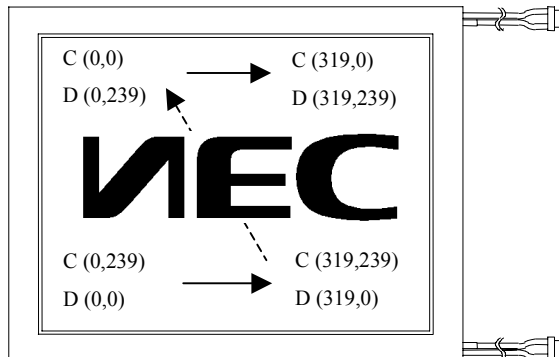

Figure 3. DPSH: Normal scan, DPSV: Reverse scan

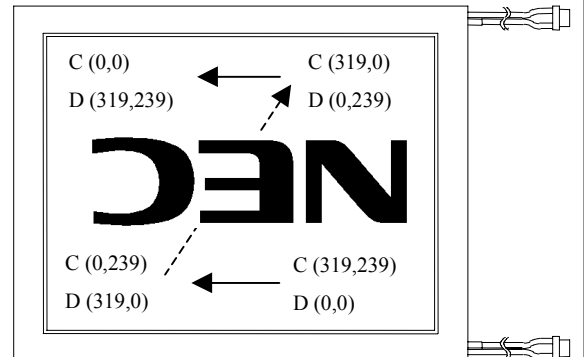

Figure 4. DPSH: Reverse scan, DPSV: Reverse scan

Note1: Meaning of C (X, Y) and D (X, Y)

C (X, Y): The coordinates of the display position (See "4.7 DISPLAY POSITIONS".)

D (X, Y): The data number of QVGA input signal for LCD panel signal processing board

Note2: Normal scan: Low or Open, Reverse scan: High

4.8.2 VGA display mode

The following figures are seen from a front view. Also the arrow shows the direction of scan, and a dotted line is a virtual display domain. In this display mode, only quarter domains of virtual display are displayed on the screen.

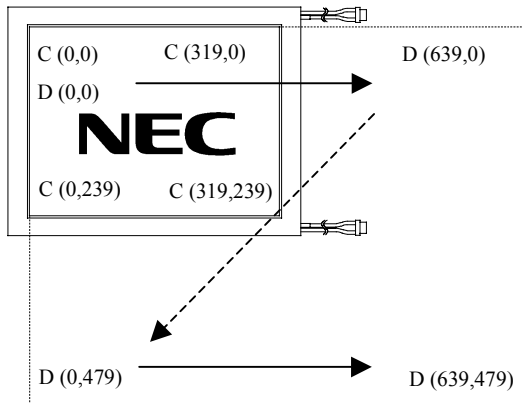

Figure 1. DPSH: Normal scan, DPSV: Normal scan

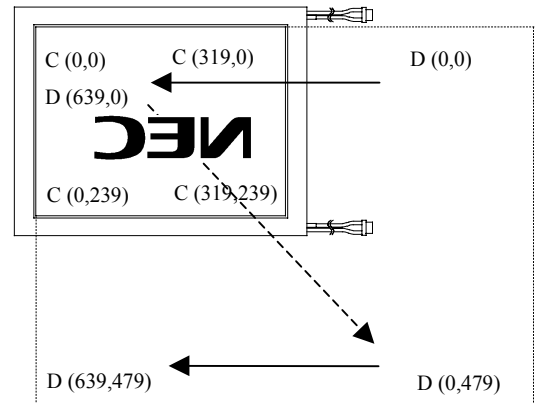

Figure 2. DPSH: Reverse scan, DPSV: Normal scan

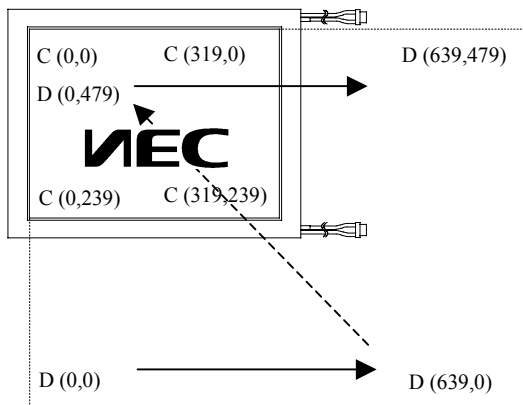

Figure 3. DPSH: Normal scan, DPSV: Reverse scan

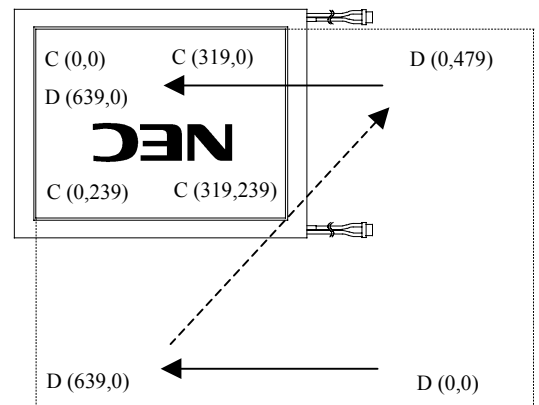

Figure 4. DPSH: Reverse scan, DPSV: Reverse scan

Note1: Meaning of C (X, Y) and D (X, Y)

C (X, Y): The coordinates of the display position (See "4.7 DISPLAY POSITIONS".)

D (X, Y): The data number of VGA input signal for LCD panel signal processing board

Note2: Normal scan: Low or Open, Reverse scan: High



## 4.9 INPUT SIGNAL TIMINGS FOR LCD PANEL SIGNAL PROCESSING BOARD

### 4.9.1 Outline of QVGA input signal timings

- Horizontal signal

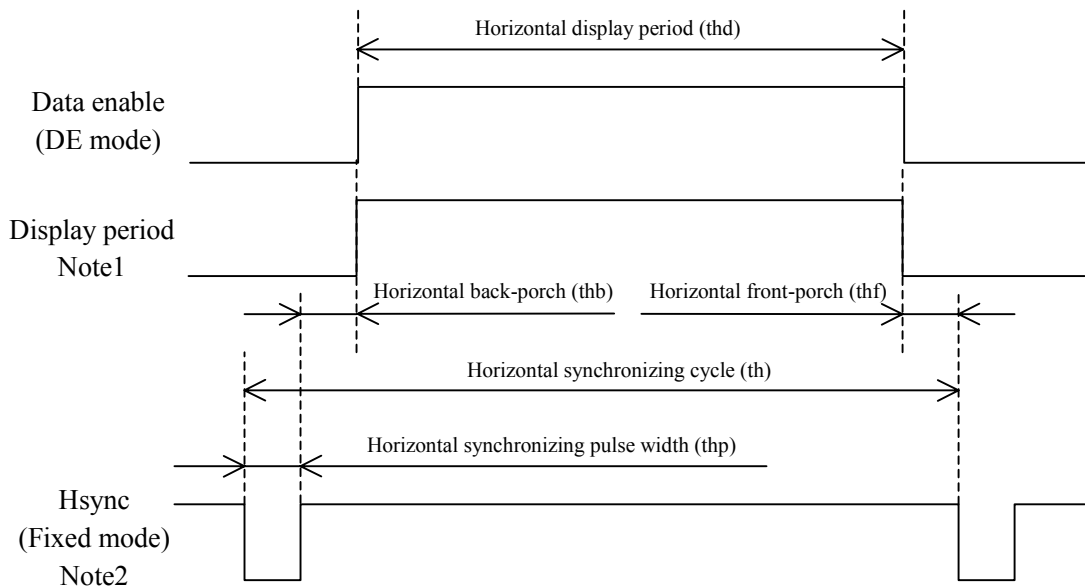

Note1: This diagram indicates virtual signal for set up to timing.

- Vertical signal

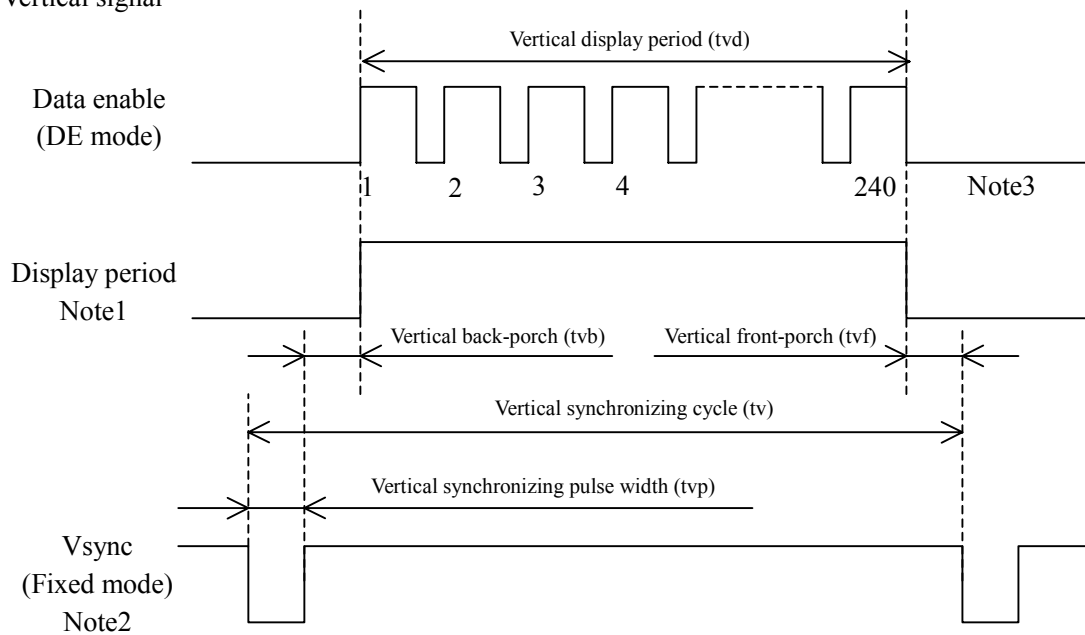

Note1: This diagram indicates virtual signal for set up to timing.

Note2: Fixed mode cannot be used while working of DE mode.

Note3: See "4.9.3 Detailed QVGA input signal timing chart for DE mode" and "4.9.4 Detailed QVGA input signal timing chart for fixed mode" for numeration of pulse.

4.9.2 Outline of VGA input signal timings

• Horizontal signal

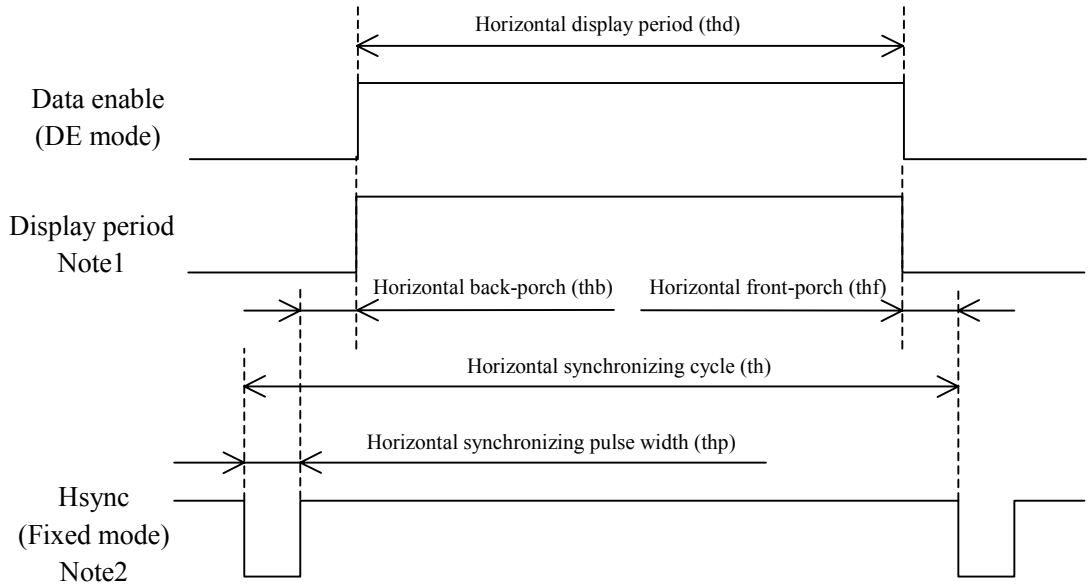

Note1: This diagram indicates virtual signal for set up to timing.

• Vertical signal

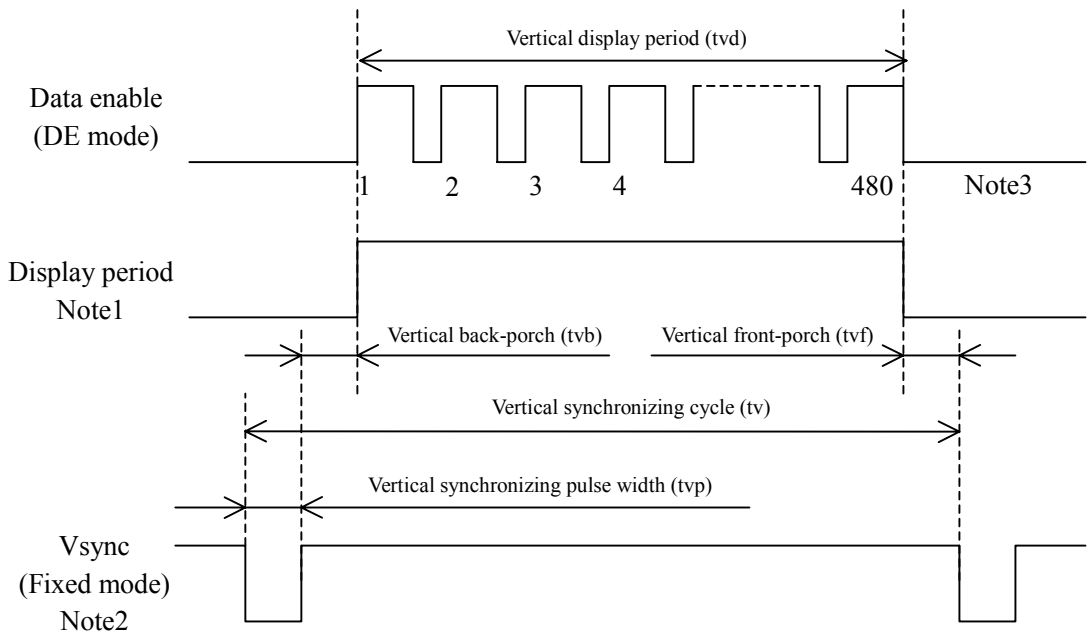

Note1: This diagram indicates virtual signal for set up to timing.

Note2: Fixed mode cannot be used while working of DE mode.

Note3: See "4.9.5 Detailed VGA input signal timing chart for DE mode" and "4.9.6 Detailed VGA input signal timing chart for fixed mode" for numeration of pulse.

4.9.3 Detailed QVGA input signal timing chart for DE mode

- Outline chart

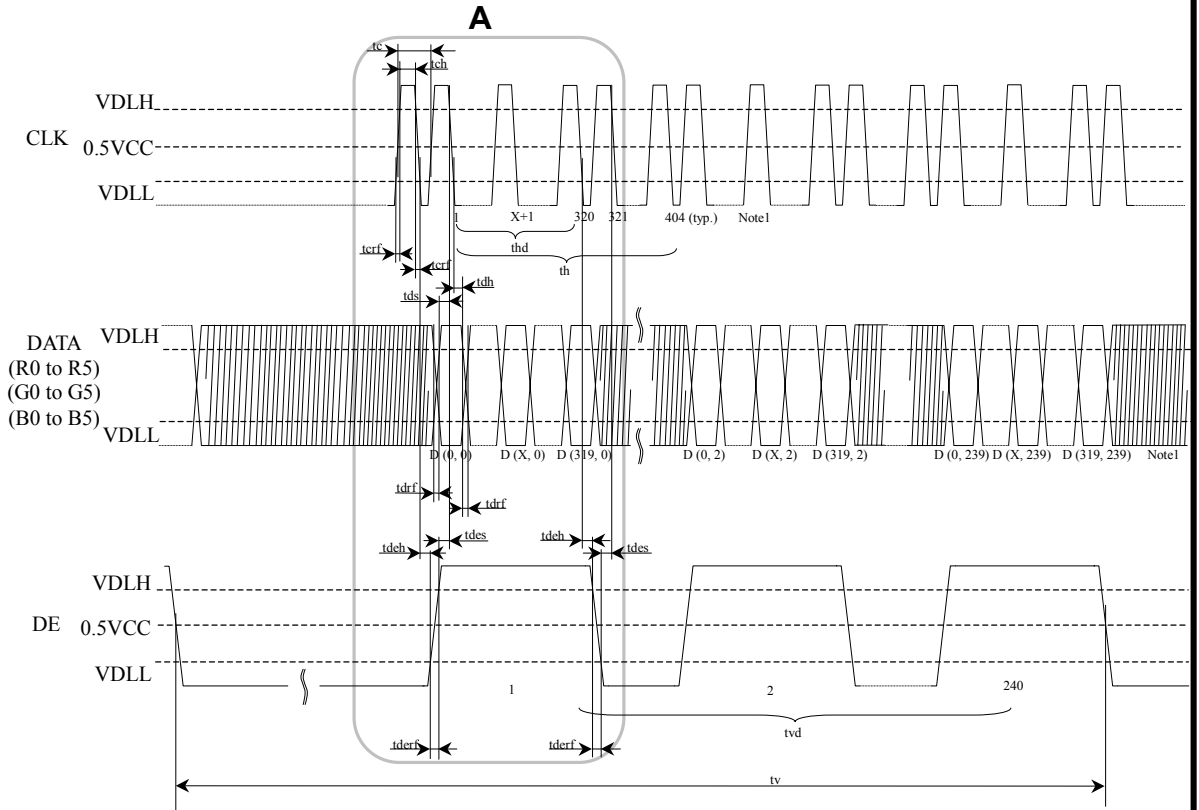

Note1: X is data number from 1 to 318. See "4.8.1 QVGA display mode".

- Detail of A part

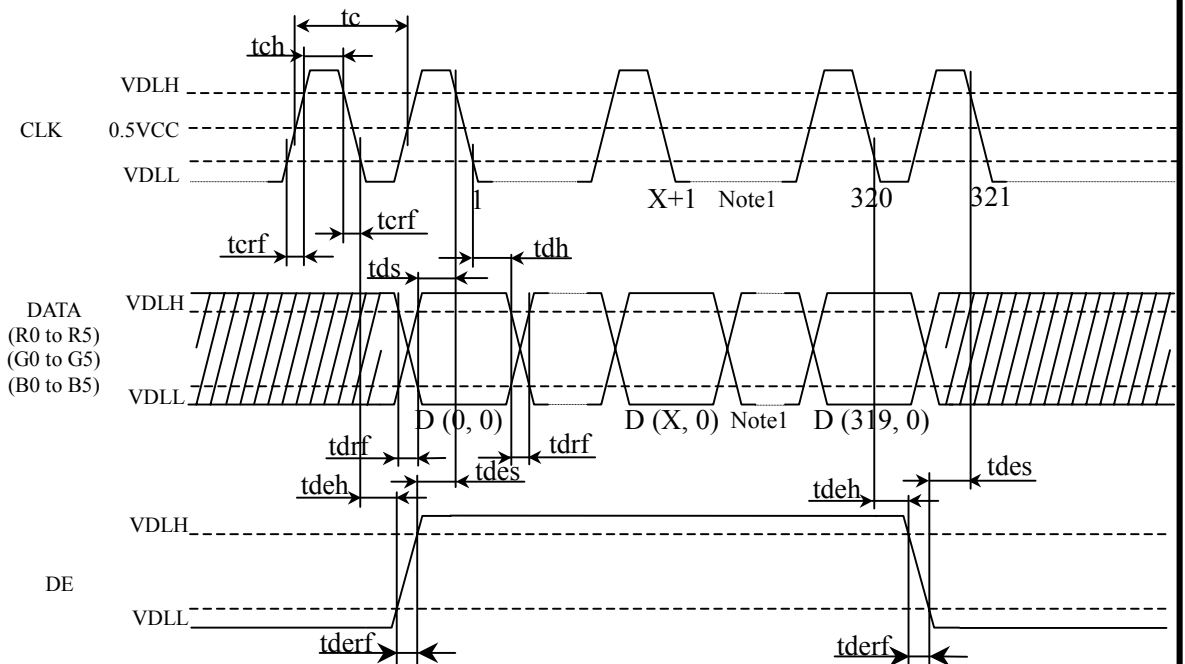

Note1: X is data number from 1 to 318. See "4.8.1 QVGA display mode".

4.9.4 Detailed QVGA input signal timing chart for fixed mode

• Outline chart

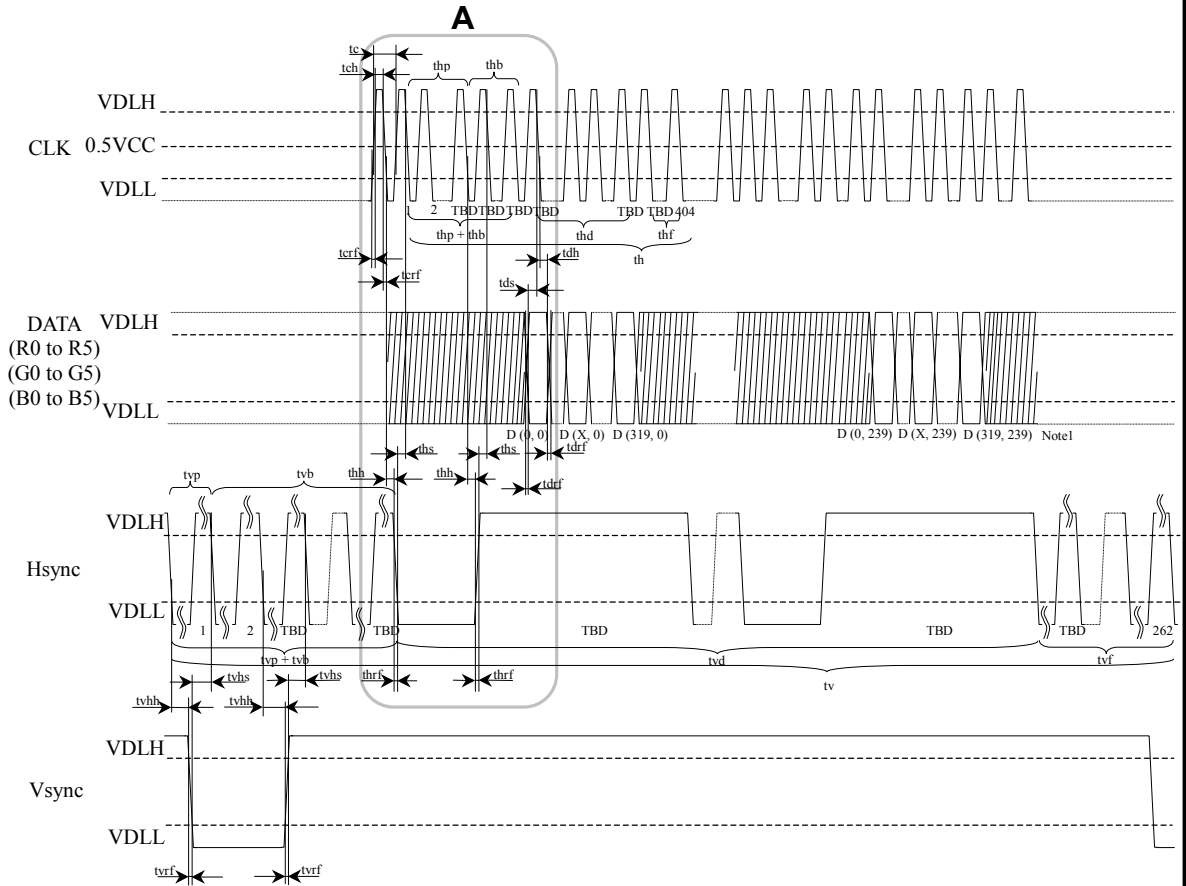

Note1: X is data number from 1 to 318. See "4.8.1 QVGA display mode".

• Detail of A part

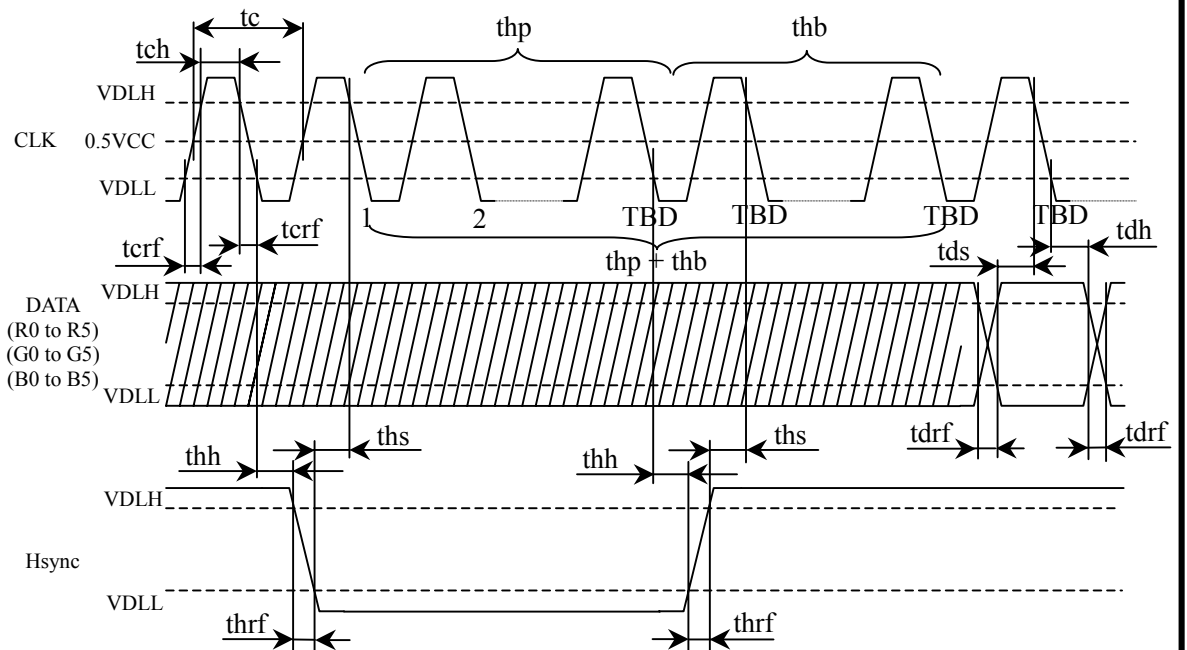

### 4.9.5 Detailed VGA input signal timing chart for DE mode

• Outline chart

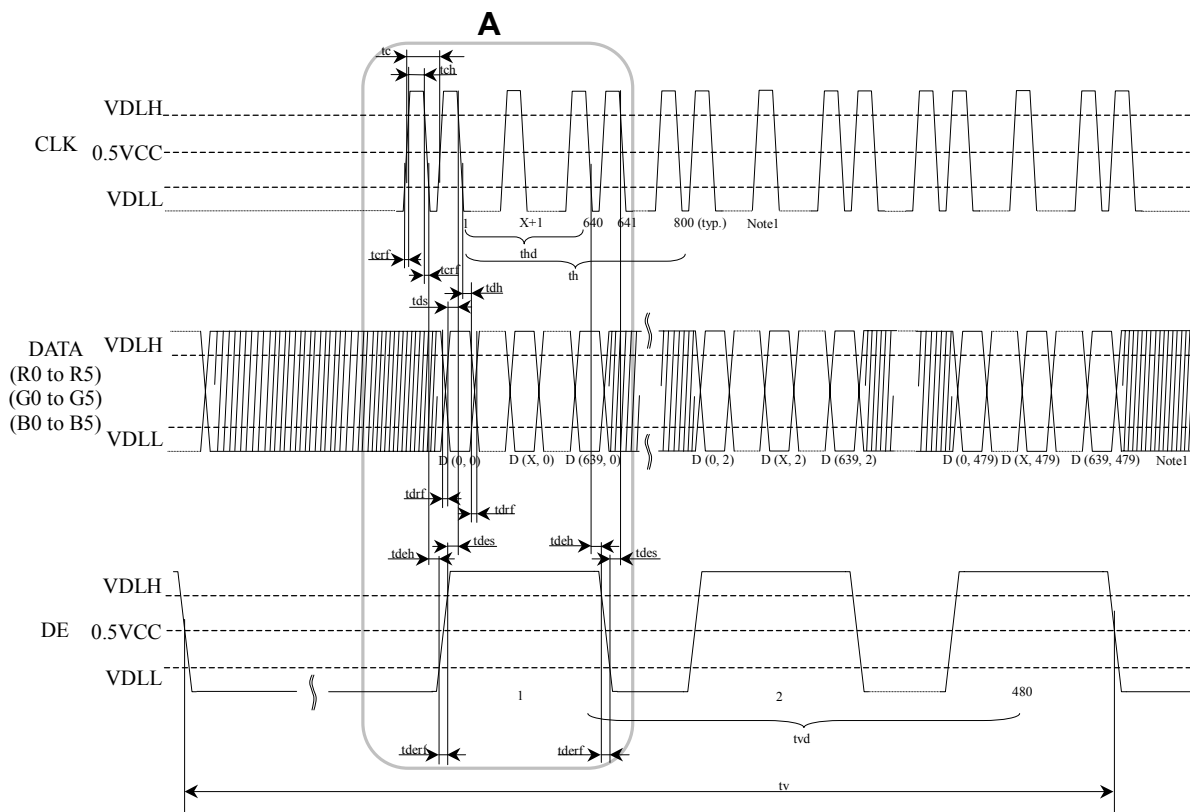

Note1: X is data number from 1 to 638. See "4.8.2 VGA display mode".

• Detail of A part

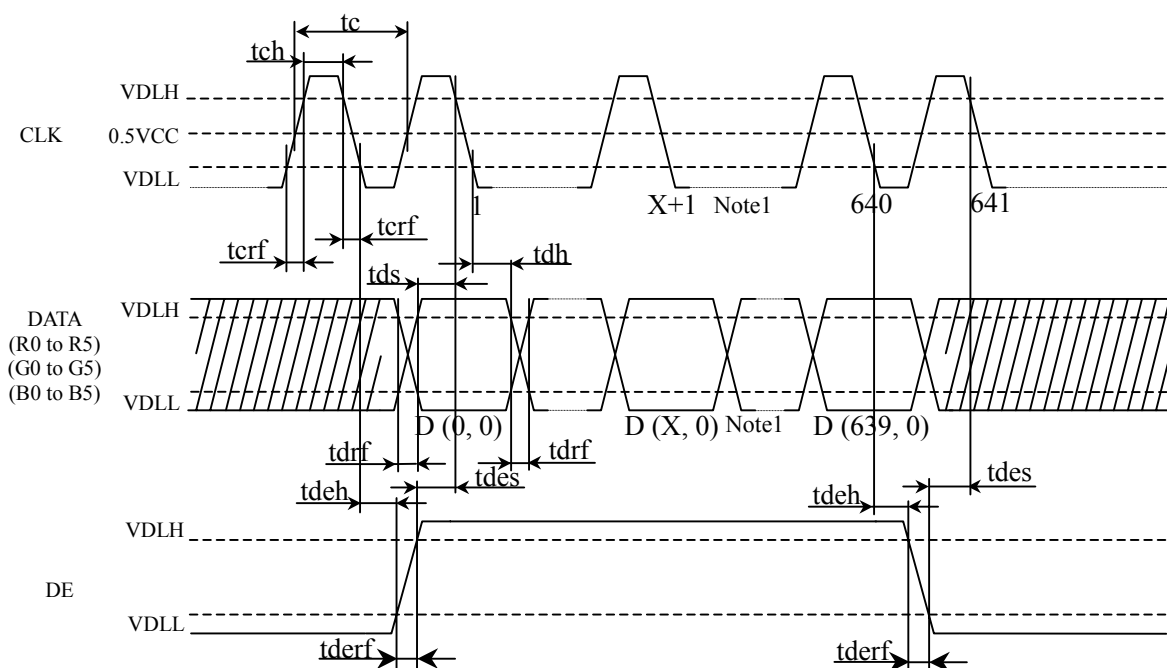

Note1: X is data number from 1 to 638. See "4.8.2 VGA display mode".

4.9.6 Detailed VGA input signal timing chart for fixed mode

• Outline chart

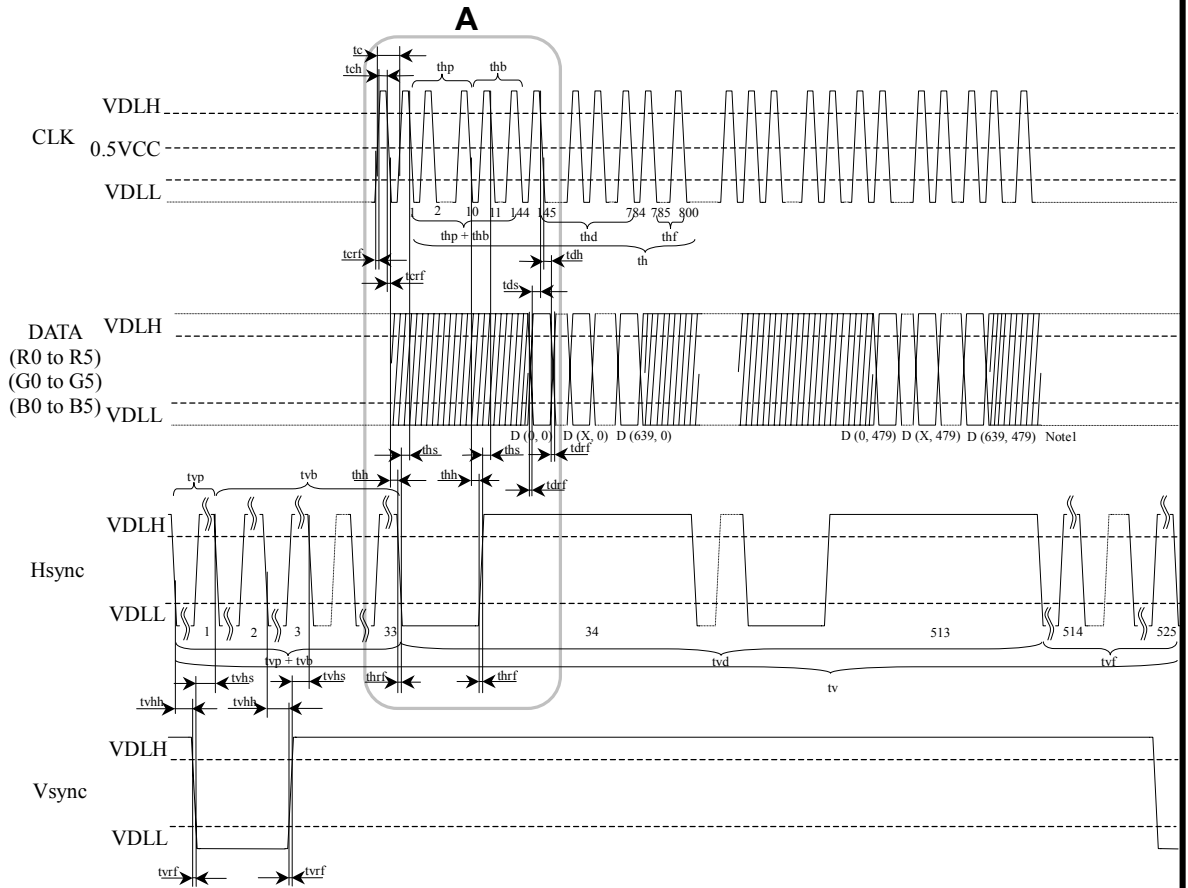

Note1: X is data number from 1 to 638. See "4.8.2 VGA display mode".

• Detail of A part

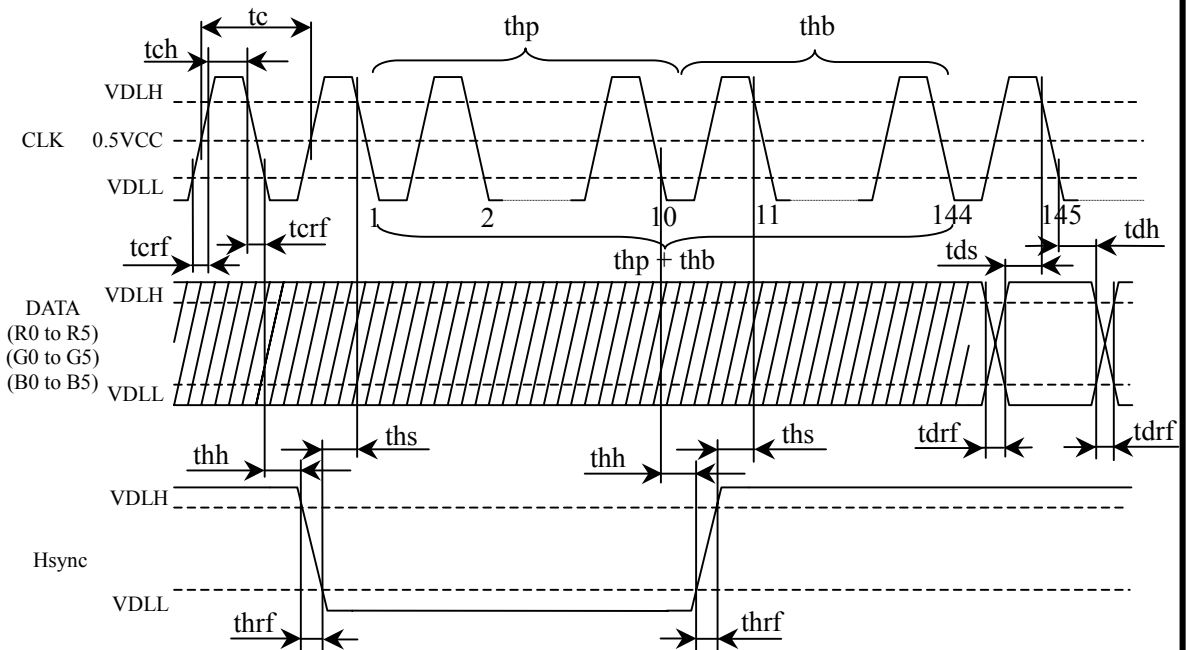

## 4.9.7 Timing characteristics for QVGA display mode

## • Common to DE mode and fixed mode

Parameter		Symbol	Min.	Typ.	Max.	Unit	Remarks
CLK	Frequency	tcf	TBD	6.4	7.0	MHz	157.5 ns (typ.) Note1
	Duty	tcd	0.4	-	0.6	-	Note1
	Rise time, Fall time	tcrf	-	-	10	ns	-
DATA	CLK-DATA	Setup time	2	-	-	ns	
		Hold time	3	-	-	ns	
Rise time, Fall time		tdrf	-	-	10	ns	

Note1: Definition of units is as follows.

$$tcf = 1/tc, tcd = tch/tc = tch \times tcd$$

## • DE mode

Parameter		Symbol	Min.	Typ.	Max.	Unit	Remarks	
DE	Horizontal	Cycle	th	TBD	404	-	CLK	Note1
		Display period	thd	320			CLK	
	Vertical (One frame)	Cycle	tv	TBD	262	-	H	
		Display period	tvd	240			H	
	CLK-DE	Setup time	tdes	2	-	-	ns	-
		Hold time	tdeh	3	-	-	ns	
Rise time, Fall time		tderf	-	-	10	ns		

Note1: Definition of units is as follows.

$$tc = 1CLK, th = 1H$$

## • Fixed mode

Parameter		Symbol	Min.	Typ.	Max.	Unit	Remarks	
Hsync	Cycle	th	50.0	63.6	TBD	$\mu$ s	31.4 kHz (typ.)	
			404			CLK	Note1	
	Display period	thd	320			CLK		
	Front-porch	thf	TBD			CLK		
	Pulse width	thp	TBD	TBD	-	CLK		
	Back-porch	thb	-	TBD	TBD	CLK		
	Total of pulse width and back-porch		thp + thb	TBD			CLK	Note1, Note2
	CLK- Hsync	Setup time	ths	2	-	-	ns	-
Hold time		thh	3	-	-	ns		
Rise time, Fall time		thrf	-	-	10	ns		
Vsync	Cycle	tv	TBD	16.7	17.2	ms	59.9 Hz (typ.)	
			525			H	Note1	
	Display period	tvd	480			H		
	Front-porch	tvf	1			H		
	Pulse width	tvp	1	-	TBD	H		
	Back-porch	tvb	TBD	-	TBD	H		
	Total of pulse width and back-porch		tvp + tvb	TBD			H	Note1, Note2
	Vsync-Hsync	Setup time	tvhs	2	-	-	ns	Note1
Hold time		tvhh	3	-	-	CLK		
Rise time, Fall time		tvrf	-	-	10	ns	-	

Note1: Definition of units is as follows.

$$tc = 1CLK, th = 1H$$

Note2: Keep tvp + tvb and thp + thb within the table. If it is out of specification, display position will be shifted to right/left side or up/down.

## 4.9.8 Timing characteristics for VGA display mode

## • Common to DE mode and fixed mode

Parameter		Symbol	Min.	Typ.	Max.	Unit	Remarks	
CLK	Frequency	tcf	21.0	25.2	29.0	MHz	39.7 ns (typ.) Note1	
	Duty	tcd	0.5	-	0.6	-	Note1	
	Rise time, Fall time	tcrf	-	-	10	ns	-	
DATA	CLK-DATA	Setup time	tds	8	-	-		ns
		Hold time	tdh	12	-	-		ns
Rise time, Fall time		tdrf	-	-	10	ns		

Note1: Definition of units is as follows.

$$tcf = 1/tc, tcd = tch/tc = tch \times tcd$$

## • DE mode

Parameter		Symbol	Min.	Typ.	Max.	Unit	Remarks	
DE	Horizontal	Cycle	th	-	800	-	CLK	Note1
		Display period	thd	640			CLK	
	Vertical (One frame)	Cycle	tv	-	525	-	H	
		Display period	tvd	480			H	
	CLK-DE	Setup time	tdes	8	-	-	ns	-
		Hold time	tdeh	12	-	-	ns	
Rise time, Fall time		tderf	-	-	10	ns		

Note1: Definition of units is as follows.

$$tc = 1CLK, th = 1H$$

## • Fixed mode

Parameter		Symbol	Min.	Typ.	Max.	Unit	Remarks
Hsync	Cycle	th	30.0	31.8	33.6	$\mu$ s	31.4 kHz (typ.)
			800			CLK	Note1
	Display period	thd	640			CLK	
	Front-porch	thf	16			CLK	
	Pulse width	thp	10	96	-	CLK	
	Back-porch	thb	-	48	134	CLK	
	Total of pulse width and back-porch	thp + thb	144			CLK	
	CLK- Hsync	Setup time	ths	8	-	-	ns
Hold time		thh	12	-	-	ns	
Rise time, Fall time		thrf	-	-	10	ns	
Vsync	Cycle	tv	16.1	16.7	17.2	ms	59.9 Hz (typ.)
			525			H	Note1
	Display period	tvd	480			H	
	Front-porch	tvf	12			H	
	Pulse width	tvp	1	-	2	H	
	Back-porch	tvb	31	-	32	H	
	Total of pulse width and back-porch	tvp + tvb	33			H	
	Vsync-Hsync	Setup time	tvhs	1	-	-	CLK
Hold time		tvhh	30	-	-	ns	-
Rise time, Fall time		tvrf	-	-	10	ns	

Note1: Definition of units is as follows.

$$tc = 1CLK, th = 1H$$

Note2: Keep tvp + tvb and thp + thb within the table. If it is out of specification, display position will be shifted to right/left side or up/down.



## 4.10 OPTICS

## 4.10.1 Optical characteristics

The following characteristics are only applied to QVGA display mode.

Parameter	Note1	Condition	Symbol	Min.	Typ.	Max.	Unit	Remarks	
Contrast ratio		White/Black at center $\theta_R = 0^\circ, \theta_L = 0^\circ, \theta_U = 0^\circ, \theta_D = 0^\circ$	CR	320	400	-	-	Note2	
Luminance		White at center $\theta_R = 0^\circ, \theta_L = 0^\circ, \theta_U = 0^\circ, \theta_D = 0^\circ$	L	240	300	-	cd/m <sup>2</sup>	-	
Luminance uniformity		-	LU	-	1.25	1.40	-	Note3	
Chromaticity	White	x coordinate	Wx	-	0.305	-	-	Note4	
		y coordinate	Wy	-	0.330	-	-		
	Red	x coordinate	Rx	-	TBD	-	-		
		y coordinate	Ry	-	TBD	-	-		
	Green	x coordinate	Gx	-	TBD	-	-		
		y coordinate	Gy	-	TBD	-	-		
	Blue	x coordinate	Bx	-	TBD	-	-		
		y coordinate	By	-	TBD	-	-		
Color gamut		$\theta_R = 0^\circ, \theta_L = 0^\circ, \theta_U = 0^\circ, \theta_D = 0^\circ$ at center, against NTSC color space	C	-	50	-	%		
Response time		White to Black	Ton	-	3	15	ms	Note5	
		Black to White	Toff	-	10	30	ms	Note6	
Viewing angle	CR = 10	Right	$\theta_U = 0^\circ, \theta_D = 0^\circ$	$\theta_R$	-	65	-	$^\circ$	Note7
		Left	$\theta_U = 0^\circ, \theta_D = 0^\circ$	$\theta_L$	-	65	-	$^\circ$	
		Up	$\theta_R = 0^\circ, \theta_L = 0^\circ$	$\theta_U$	-	40	-	$^\circ$	
		Down	$\theta_R = 0^\circ, \theta_L = 0^\circ$	$\theta_D$	-	65	-	$^\circ$	

Note1: Measurement conditions are as follows.

Ta = 25°C, VCC = 3.3V, IBL = 5.0mA, DPSH: Low, DPSV: Low

Optical characteristics are measured at luminance saturation after 20 minutes from working the product, in the dark room. Also measurement method for luminance is as follows.

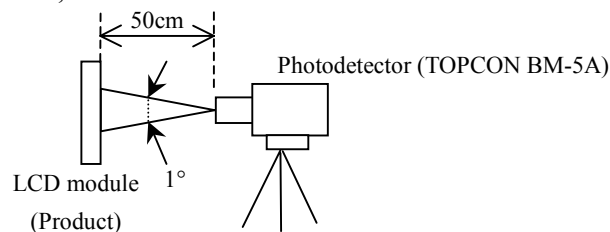

Note2: See "4.10.2 Definition of contrast ratio".

Note3: See "4.10.3 Definition of luminance uniformity".

Note4: These coordinates are found on CIE 1931 chromaticity diagram.

Note5: Product surface temperature: TopF = 25°C

Note6: See "4.10.4 Definition of response times".

Note7: See "4.10.5 Definition of viewing angles".

4.10.2 Definition of contrast ratio

The contrast ratio is calculated by using the following formula.

$$\text{Contrast ratio (CR)} = \frac{\text{Luminance of white screen}}{\text{Luminance of black screen}}$$

4.10.3 Definition of luminance uniformity

The luminance uniformity is calculated by using following formula.

$$\text{Luminance uniformity (LU)} = \frac{\text{Maximum luminance from ① to ⑤}}{\text{Minimum luminance from ① to ⑤}}$$

The luminance is measured at near the 5 points shown below.

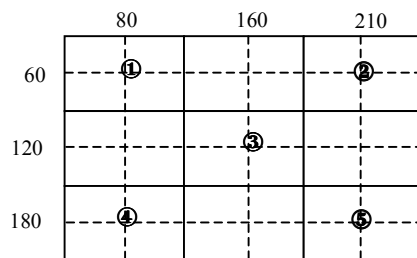

4.10.4 Definition of response times

Response time is measured, the luminance changes from "white" to "black", or "black" to "white" on the same screen point, by photo-detector. Ton is the time it takes the luminance change from 90% down to 10%. Also Toff is the time it takes the luminance change from 10% up to 90% (See the following diagram.).

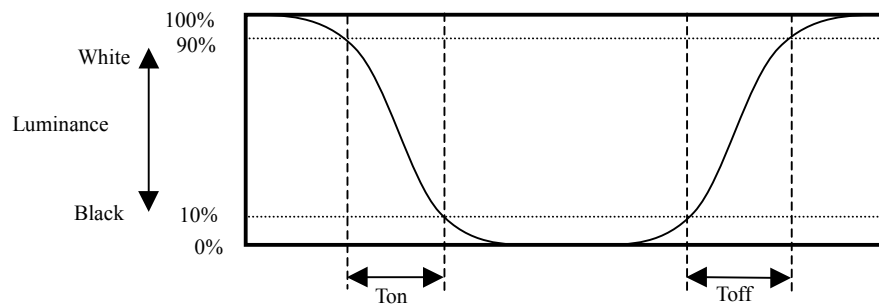

4.10.5 Definition of viewing angles

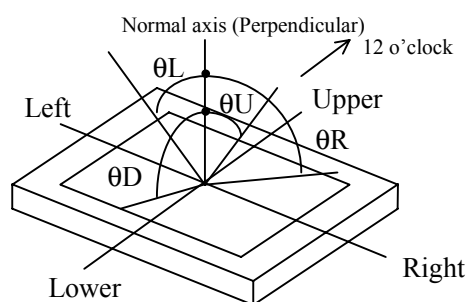

## 5. RELIABILITY TESTS

The result for reliability tests is only applied to QVGA display mode.

Test item	Condition	Judgement
High temperature and humidity (Operation)	① $70 \pm 2^{\circ}\text{C}$ , RH = 42%, 240hours ② Display data is black.	No display malfunctions Note1
High temperature (Operation)	① $70 \pm 2^{\circ}\text{C}$ , 240hours ② Display data is black.	
Heat cycle (Operation)	① $-10 \pm 3^{\circ}\text{C}$ ...1hour $70 \pm 3^{\circ}\text{C}$ ...1hour ② 50cycles, 4hours/cycle ③ Display data is black.	
Thermal shock (Non operation)	① $-30 \pm 3^{\circ}\text{C}$ ...30minutes $80 \pm 3^{\circ}\text{C}$ ...30minutes ② 100cycles, 1hour/cycle ③ Temperature transition time is within 5 minutes.	
ESD (Operation)	① 150pF, 150 $\Omega$ , $\pm 10\text{kV}$ ② 9 places on a panel surface Note2 ③ 10 times each places at 1 sec interval	
Dust (Operation)	① 15 kinds of dust (by JIS-Z8901) ② 15 seconds stir ③ 8 times repeat at 1 hour interval	
Vibration (Non operation)	① 5 to 200Hz, 29.4m/s <sup>2</sup> ② 10 minute/cycle ③ X, Y direction...2hours ④ Z direction...4hours	No display malfunctions Note1 No physical damages
Mechanical shock (Non operation)	① 980m/s <sup>2</sup> , 11ms ② $\pm X$ , $\pm Y$ , $\pm Z$ direction ③ 3 times each directions	

Note1: Display functions are checked under the same conditions as product inspection.

Note2: See the following figure for discharge points.

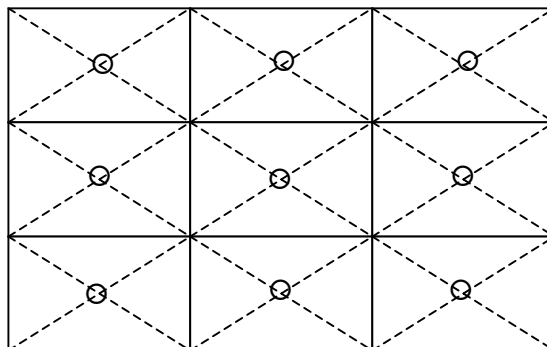

## 6. PRECAUTIONS

### 6.1 MEANING OF CAUTION SIGNS

The following caution signs have very important meaning. **Be sure to read "6.2 CAUTIONS", after understanding this contents!**



This sign has the meaning that customer will be injured by himself, if customer has wrong operations.

### 6.2 CAUTIONS



- \* Pay attention to burn injury for the working backlight! It may be over 35°C from ambient temperature.
- \* Do not shock and press the LCD panel and the backlight! Danger of breaking, because they are made of glass. (Shock: To be not greater 980m/s<sup>2</sup> and to be not greater 11ms, Pressure: To be not greater 19.6N)

### 6.3 ATTENTIONS

#### 6.3.1 Handling of the product

- ① Take hold of both ends without touch the circuit board when customer pulls out products (LCD modules) from inner packing box. If customer touches it, products may be broken down or out of adjustment, because of stress to mounting parts.
- ② Do not hook cables nor pull connection cables such as flexible cable and so on, for fear of damage.
- ③ If customer puts down the product temporarily, the product puts on flat subsoil as a display side turns down.
- ④ Take the measures of electrostatic discharge such as earth band, ionic shower and so on, when customer deals with the product, because products may be damaged by electrostatic.
- ⑤ The torque for mounting screws must never exceed 0.29N·m. Higher torque values might result in distortion of the bezel.
- ⑥ Do not press or rub on the sensitive display surface. If customer clean on the panel surface, NEC Corporation recommends using the cloth with ethanolic liquid such as screen cleaner for LCD.
- ⑦ Do not push-pull the interface connectors while the product is working, because wrong power sequence may break down the product.

#### 6.3.2 Environment

- ① Do not operate in dewdrop atmosphere and corrosive gases.
- ② Do not operate or store in high temperature or high humidity atmosphere. Keep the product in antistatic pouch in room temperature, because of avoidance for dusts and sunlight, if customer stores the product.
- ③ Do not operate in high magnetic field. Circuit boards may be broken down by it.
- ④ Use an original protection sheet on the product surface (polarizer). Adhesive type protection sheet should be avoided, because it may change color or properties of the polarizer.

### 6.3.3 Characteristics

**The following items are neither defects nor failures.**

- ① Response time, luminance and color may be changed by ambient temperature.
- ② The LCD may be seemed luminance non-uniformity, flicker, vertical seam or small spot by display patterns.
- ③ Optical characteristics (e.g. luminance, display uniformity, etc.) gradually is going to change depending on operating time, and especially low temperature, because the LCD has cold cathode fluorescent lamps.
- ④ Do not display the fixed pattern for a long time because it may cause image sticking. Use a screen saver, if the fixed pattern is displayed on the screen.
- ⑤ The display color may be changed by viewing angle because of the use of condenser sheet in the backlight unit.
- ⑥ Optical characteristics may be changed by input signal timings.

### 6.3.4 Other

- ① All GND, backlight inverter ground (GNDB), VCC and backlight inverter supply voltage (VDDDB) terminals should be used without a non-connected line.
- ② Do not disassemble a product or adjust volume without permission of NEC Corporation.
- ③ See "REPLACEMENT MANUAL FOR LAMPHOLDER", if customer would like to replace backlight lamps.
- ④ Pay attention not to insert waste materials inside of products, if customer uses screwnails.
- ⑤ Pack the product with original shipping package, because of avoidance of some damages during transportation, when customer returns it to NEC Corporation for repair and so on.

7. OUTLINE DRAWINGS

7.1 FRONT VIEW

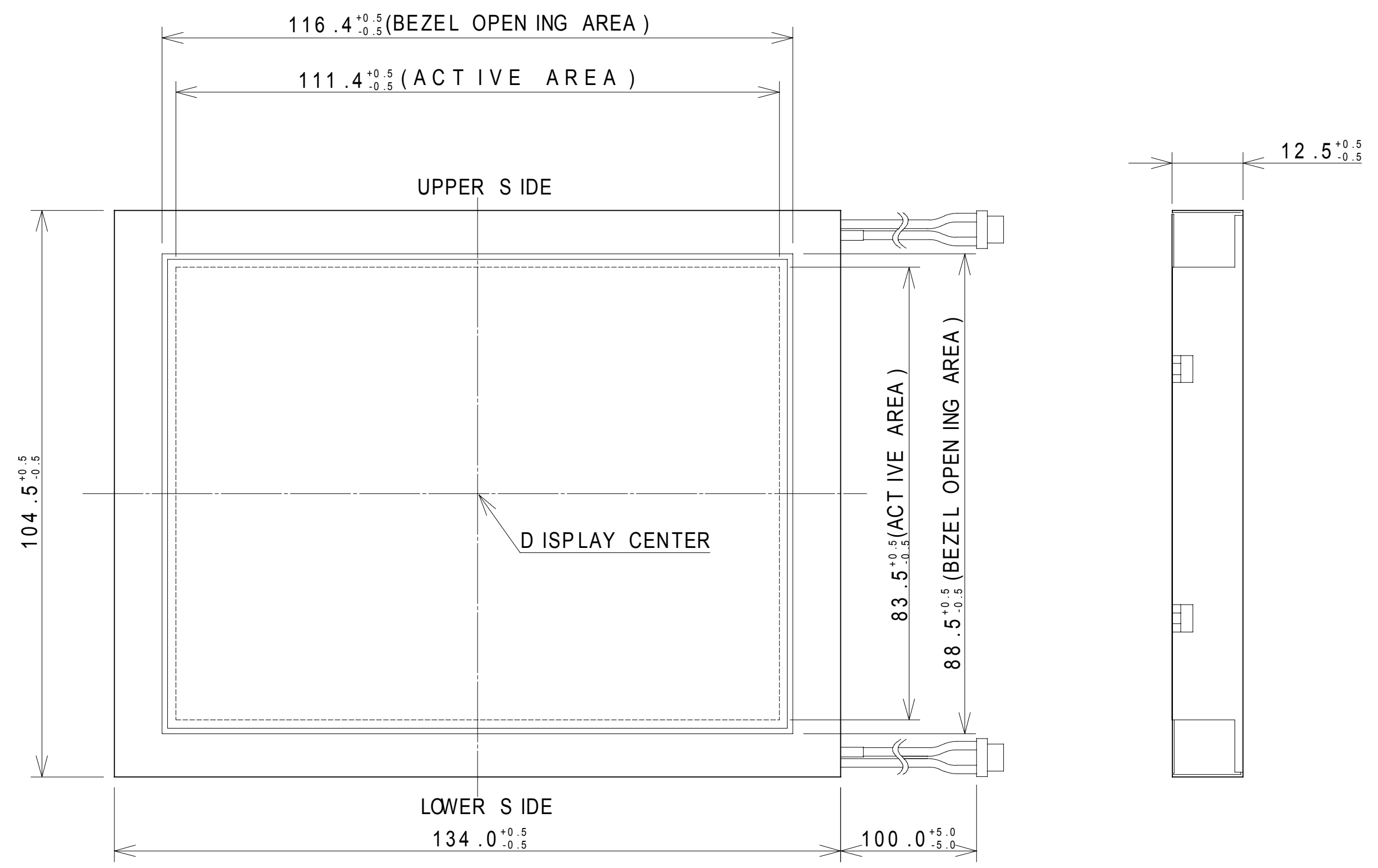

Unit: mm

7.2 REAR VIEW

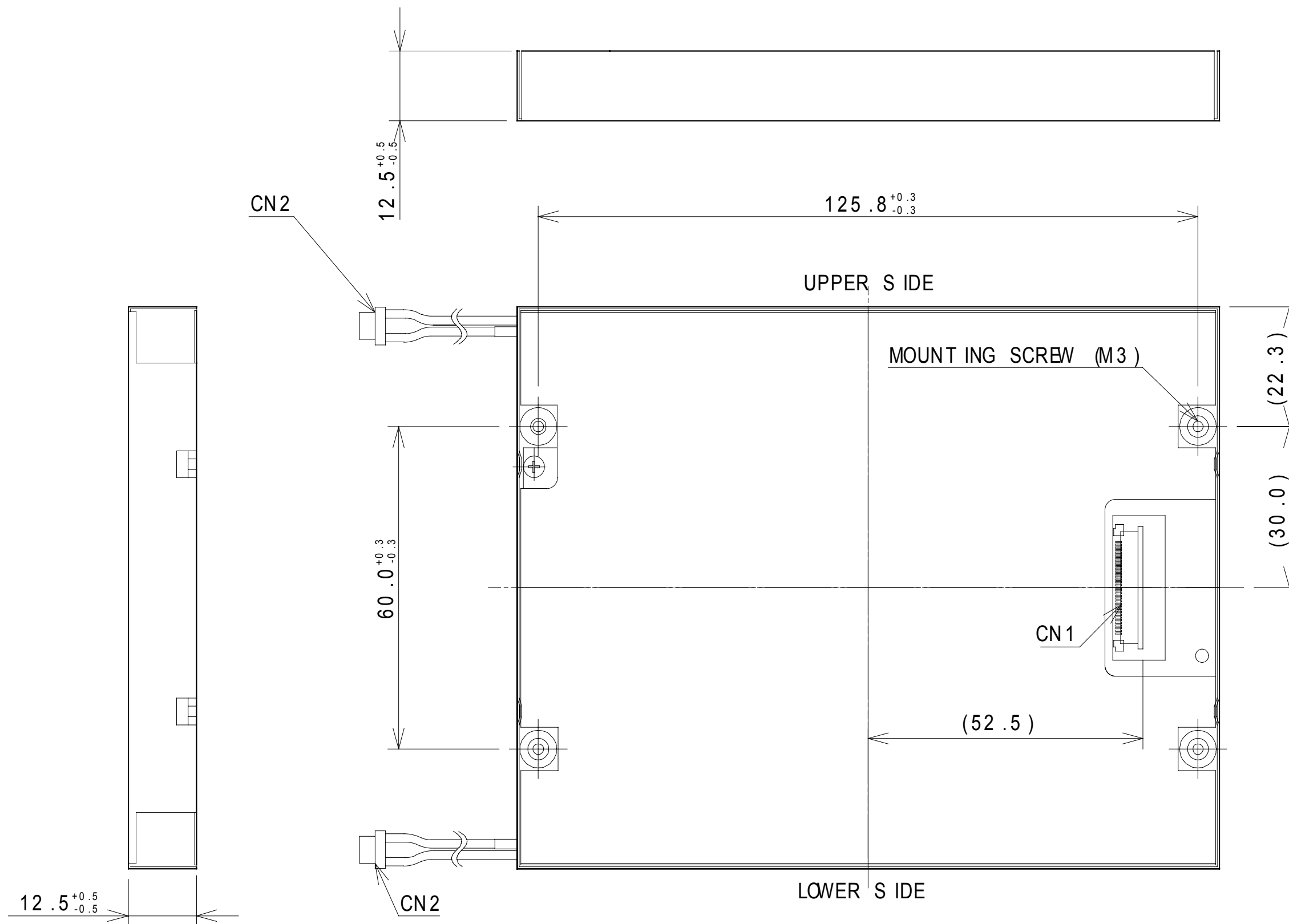

Unit: mm





## REVISION HISTORY

Edition	Document number	Prepared date	Revision contents and writer																																																																																																																																																																																																														
2nd edition	DOD - M - 0577	Aug. 27, 2001	<p data-bbox="611 439 767 470"><b>(3) page 7/24</b></p> <p data-bbox="651 472 1134 501"><b>7.2 ABSOLUTE MAXIMUM RATINGS</b></p> <table border="1" data-bbox="663 506 1477 730"> <thead> <tr> <th>Parameters</th> <th>Symbols</th> <th>Ratings</th> <th>Units</th> <th>Remarks</th> </tr> </thead> <tbody> <tr> <td>Supply voltage</td> <td>VCC</td> <td>-0.3 to +6.5</td> <td>V</td> <td rowspan="2">Ta=25°C</td> </tr> <tr> <td>Logic Input voltage</td> <td>VI</td> <td>-0.3 to VCC+0.3</td> <td>V</td> </tr> <tr> <td>Lamp voltage</td> <td>VL</td> <td>TBD</td> <td>Vrms</td> <td>-</td> </tr> <tr> <td>Storage temp.</td> <td>Tst</td> <td>-30 to +80</td> <td>°C</td> <td>-</td> </tr> <tr> <td>Operation temp.</td> <td>Top</td> <td>-10 to +70</td> <td>°C</td> <td>module surface Note 1</td> </tr> <tr> <td>Relative humidity</td> <td></td> <td>≤95</td> <td>%</td> <td>Ta ≤ 40 °C</td> </tr> <tr> <td>Note 2</td> <td></td> <td>≤85</td> <td>%</td> <td>40 &lt; Ta ≤ 50 °C</td> </tr> <tr> <td>Absolute humidity</td> <td></td> <td colspan="2">Absolute humidity shall not exceed</td> <td></td> </tr> <tr> <td>Note 2</td> <td></td> <td colspan="2">Ta=50°C, RH= 85% level</td> <td>Ta &gt; 50 °C</td> </tr> </tbody> </table> <p data-bbox="638 757 667 779">→</p> <p data-bbox="651 784 767 815"><b>page 8/35</b></p> <p data-bbox="651 817 1118 846"><b>4.2 ABSOLUTE MAXIMUM RATINGS</b></p> <table border="1" data-bbox="659 846 1481 1489"> <thead> <tr> <th colspan="2">Parameter</th> <th>Symbol</th> <th>Rating</th> <th>Unit</th> <th>Remarks</th> </tr> </thead> <tbody> <tr> <td>Supply voltage</td> <td colspan="2">LCD panel signal board and driver</td> <td>VCC</td> <td>-0.3 to +6.5</td> <td>V</td> <td rowspan="5">Ta = 25°C</td> </tr> <tr> <td rowspan="4">Input voltage</td> <td rowspan="2">LCD panel signal board</td> <td>Display signals Note1</td> <td>ViD</td> <td>-0.3 to VCC+0.3</td> <td>V</td> </tr> <tr> <td>Function signals Note2</td> <td>ViF</td> <td>-0.3 to VCC+0.3</td> <td>V</td> </tr> <tr> <td rowspan="2">Lamp</td> <td>High voltage side (Hot) Note3</td> <td>ViBLH</td> <td>TBD</td> <td>Vrms</td> </tr> <tr> <td>Low voltage side (Cold) Note4</td> <td>ViBLC</td> <td>TBD</td> <td>Vrms</td> </tr> <tr> <td colspan="3">Storage temperature</td> <td>Tst</td> <td>-30 to +80</td> <td>°C</td> <td rowspan="3">-</td> </tr> <tr> <td rowspan="2">Operating temperature</td> <td colspan="2">Front surface</td> <td>TopF</td> <td>-10 to +70</td> <td>°C</td> </tr> <tr> <td colspan="2">Rear surface</td> <td>TopR</td> <td>TBD</td> <td>°C</td> </tr> <tr> <td colspan="3" rowspan="4">Relative humidity Note5</td> <td rowspan="4">RH</td> <td>≤ 95</td> <td>%</td> <td>Ta ≤ 40 °C</td> </tr> <tr> <td>≤ 85</td> <td>%</td> <td>40 &lt; Ta ≤ 50 °C</td> </tr> <tr> <td>≤ 60</td> <td>%</td> <td>50 &lt; Ta ≤ 60 °C</td> </tr> <tr> <td>≤ 42</td> <td>%</td> <td>60 &lt; Ta ≤ 70 °C</td> </tr> <tr> <td colspan="3">Absolute humidity Note5</td> <td>-</td> <td>≤ 78 Note6</td> <td>g/m<sup>3</sup></td> <td>Ta &gt; 70°C</td> </tr> </tbody> </table> <p data-bbox="611 1534 767 1568"><b>(4) page 8/24</b></p> <p data-bbox="651 1570 802 1601"><b>(2) Backlight</b></p> <table border="1" data-bbox="659 1608 1489 1758"> <thead> <tr> <th>Parameters</th> <th>Symbols</th> <th>Min.</th> <th>Typ.</th> <th>Max.</th> <th>Units</th> <th>Remarks</th> </tr> </thead> <tbody> <tr> <td>Supply current</td> <td>IL</td> <td>TBD</td> <td>5.0</td> <td>TBD</td> <td>mArms</td> <td>With one lamp</td> </tr> <tr> <td>Supply voltage</td> <td>VL</td> <td>-</td> <td>350</td> <td>-</td> <td>Vrms</td> <td>-</td> </tr> <tr> <td rowspan="2">Lamp turn on voltage</td> <td rowspan="2">VS</td> <td>TBD</td> <td>-</td> <td>-</td> <td rowspan="2">Vrms</td> <td>Ta=25°C</td> </tr> <tr> <td>TBD</td> <td>-</td> <td>-</td> <td>Ta=0°C</td> </tr> <tr> <td>Oscillator frequency</td> <td>Ft</td> <td>TBD</td> <td>-</td> <td>-</td> <td>kHz</td> <td>Note 1</td> </tr> </tbody> </table> <p data-bbox="638 1787 667 1809">→</p> <p data-bbox="651 1814 767 1845"><b>page 9/35</b></p> <p data-bbox="651 1848 967 1879"><b>4.3.2 Working for backlight</b></p> <table border="1" data-bbox="659 1883 1489 2033"> <thead> <tr> <th>Parameter</th> <th>Symbol</th> <th>Ta</th> <th>Min.</th> <th>Typ.</th> <th>Max.</th> <th>Unit</th> <th>Remarks</th> </tr> </thead> <tbody> <tr> <td rowspan="2">Starting voltage</td> <td rowspan="2">VS</td> <td>0°C</td> <td>720</td> <td>-</td> <td>-</td> <td>Vrms</td> <td rowspan="2">Note1</td> </tr> <tr> <td>25°C</td> <td>570</td> <td>-</td> <td>-</td> <td>Vrms</td> </tr> <tr> <td>Supply voltage</td> <td>ViBLH</td> <td>25°C</td> <td>-</td> <td>350</td> <td>-</td> <td>Vrms</td> <td>Note1, Note2</td> </tr> <tr> <td>Supply current</td> <td>IiBL</td> <td>25°C</td> <td>3.0</td> <td>5.0</td> <td>5.5</td> <td>mArms</td> <td>Note2, Note3</td> </tr> <tr> <td>Oscillation frequency</td> <td>Ft</td> <td>25°C</td> <td>40</td> <td>45</td> <td>50</td> <td>kHz</td> <td>Note4</td> </tr> </tbody> </table>	Parameters	Symbols	Ratings	Units	Remarks	Supply voltage	VCC	-0.3 to +6.5	V	Ta=25°C	Logic Input voltage	VI	-0.3 to VCC+0.3	V	Lamp voltage	VL	TBD	Vrms	-	Storage temp.	Tst	-30 to +80	°C	-	Operation temp.	Top	-10 to +70	°C	module surface Note 1	Relative humidity		≤95	%	Ta ≤ 40 °C	Note 2		≤85	%	40 < Ta ≤ 50 °C	Absolute humidity		Absolute humidity shall not exceed			Note 2		Ta=50°C, RH= 85% level		Ta > 50 °C	Parameter		Symbol	Rating	Unit	Remarks	Supply voltage	LCD panel signal board and driver		VCC	-0.3 to +6.5	V	Ta = 25°C	Input voltage	LCD panel signal board	Display signals Note1	ViD	-0.3 to VCC+0.3	V	Function signals Note2	ViF	-0.3 to VCC+0.3	V	Lamp	High voltage side (Hot) Note3	ViBLH	TBD	Vrms	Low voltage side (Cold) Note4	ViBLC	TBD	Vrms	Storage temperature			Tst	-30 to +80	°C	-	Operating temperature	Front surface		TopF	-10 to +70	°C	Rear surface		TopR	TBD	°C	Relative humidity Note5			RH	≤ 95	%	Ta ≤ 40 °C	≤ 85	%	40 < Ta ≤ 50 °C	≤ 60	%	50 < Ta ≤ 60 °C	≤ 42	%	60 < Ta ≤ 70 °C	Absolute humidity Note5			-	≤ 78 Note6	g/m <sup>3</sup>	Ta > 70°C	Parameters	Symbols	Min.	Typ.	Max.	Units	Remarks	Supply current	IL	TBD	5.0	TBD	mArms	With one lamp	Supply voltage	VL	-	350	-	Vrms	-	Lamp turn on voltage	VS	TBD	-	-	Vrms	Ta=25°C	TBD	-	-	Ta=0°C	Oscillator frequency	Ft	TBD	-	-	kHz	Note 1	Parameter	Symbol	Ta	Min.	Typ.	Max.	Unit	Remarks	Starting voltage	VS	0°C	720	-	-	Vrms	Note1	25°C	570	-	-	Vrms	Supply voltage	ViBLH	25°C	-	350	-	Vrms	Note1, Note2	Supply current	IiBL	25°C	3.0	5.0	5.5	mArms	Note2, Note3	Oscillation frequency	Ft	25°C	40	45	50	kHz	Note4
Parameters	Symbols	Ratings	Units	Remarks																																																																																																																																																																																																													
Supply voltage	VCC	-0.3 to +6.5	V	Ta=25°C																																																																																																																																																																																																													
Logic Input voltage	VI	-0.3 to VCC+0.3	V																																																																																																																																																																																																														
Lamp voltage	VL	TBD	Vrms	-																																																																																																																																																																																																													
Storage temp.	Tst	-30 to +80	°C	-																																																																																																																																																																																																													
Operation temp.	Top	-10 to +70	°C	module surface Note 1																																																																																																																																																																																																													
Relative humidity		≤95	%	Ta ≤ 40 °C																																																																																																																																																																																																													
Note 2		≤85	%	40 < Ta ≤ 50 °C																																																																																																																																																																																																													
Absolute humidity		Absolute humidity shall not exceed																																																																																																																																																																																																															
Note 2		Ta=50°C, RH= 85% level		Ta > 50 °C																																																																																																																																																																																																													
Parameter		Symbol	Rating	Unit	Remarks																																																																																																																																																																																																												
Supply voltage	LCD panel signal board and driver		VCC	-0.3 to +6.5	V	Ta = 25°C																																																																																																																																																																																																											
Input voltage	LCD panel signal board	Display signals Note1	ViD	-0.3 to VCC+0.3	V																																																																																																																																																																																																												
		Function signals Note2	ViF	-0.3 to VCC+0.3	V																																																																																																																																																																																																												
	Lamp	High voltage side (Hot) Note3	ViBLH	TBD	Vrms																																																																																																																																																																																																												
		Low voltage side (Cold) Note4	ViBLC	TBD	Vrms																																																																																																																																																																																																												
Storage temperature			Tst	-30 to +80	°C	-																																																																																																																																																																																																											
Operating temperature	Front surface		TopF	-10 to +70	°C																																																																																																																																																																																																												
	Rear surface		TopR	TBD	°C																																																																																																																																																																																																												
Relative humidity Note5			RH	≤ 95	%	Ta ≤ 40 °C																																																																																																																																																																																																											
				≤ 85	%	40 < Ta ≤ 50 °C																																																																																																																																																																																																											
				≤ 60	%	50 < Ta ≤ 60 °C																																																																																																																																																																																																											
				≤ 42	%	60 < Ta ≤ 70 °C																																																																																																																																																																																																											
Absolute humidity Note5			-	≤ 78 Note6	g/m <sup>3</sup>	Ta > 70°C																																																																																																																																																																																																											
Parameters	Symbols	Min.	Typ.	Max.	Units	Remarks																																																																																																																																																																																																											
Supply current	IL	TBD	5.0	TBD	mArms	With one lamp																																																																																																																																																																																																											
Supply voltage	VL	-	350	-	Vrms	-																																																																																																																																																																																																											
Lamp turn on voltage	VS	TBD	-	-	Vrms	Ta=25°C																																																																																																																																																																																																											
		TBD	-	-		Ta=0°C																																																																																																																																																																																																											
Oscillator frequency	Ft	TBD	-	-	kHz	Note 1																																																																																																																																																																																																											
Parameter	Symbol	Ta	Min.	Typ.	Max.	Unit	Remarks																																																																																																																																																																																																										
Starting voltage	VS	0°C	720	-	-	Vrms	Note1																																																																																																																																																																																																										
		25°C	570	-	-	Vrms																																																																																																																																																																																																											
Supply voltage	ViBLH	25°C	-	350	-	Vrms	Note1, Note2																																																																																																																																																																																																										
Supply current	IiBL	25°C	3.0	5.0	5.5	mArms	Note2, Note3																																																																																																																																																																																																										
Oscillation frequency	Ft	25°C	40	45	50	kHz	Note4																																																																																																																																																																																																										

## REVISION HISTORY

Edition	Document number	Prepared date	Revision contents and writer																																																																																																																																																																																																																																																										
2nd edition	DOD - M - 0577	Aug. 27, 2001	<p><b>(5) page 9/24</b></p> <p>(1) Interface signals, power supply</p> <p>Module side connector</p> <p>CN1 socket: IL-FPR-33S-HF (Supplier: Japan Aviation Electronics Industry limited (JAE) )</p> <p>Adaptable FPC plug</p> <p>TBD (Supplier: TBD)</p> <table border="1" style="width: 100%; border-collapse: collapse;"> <thead> <tr> <th style="text-align: center;">Pin No.</th> <th style="text-align: center;">Symbols</th> <th style="text-align: center;">Functions</th> <th style="text-align: center;">Pin No.</th> <th style="text-align: center;">Symbols</th> <th style="text-align: center;">Functions</th> </tr> </thead> <tbody> <tr><td style="text-align: center;">1</td><td style="text-align: center;">GND</td><td style="text-align: center;">Ground</td><td style="text-align: center;">19</td><td style="text-align: center;">GND</td><td style="text-align: center;">Ground</td></tr> <tr><td style="text-align: center;">2</td><td style="text-align: center;">CLK</td><td style="text-align: center;">Dot clock</td><td style="text-align: center;">20</td><td style="text-align: center;">B0</td><td style="text-align: center;">Blue data (LSB)</td></tr> <tr><td style="text-align: center;">3</td><td style="text-align: center;">Hsync</td><td style="text-align: center;">Horizontal sync.</td><td style="text-align: center;">21</td><td style="text-align: center;">B1</td><td style="text-align: center;">Blue data</td></tr> <tr><td style="text-align: center;">4</td><td style="text-align: center;">Vsync</td><td style="text-align: center;">Vertical sync.</td><td style="text-align: center;">22</td><td style="text-align: center;">B2</td><td style="text-align: center;">Blue data</td></tr> <tr><td style="text-align: center;">5</td><td style="text-align: center;">GND</td><td style="text-align: center;">Ground</td><td style="text-align: center;">23</td><td style="text-align: center;">B3</td><td style="text-align: center;">Blue data</td></tr> <tr><td style="text-align: center;">6</td><td style="text-align: center;">R0</td><td style="text-align: center;">Red data (LSB)</td><td style="text-align: center;">24</td><td style="text-align: center;">B4</td><td style="text-align: center;">Blue data</td></tr> <tr><td style="text-align: center;">7</td><td style="text-align: center;">R1</td><td style="text-align: center;">Red data</td><td style="text-align: center;">25</td><td style="text-align: center;">B5</td><td style="text-align: center;">Blue data (MSB)</td></tr> <tr><td style="text-align: center;">8</td><td style="text-align: center;">R2</td><td style="text-align: center;">Red data</td><td style="text-align: center;">26</td><td style="text-align: center;">GND</td><td style="text-align: center;">Ground</td></tr> <tr><td style="text-align: center;">9</td><td style="text-align: center;">R3</td><td style="text-align: center;">Red data</td><td style="text-align: center;">27</td><td style="text-align: center;">DE</td><td style="text-align: center;">Data enable Note 2</td></tr> <tr><td style="text-align: center;">10</td><td style="text-align: center;">R4</td><td style="text-align: center;">Red data</td><td style="text-align: center;">28</td><td style="text-align: center;">VCC</td><td style="text-align: center;">Power supply Note 1</td></tr> <tr><td style="text-align: center;">11</td><td style="text-align: center;">R5</td><td style="text-align: center;">Red data (MSB)</td><td style="text-align: center;">29</td><td style="text-align: center;">VCC</td><td style="text-align: center;">Power supply Note 1</td></tr> <tr><td style="text-align: center;">12</td><td style="text-align: center;">GND</td><td style="text-align: center;">Ground</td><td style="text-align: center;">30</td><td style="text-align: center;">R/L</td><td style="text-align: center;">Mode select signal Note 3</td></tr> <tr><td style="text-align: center;">13</td><td style="text-align: center;">G0</td><td style="text-align: center;">Green data (LSB)</td><td style="text-align: center;">31</td><td style="text-align: center;">U/D</td><td style="text-align: center;">Mode select signal Note 3</td></tr> <tr><td style="text-align: center;">14</td><td style="text-align: center;">G1</td><td style="text-align: center;">Green data</td><td style="text-align: center;">32</td><td style="text-align: center;">GND</td><td style="text-align: center;">Ground</td></tr> <tr><td style="text-align: center;">15</td><td style="text-align: center;">G2</td><td style="text-align: center;">Green data</td><td style="text-align: center;">33</td><td style="text-align: center;">GND</td><td style="text-align: center;">Ground</td></tr> <tr><td style="text-align: center;">16</td><td style="text-align: center;">G3</td><td style="text-align: center;">Green data</td><td></td><td></td><td></td></tr> <tr><td style="text-align: center;">17</td><td style="text-align: center;">G4</td><td style="text-align: center;">Green data</td><td></td><td></td><td></td></tr> <tr><td style="text-align: center;">18</td><td style="text-align: center;">G5</td><td style="text-align: center;">Green data (MSB)</td><td></td><td></td><td></td></tr> </tbody> </table> <p style="text-align: center;">→</p> <p><b>page 12/35</b></p> <p>4.5.1 LCD panel signal processing board</p> <p>CN1 socket (LCD module side): 08-6210-033-340-800 (Kyocera Elco Corp.)</p> <p>Adaptable plug: Flexible cable</p> <table border="1" style="width: 100%; border-collapse: collapse;"> <thead> <tr> <th style="text-align: center;">Pin No.</th> <th style="text-align: center;">Symbol</th> <th style="text-align: center;">Signal</th> <th style="text-align: center;">Remarks</th> </tr> </thead> <tbody> <tr><td style="text-align: center;">1</td><td style="text-align: center;">GND</td><td style="text-align: center;">Ground</td><td></td></tr> <tr><td style="text-align: center;">2</td><td style="text-align: center;">CLK</td><td style="text-align: center;">Dot clock</td><td></td></tr> <tr><td style="text-align: center;">3</td><td style="text-align: center;">Hsync</td><td style="text-align: center;">Horizontal synchronous</td><td style="text-align: center;">-</td></tr> <tr><td style="text-align: center;">4</td><td style="text-align: center;">Vsync</td><td style="text-align: center;">Vertical synchronous</td><td></td></tr> <tr><td style="text-align: center;">5</td><td style="text-align: center;">GND</td><td style="text-align: center;">Ground</td><td></td></tr> <tr><td style="text-align: center;">6</td><td style="text-align: center;">R0</td><td style="text-align: center;">Red data (LSB)</td><td style="text-align: center;">Least significant bit</td></tr> <tr><td style="text-align: center;">7</td><td style="text-align: center;">R1</td><td style="text-align: center;">Red data</td><td></td></tr> <tr><td style="text-align: center;">8</td><td style="text-align: center;">R2</td><td style="text-align: center;">Red data</td><td></td></tr> <tr><td style="text-align: center;">9</td><td style="text-align: center;">R3</td><td style="text-align: center;">Red data</td><td style="text-align: center;">-</td></tr> <tr><td style="text-align: center;">10</td><td style="text-align: center;">R4</td><td style="text-align: center;">Red data</td><td></td></tr> <tr><td style="text-align: center;">11</td><td style="text-align: center;">R5</td><td style="text-align: center;">Red data (MSB)</td><td style="text-align: center;">Most significant bit</td></tr> <tr><td style="text-align: center;">12</td><td style="text-align: center;">GND</td><td style="text-align: center;">Ground</td><td style="text-align: center;">-</td></tr> <tr><td style="text-align: center;">13</td><td style="text-align: center;">G0</td><td style="text-align: center;">Green data (LSB)</td><td style="text-align: center;">Least significant bit</td></tr> <tr><td style="text-align: center;">14</td><td style="text-align: center;">G1</td><td style="text-align: center;">Green data</td><td></td></tr> <tr><td style="text-align: center;">15</td><td style="text-align: center;">G2</td><td style="text-align: center;">Green data</td><td></td></tr> <tr><td style="text-align: center;">16</td><td style="text-align: center;">G3</td><td style="text-align: center;">Green data</td><td style="text-align: center;">-</td></tr> <tr><td style="text-align: center;">17</td><td style="text-align: center;">G4</td><td style="text-align: center;">Green data</td><td></td></tr> <tr><td style="text-align: center;">18</td><td style="text-align: center;">G5</td><td style="text-align: center;">Green data (MSB)</td><td style="text-align: center;">Most significant bit</td></tr> <tr><td style="text-align: center;">19</td><td style="text-align: center;">GND</td><td style="text-align: center;">Ground</td><td style="text-align: center;">-</td></tr> <tr><td style="text-align: center;">20</td><td style="text-align: center;">B0</td><td style="text-align: center;">Blue data (LSB)</td><td style="text-align: center;">Least significant bit</td></tr> <tr><td style="text-align: center;">21</td><td style="text-align: center;">B1</td><td style="text-align: center;">Blue data</td><td></td></tr> <tr><td style="text-align: center;">22</td><td style="text-align: center;">B2</td><td style="text-align: center;">Blue data</td><td></td></tr> <tr><td style="text-align: center;">23</td><td style="text-align: center;">B3</td><td style="text-align: center;">Blue data</td><td style="text-align: center;">-</td></tr> <tr><td style="text-align: center;">24</td><td style="text-align: center;">B4</td><td style="text-align: center;">Blue data</td><td></td></tr> <tr><td style="text-align: center;">25</td><td style="text-align: center;">B5</td><td style="text-align: center;">Blue data (MSB)</td><td style="text-align: center;">Most significant bit</td></tr> <tr><td style="text-align: center;">26</td><td style="text-align: center;">GND</td><td style="text-align: center;">Ground</td><td style="text-align: center;">-</td></tr> <tr><td style="text-align: center;">27</td><td style="text-align: center;">DE</td><td style="text-align: center;">Select of DE / Fixed mode</td><td style="text-align: center;">DE mode: Data enable signal, Fixed mode: Open</td></tr> <tr><td style="text-align: center;">28</td><td style="text-align: center;">VCC</td><td style="text-align: center;">Power supply</td><td></td></tr> <tr><td style="text-align: center;">29</td><td style="text-align: center;">VCC</td><td style="text-align: center;">Power supply</td><td style="text-align: center;">-</td></tr> <tr><td style="text-align: center;">30</td><td style="text-align: center;">DPSH</td><td style="text-align: center;">Select of scan direction (Horizontal)</td><td style="text-align: center;">Normal scan: Low or Open, Reverse scan: High Note1</td></tr> <tr><td style="text-align: center;">31</td><td style="text-align: center;">DPSV</td><td style="text-align: center;">Select of scan direction (Vertical)</td><td style="text-align: center;">Note1</td></tr> <tr><td style="text-align: center;">32</td><td style="text-align: center;">PNS</td><td style="text-align: center;">Select of pixel number</td><td style="text-align: center;">QVGA mode: High, VGA mode: Low or Open Note1</td></tr> <tr><td style="text-align: center;">33</td><td style="text-align: center;">GND</td><td style="text-align: center;">Ground</td><td style="text-align: center;">-</td></tr> </tbody> </table>	Pin No.	Symbols	Functions	Pin No.	Symbols	Functions	1	GND	Ground	19	GND	Ground	2	CLK	Dot clock	20	B0	Blue data (LSB)	3	Hsync	Horizontal sync.	21	B1	Blue data	4	Vsync	Vertical sync.	22	B2	Blue data	5	GND	Ground	23	B3	Blue data	6	R0	Red data (LSB)	24	B4	Blue data	7	R1	Red data	25	B5	Blue data (MSB)	8	R2	Red data	26	GND	Ground	9	R3	Red data	27	DE	Data enable Note 2	10	R4	Red data	28	VCC	Power supply Note 1	11	R5	Red data (MSB)	29	VCC	Power supply Note 1	12	GND	Ground	30	R/L	Mode select signal Note 3	13	G0	Green data (LSB)	31	U/D	Mode select signal Note 3	14	G1	Green data	32	GND	Ground	15	G2	Green data	33	GND	Ground	16	G3	Green data				17	G4	Green data				18	G5	Green data (MSB)				Pin No.	Symbol	Signal	Remarks	1	GND	Ground		2	CLK	Dot clock		3	Hsync	Horizontal synchronous	-	4	Vsync	Vertical synchronous		5	GND	Ground		6	R0	Red data (LSB)	Least significant bit	7	R1	Red data		8	R2	Red data		9	R3	Red data	-	10	R4	Red data		11	R5	Red data (MSB)	Most significant bit	12	GND	Ground	-	13	G0	Green data (LSB)	Least significant bit	14	G1	Green data		15	G2	Green data		16	G3	Green data	-	17	G4	Green data		18	G5	Green data (MSB)	Most significant bit	19	GND	Ground	-	20	B0	Blue data (LSB)	Least significant bit	21	B1	Blue data		22	B2	Blue data		23	B3	Blue data	-	24	B4	Blue data		25	B5	Blue data (MSB)	Most significant bit	26	GND	Ground	-	27	DE	Select of DE / Fixed mode	DE mode: Data enable signal, Fixed mode: Open	28	VCC	Power supply		29	VCC	Power supply	-	30	DPSH	Select of scan direction (Horizontal)	Normal scan: Low or Open, Reverse scan: High Note1	31	DPSV	Select of scan direction (Vertical)	Note1	32	PNS	Select of pixel number	QVGA mode: High, VGA mode: Low or Open Note1	33	GND	Ground	-
Pin No.	Symbols	Functions	Pin No.	Symbols	Functions																																																																																																																																																																																																																																																								
1	GND	Ground	19	GND	Ground																																																																																																																																																																																																																																																								
2	CLK	Dot clock	20	B0	Blue data (LSB)																																																																																																																																																																																																																																																								
3	Hsync	Horizontal sync.	21	B1	Blue data																																																																																																																																																																																																																																																								
4	Vsync	Vertical sync.	22	B2	Blue data																																																																																																																																																																																																																																																								
5	GND	Ground	23	B3	Blue data																																																																																																																																																																																																																																																								
6	R0	Red data (LSB)	24	B4	Blue data																																																																																																																																																																																																																																																								
7	R1	Red data	25	B5	Blue data (MSB)																																																																																																																																																																																																																																																								
8	R2	Red data	26	GND	Ground																																																																																																																																																																																																																																																								
9	R3	Red data	27	DE	Data enable Note 2																																																																																																																																																																																																																																																								
10	R4	Red data	28	VCC	Power supply Note 1																																																																																																																																																																																																																																																								
11	R5	Red data (MSB)	29	VCC	Power supply Note 1																																																																																																																																																																																																																																																								
12	GND	Ground	30	R/L	Mode select signal Note 3																																																																																																																																																																																																																																																								
13	G0	Green data (LSB)	31	U/D	Mode select signal Note 3																																																																																																																																																																																																																																																								
14	G1	Green data	32	GND	Ground																																																																																																																																																																																																																																																								
15	G2	Green data	33	GND	Ground																																																																																																																																																																																																																																																								
16	G3	Green data																																																																																																																																																																																																																																																											
17	G4	Green data																																																																																																																																																																																																																																																											
18	G5	Green data (MSB)																																																																																																																																																																																																																																																											
Pin No.	Symbol	Signal	Remarks																																																																																																																																																																																																																																																										
1	GND	Ground																																																																																																																																																																																																																																																											
2	CLK	Dot clock																																																																																																																																																																																																																																																											
3	Hsync	Horizontal synchronous	-																																																																																																																																																																																																																																																										
4	Vsync	Vertical synchronous																																																																																																																																																																																																																																																											
5	GND	Ground																																																																																																																																																																																																																																																											
6	R0	Red data (LSB)	Least significant bit																																																																																																																																																																																																																																																										
7	R1	Red data																																																																																																																																																																																																																																																											
8	R2	Red data																																																																																																																																																																																																																																																											
9	R3	Red data	-																																																																																																																																																																																																																																																										
10	R4	Red data																																																																																																																																																																																																																																																											
11	R5	Red data (MSB)	Most significant bit																																																																																																																																																																																																																																																										
12	GND	Ground	-																																																																																																																																																																																																																																																										
13	G0	Green data (LSB)	Least significant bit																																																																																																																																																																																																																																																										
14	G1	Green data																																																																																																																																																																																																																																																											
15	G2	Green data																																																																																																																																																																																																																																																											
16	G3	Green data	-																																																																																																																																																																																																																																																										
17	G4	Green data																																																																																																																																																																																																																																																											
18	G5	Green data (MSB)	Most significant bit																																																																																																																																																																																																																																																										
19	GND	Ground	-																																																																																																																																																																																																																																																										
20	B0	Blue data (LSB)	Least significant bit																																																																																																																																																																																																																																																										
21	B1	Blue data																																																																																																																																																																																																																																																											
22	B2	Blue data																																																																																																																																																																																																																																																											
23	B3	Blue data	-																																																																																																																																																																																																																																																										
24	B4	Blue data																																																																																																																																																																																																																																																											
25	B5	Blue data (MSB)	Most significant bit																																																																																																																																																																																																																																																										
26	GND	Ground	-																																																																																																																																																																																																																																																										
27	DE	Select of DE / Fixed mode	DE mode: Data enable signal, Fixed mode: Open																																																																																																																																																																																																																																																										
28	VCC	Power supply																																																																																																																																																																																																																																																											
29	VCC	Power supply	-																																																																																																																																																																																																																																																										
30	DPSH	Select of scan direction (Horizontal)	Normal scan: Low or Open, Reverse scan: High Note1																																																																																																																																																																																																																																																										
31	DPSV	Select of scan direction (Vertical)	Note1																																																																																																																																																																																																																																																										
32	PNS	Select of pixel number	QVGA mode: High, VGA mode: Low or Open Note1																																																																																																																																																																																																																																																										
33	GND	Ground	-																																																																																																																																																																																																																																																										



## REVISION HISTORY

Edition	Document number	Prepared date	Revision contents and writer																																																																																																																																																																																																																																																												
2nd edition	DOD - M - 0577	Aug. 27, 2001	<p>(6) <i>page 18/24</i></p> <p><b>7.10. OPTICAL CHARACTERISTICS</b></p> <p style="text-align: right;">Ta = 25°C, Note 1</p> <table border="1"> <thead> <tr> <th>Parameters</th> <th>Symbols</th> <th>Conditions</th> <th>Min.</th> <th>Typ.</th> <th>Max.</th> <th>Units</th> <th>Remarks</th> </tr> </thead> <tbody> <tr> <td>Luminance</td> <td>Lumax</td> <td>Note 3</td> <td>320</td> <td>400</td> <td>-</td> <td>cd/m<sup>2</sup></td> <td>Note 2</td> </tr> <tr> <td>Contrast ratio</td> <td>CR</td> <td>Note 3</td> <td>TBD</td> <td>300</td> <td>-</td> <td>-</td> <td>Note 4</td> </tr> <tr> <td>Luminance uniformity</td> <td>-</td> <td>Max. /Min.</td> <td>-</td> <td>TBD</td> <td>TBD</td> <td>-</td> <td>Note 7</td> </tr> </tbody> </table> <p>Reference data</p> <p style="text-align: right;">Ta = 25°C, Note 1</p> <table border="1"> <thead> <tr> <th>Items</th> <th>Symbols</th> <th>Conditions</th> <th>Min.</th> <th>Typ.</th> <th>Max.</th> <th>Units</th> <th>Remarks</th> </tr> </thead> <tbody> <tr> <td>Color gamut</td> <td>C</td> <td>At center, to NTSC</td> <td>TBD</td> <td>50</td> <td>-</td> <td>%</td> <td>-</td> </tr> <tr> <td rowspan="4">Chromaticity coordinate</td> <td>W</td> <td>White (x, y) Note 3</td> <td>TBD</td> <td>TBD</td> <td>TBD</td> <td>-</td> <td rowspan="4">-</td> </tr> <tr> <td>R</td> <td>Red (x, y) Note 3</td> <td>-</td> <td>TBD</td> <td>-</td> <td>-</td> </tr> <tr> <td>G</td> <td>Green (x, y) Note 3</td> <td>-</td> <td>TBD</td> <td>-</td> <td>-</td> </tr> <tr> <td>B</td> <td>Blue (x, y) Note 3</td> <td>-</td> <td>TBD</td> <td>-</td> <td>-</td> </tr> <tr> <td rowspan="4">Viewing angle range</td> <td rowspan="2">Horizontal</td> <td><math>\theta_{x+}</math></td> <td><math>CR &gt; 5, \theta_{y=\pm 0^\circ}</math></td> <td>TBD</td> <td>65</td> <td>-</td> <td>deg.</td> <td rowspan="4">Note 5</td> </tr> <tr> <td><math>\theta_{x-}</math></td> <td><math>CR &gt; 5, \theta_{y=\pm 0^\circ}</math></td> <td>TBD</td> <td>65</td> <td>-</td> <td>deg.</td> </tr> <tr> <td rowspan="2">Vertical</td> <td><math>\theta_{y+}</math></td> <td><math>CR &gt; 5, \theta_{x=\pm 0^\circ}</math></td> <td>TBD</td> <td>40</td> <td>-</td> <td>deg.</td> </tr> <tr> <td><math>\theta_{y-}</math></td> <td><math>CR &gt; 5, \theta_{x=\pm 0^\circ}</math></td> <td>TBD</td> <td>65</td> <td>-</td> <td>deg.</td> </tr> <tr> <td rowspan="4">Response time</td> <td rowspan="2">Ton</td> <td>White to Black</td> <td>(100%→10%)</td> <td>-</td> <td>TBD</td> <td>30</td> <td>ms</td> <td rowspan="4">Note 6</td> </tr> <tr> <td>Black to White</td> <td>(90%→10%)</td> <td>-</td> <td>TBD</td> <td>-</td> <td>-</td> </tr> <tr> <td rowspan="2">Toff</td> <td>Black to White</td> <td>(0%→90%)</td> <td>-</td> <td>TBD</td> <td>60</td> <td>ms</td> </tr> <tr> <td>White to Black</td> <td>(10%→90%)</td> <td>-</td> <td>TBD</td> <td>-</td> <td>-</td> </tr> </tbody> </table> <p>→</p> <p><i>page 20/35</i></p> <p><b>4.10.1 Optical characteristics</b></p> <table border="1"> <thead> <tr> <th>Parameter</th> <th>Note1</th> <th>Symbol</th> <th>Condition</th> <th>Min.</th> <th>Typ.</th> <th>Max.</th> <th>Unit</th> <th>Remarks</th> </tr> </thead> <tbody> <tr> <td>Contrast ratio</td> <td></td> <td>CR</td> <td>White/Black at center <math>\theta_R = 0^\circ, \theta_L = 0^\circ, \theta_U = 0^\circ, \theta_D = 0^\circ</math></td> <td>320</td> <td>400</td> <td>-</td> <td>-</td> <td>Note2</td> </tr> <tr> <td>Luminance</td> <td></td> <td>L</td> <td>White at center <math>\theta_R = 0^\circ, \theta_L = 0^\circ, \theta_U = 0^\circ, \theta_D = 0^\circ</math></td> <td>240</td> <td>300</td> <td>-</td> <td>cd/m<sup>2</sup></td> <td>-</td> </tr> <tr> <td>Luminance uniformity</td> <td></td> <td>LU</td> <td>-</td> <td>-</td> <td>1.25</td> <td>1.45</td> <td>-</td> <td>Note3</td> </tr> <tr> <td rowspan="4">Chromaticity</td> <td></td> <td>W</td> <td>White (x, y)</td> <td>-</td> <td>0.305, 0.330</td> <td>-</td> <td>-</td> <td rowspan="4">-</td> </tr> <tr> <td></td> <td>R</td> <td>Red (x, y)</td> <td>-</td> <td>TBD, TBD</td> <td>-</td> <td>-</td> </tr> <tr> <td></td> <td>G</td> <td>Green (x, y)</td> <td>-</td> <td>TBD, TBD</td> <td>-</td> <td>-</td> </tr> <tr> <td></td> <td>B</td> <td>Blue (x, y)</td> <td>-</td> <td>TBD, TBD</td> <td>-</td> <td>-</td> </tr> <tr> <td>Color gamut</td> <td></td> <td>C</td> <td><math>\theta_R = 0^\circ, \theta_L = 0^\circ, \theta_U = 0^\circ, \theta_D = 0^\circ</math> at center, against NTSC color space</td> <td>-</td> <td>50</td> <td>-</td> <td>%</td> <td>-</td> </tr> <tr> <td rowspan="2">Response time Note4</td> <td></td> <td>Ton</td> <td>White to Black</td> <td>-</td> <td>3</td> <td>15</td> <td>ms</td> <td rowspan="2">Note5</td> </tr> <tr> <td></td> <td>Toff</td> <td>Black to White</td> <td>-</td> <td>10</td> <td>30</td> <td>ms</td> </tr> <tr> <td rowspan="4">Viewing angle</td> <td rowspan="4">CR = 10</td> <td>Right</td> <td><math>\theta_R</math></td> <td><math>\theta_U = 0^\circ, \theta_D = 0^\circ</math></td> <td>-</td> <td>65</td> <td>-</td> <td>°</td> <td rowspan="4">Note6</td> </tr> <tr> <td>Left</td> <td><math>\theta_L</math></td> <td><math>\theta_U = 0^\circ, \theta_D = 0^\circ</math></td> <td>-</td> <td>65</td> <td>-</td> <td>°</td> </tr> <tr> <td>Up</td> <td><math>\theta_U</math></td> <td><math>\theta_R = 0^\circ, \theta_L = 0^\circ</math></td> <td>-</td> <td>40</td> <td>-</td> <td>°</td> </tr> <tr> <td>Down</td> <td><math>\theta_D</math></td> <td><math>\theta_R = 0^\circ, \theta_L = 0^\circ</math></td> <td>-</td> <td>65</td> <td>-</td> <td>°</td> </tr> </tbody> </table> <p><b>Writer</b></p> <p>Approved by _____ Checked by _____ Prepared by _____</p> <p style="text-align: center;">T. ITO _____ A. SAWADA _____</p>	Parameters	Symbols	Conditions	Min.	Typ.	Max.	Units	Remarks	Luminance	Lumax	Note 3	320	400	-	cd/m <sup>2</sup>	Note 2	Contrast ratio	CR	Note 3	TBD	300	-	-	Note 4	Luminance uniformity	-	Max. /Min.	-	TBD	TBD	-	Note 7	Items	Symbols	Conditions	Min.	Typ.	Max.	Units	Remarks	Color gamut	C	At center, to NTSC	TBD	50	-	%	-	Chromaticity coordinate	W	White (x, y) Note 3	TBD	TBD	TBD	-	-	R	Red (x, y) Note 3	-	TBD	-	-	G	Green (x, y) Note 3	-	TBD	-	-	B	Blue (x, y) Note 3	-	TBD	-	-	Viewing angle range	Horizontal	$\theta_{x+}$	$CR > 5, \theta_{y=\pm 0^\circ}$	TBD	65	-	deg.	Note 5	$\theta_{x-}$	$CR > 5, \theta_{y=\pm 0^\circ}$	TBD	65	-	deg.	Vertical	$\theta_{y+}$	$CR > 5, \theta_{x=\pm 0^\circ}$	TBD	40	-	deg.	$\theta_{y-}$	$CR > 5, \theta_{x=\pm 0^\circ}$	TBD	65	-	deg.	Response time	Ton	White to Black	(100%→10%)	-	TBD	30	ms	Note 6	Black to White	(90%→10%)	-	TBD	-	-	Toff	Black to White	(0%→90%)	-	TBD	60	ms	White to Black	(10%→90%)	-	TBD	-	-	Parameter	Note1	Symbol	Condition	Min.	Typ.	Max.	Unit	Remarks	Contrast ratio		CR	White/Black at center $\theta_R = 0^\circ, \theta_L = 0^\circ, \theta_U = 0^\circ, \theta_D = 0^\circ$	320	400	-	-	Note2	Luminance		L	White at center $\theta_R = 0^\circ, \theta_L = 0^\circ, \theta_U = 0^\circ, \theta_D = 0^\circ$	240	300	-	cd/m <sup>2</sup>	-	Luminance uniformity		LU	-	-	1.25	1.45	-	Note3	Chromaticity		W	White (x, y)	-	0.305, 0.330	-	-	-		R	Red (x, y)	-	TBD, TBD	-	-		G	Green (x, y)	-	TBD, TBD	-	-		B	Blue (x, y)	-	TBD, TBD	-	-	Color gamut		C	$\theta_R = 0^\circ, \theta_L = 0^\circ, \theta_U = 0^\circ, \theta_D = 0^\circ$ at center, against NTSC color space	-	50	-	%	-	Response time Note4		Ton	White to Black	-	3	15	ms	Note5		Toff	Black to White	-	10	30	ms	Viewing angle	CR = 10	Right	$\theta_R$	$\theta_U = 0^\circ, \theta_D = 0^\circ$	-	65	-	°	Note6	Left	$\theta_L$	$\theta_U = 0^\circ, \theta_D = 0^\circ$	-	65	-	°	Up	$\theta_U$	$\theta_R = 0^\circ, \theta_L = 0^\circ$	-	40	-	°	Down	$\theta_D$	$\theta_R = 0^\circ, \theta_L = 0^\circ$	-	65	-	°
Parameters	Symbols	Conditions	Min.	Typ.	Max.	Units	Remarks																																																																																																																																																																																																																																																								
Luminance	Lumax	Note 3	320	400	-	cd/m <sup>2</sup>	Note 2																																																																																																																																																																																																																																																								
Contrast ratio	CR	Note 3	TBD	300	-	-	Note 4																																																																																																																																																																																																																																																								
Luminance uniformity	-	Max. /Min.	-	TBD	TBD	-	Note 7																																																																																																																																																																																																																																																								
Items	Symbols	Conditions	Min.	Typ.	Max.	Units	Remarks																																																																																																																																																																																																																																																								
Color gamut	C	At center, to NTSC	TBD	50	-	%	-																																																																																																																																																																																																																																																								
Chromaticity coordinate	W	White (x, y) Note 3	TBD	TBD	TBD	-	-																																																																																																																																																																																																																																																								
	R	Red (x, y) Note 3	-	TBD	-	-																																																																																																																																																																																																																																																									
	G	Green (x, y) Note 3	-	TBD	-	-																																																																																																																																																																																																																																																									
	B	Blue (x, y) Note 3	-	TBD	-	-																																																																																																																																																																																																																																																									
Viewing angle range	Horizontal	$\theta_{x+}$	$CR > 5, \theta_{y=\pm 0^\circ}$	TBD	65	-	deg.	Note 5																																																																																																																																																																																																																																																							
		$\theta_{x-}$	$CR > 5, \theta_{y=\pm 0^\circ}$	TBD	65	-	deg.																																																																																																																																																																																																																																																								
	Vertical	$\theta_{y+}$	$CR > 5, \theta_{x=\pm 0^\circ}$	TBD	40	-	deg.																																																																																																																																																																																																																																																								
		$\theta_{y-}$	$CR > 5, \theta_{x=\pm 0^\circ}$	TBD	65	-	deg.																																																																																																																																																																																																																																																								
Response time	Ton	White to Black	(100%→10%)	-	TBD	30	ms	Note 6																																																																																																																																																																																																																																																							
		Black to White	(90%→10%)	-	TBD	-	-																																																																																																																																																																																																																																																								
	Toff	Black to White	(0%→90%)	-	TBD	60	ms																																																																																																																																																																																																																																																								
		White to Black	(10%→90%)	-	TBD	-	-																																																																																																																																																																																																																																																								
Parameter	Note1	Symbol	Condition	Min.	Typ.	Max.	Unit	Remarks																																																																																																																																																																																																																																																							
Contrast ratio		CR	White/Black at center $\theta_R = 0^\circ, \theta_L = 0^\circ, \theta_U = 0^\circ, \theta_D = 0^\circ$	320	400	-	-	Note2																																																																																																																																																																																																																																																							
Luminance		L	White at center $\theta_R = 0^\circ, \theta_L = 0^\circ, \theta_U = 0^\circ, \theta_D = 0^\circ$	240	300	-	cd/m <sup>2</sup>	-																																																																																																																																																																																																																																																							
Luminance uniformity		LU	-	-	1.25	1.45	-	Note3																																																																																																																																																																																																																																																							
Chromaticity		W	White (x, y)	-	0.305, 0.330	-	-	-																																																																																																																																																																																																																																																							
		R	Red (x, y)	-	TBD, TBD	-	-																																																																																																																																																																																																																																																								
		G	Green (x, y)	-	TBD, TBD	-	-																																																																																																																																																																																																																																																								
		B	Blue (x, y)	-	TBD, TBD	-	-																																																																																																																																																																																																																																																								
Color gamut		C	$\theta_R = 0^\circ, \theta_L = 0^\circ, \theta_U = 0^\circ, \theta_D = 0^\circ$ at center, against NTSC color space	-	50	-	%	-																																																																																																																																																																																																																																																							
Response time Note4		Ton	White to Black	-	3	15	ms	Note5																																																																																																																																																																																																																																																							
		Toff	Black to White	-	10	30	ms																																																																																																																																																																																																																																																								
Viewing angle	CR = 10	Right	$\theta_R$	$\theta_U = 0^\circ, \theta_D = 0^\circ$	-	65	-	°	Note6																																																																																																																																																																																																																																																						
		Left	$\theta_L$	$\theta_U = 0^\circ, \theta_D = 0^\circ$	-	65	-	°																																																																																																																																																																																																																																																							
		Up	$\theta_U$	$\theta_R = 0^\circ, \theta_L = 0^\circ$	-	40	-	°																																																																																																																																																																																																																																																							
		Down	$\theta_D$	$\theta_R = 0^\circ, \theta_L = 0^\circ$	-	65	-	°																																																																																																																																																																																																																																																							

## REVISION HISTORY

Edition	Document number	Prepared date	Revision contents and writer																																																																																																																																								
3rd edition	DOD - M - 0625	Sep. 18, 2001	<p><b>Revision contents</b></p> <ul style="list-style-type: none"> <li>• Change part (Before-2nd edition → After-3rd edition)</li> </ul> <p><b>(1) page 8/35</b>            4.2 ABSOLUTE MAXIMUM RATINGS            VBLH    TBD    Vrms            VBLC    TBD    Vrms            →  <b>page 8/37</b>            4.2 ABSOLUTE MAXIMUM RATINGS            VBLH    1,500    Vrms            VBLC    42.4    Vrms</p> <p><b>(2) page 9/35</b>            4.3.1 Driving for LCD panel signal processing board</p> <table border="1" style="width: 100%; border-collapse: collapse;"> <thead> <tr> <th>Parameter</th> <th>Symbol</th> <th>Min.</th> <th>Typ.</th> <th>Max.</th> <th>Unit</th> <th>Remarks</th> </tr> </thead> <tbody> <tr> <td>Supply voltage</td> <td>VCC</td> <td>3.0</td> <td>3.3</td> <td>3.6</td> <td>V</td> <td>-</td> </tr> <tr> <td>Supply current</td> <td>ICC</td> <td>-</td> <td>180 Note1</td> <td>250</td> <td>mA</td> <td>VCC = 3.3V</td> </tr> <tr> <td rowspan="2">Logic input voltage for display signals</td> <td>Low</td> <td>ViDLL</td> <td>0</td> <td>-</td> <td>0.3Vcc</td> <td rowspan="2">CMOS level</td> </tr> <tr> <td>High</td> <td>ViDLH</td> <td>0.7Vcc</td> <td>-</td> <td>Vcc</td> </tr> <tr> <td rowspan="2">Input voltage for DPSH or DPSV signals</td> <td>Low</td> <td>ViFDL</td> <td>0</td> <td>-</td> <td>0.3Vcc</td> <td rowspan="2">-</td> </tr> <tr> <td>High</td> <td>ViFDH</td> <td>0.7Vcc</td> <td>-</td> <td>Vcc</td> </tr> <tr> <td rowspan="2">Input voltage for PNS signal</td> <td>Low</td> <td>ViFPL</td> <td>0</td> <td>-</td> <td>0.3Vcc</td> <td rowspan="2">-</td> </tr> <tr> <td>High</td> <td>ViFPH</td> <td>0.7Vcc</td> <td>-</td> <td>Vcc</td> </tr> </tbody> </table> <p>→  <b>page 9/37</b>            4.3.1 Driving for LCD panel signal processing board</p> <table border="1" style="width: 100%; border-collapse: collapse;"> <thead> <tr> <th>Parameter</th> <th>Symbol</th> <th>Min.</th> <th>Typ.</th> <th>Max.</th> <th>Unit</th> <th>Remarks</th> </tr> </thead> <tbody> <tr> <td rowspan="2">Supply voltage</td> <td rowspan="2">VCC</td> <td>3.0</td> <td>3.3</td> <td>3.6</td> <td rowspan="2">V</td> <td>for 3V system</td> </tr> <tr> <td>4.7</td> <td>5.0</td> <td>5.3</td> <td>for 5V system</td> </tr> <tr> <td rowspan="2">Supply current</td> <td rowspan="2">ICC</td> <td>-</td> <td>180 Note1</td> <td>250</td> <td rowspan="2">mA</td> <td>VCC = 3.3V</td> </tr> <tr> <td>-</td> <td>120 Note1</td> <td>165</td> <td>VCC = 5.0V</td> </tr> <tr> <td rowspan="2">Logic input voltage for display signals</td> <td>Low</td> <td>VDLL</td> <td>0</td> <td>-</td> <td>0.3Vcc</td> <td rowspan="2">CMOS level</td> </tr> <tr> <td>High</td> <td>VDLH</td> <td>0.7Vcc</td> <td>-</td> <td>Vcc</td> </tr> <tr> <td rowspan="2">Input voltage for DPSH or DPSV signals</td> <td>Low</td> <td>VFDL</td> <td>0</td> <td>-</td> <td>0.3Vcc</td> <td rowspan="2">-</td> </tr> <tr> <td>High</td> <td>VFDH</td> <td>0.7Vcc</td> <td>-</td> <td>Vcc</td> </tr> <tr> <td rowspan="2">Input voltage for PNS signal</td> <td>Low</td> <td>VFPL</td> <td>0</td> <td>-</td> <td>0.3Vcc</td> <td rowspan="2">-</td> </tr> <tr> <td>High</td> <td>VFPH</td> <td>0.7Vcc</td> <td>-</td> <td>Vcc</td> </tr> </tbody> </table> <p><b>(3) page 10/35</b>            4.3.4 Fuses</p> <table border="1" style="width: 100%; border-collapse: collapse;"> <thead> <tr> <th colspan="2">Fuse</th> <th rowspan="2">Rating Note1</th> <th rowspan="2">Unit</th> <th rowspan="2">Remarks</th> </tr> <tr> <th>Type</th> <th>Supplier</th> </tr> </thead> <tbody> <tr> <td rowspan="2" style="text-align: center;">ICP-S1.8</td> <td rowspan="2" style="text-align: center;">ROHM Co., Ltd.</td> <td style="text-align: center;">1.8</td> <td style="text-align: center;">A</td> <td rowspan="2" style="text-align: center;">VCC (for LCD panel signal processing board)</td> </tr> <tr> <td style="text-align: center;">50</td> <td style="text-align: center;">V</td> </tr> </tbody> </table> <p>Note1: The power capacity should be more than twice of fuse current ratings. If the power capacity is less than the criteria value, the fuse may not blow, and then nasty smell, smoking and so on may occur.</p> <p style="text-align: center;"><i>(This part continues to the next page.)</i></p>	Parameter	Symbol	Min.	Typ.	Max.	Unit	Remarks	Supply voltage	VCC	3.0	3.3	3.6	V	-	Supply current	ICC	-	180 Note1	250	mA	VCC = 3.3V	Logic input voltage for display signals	Low	ViDLL	0	-	0.3Vcc	CMOS level	High	ViDLH	0.7Vcc	-	Vcc	Input voltage for DPSH or DPSV signals	Low	ViFDL	0	-	0.3Vcc	-	High	ViFDH	0.7Vcc	-	Vcc	Input voltage for PNS signal	Low	ViFPL	0	-	0.3Vcc	-	High	ViFPH	0.7Vcc	-	Vcc	Parameter	Symbol	Min.	Typ.	Max.	Unit	Remarks	Supply voltage	VCC	3.0	3.3	3.6	V	for 3V system	4.7	5.0	5.3	for 5V system	Supply current	ICC	-	180 Note1	250	mA	VCC = 3.3V	-	120 Note1	165	VCC = 5.0V	Logic input voltage for display signals	Low	VDLL	0	-	0.3Vcc	CMOS level	High	VDLH	0.7Vcc	-	Vcc	Input voltage for DPSH or DPSV signals	Low	VFDL	0	-	0.3Vcc	-	High	VFDH	0.7Vcc	-	Vcc	Input voltage for PNS signal	Low	VFPL	0	-	0.3Vcc	-	High	VFPH	0.7Vcc	-	Vcc	Fuse		Rating Note1	Unit	Remarks	Type	Supplier	ICP-S1.8	ROHM Co., Ltd.	1.8	A	VCC (for LCD panel signal processing board)	50	V
Parameter	Symbol	Min.	Typ.	Max.	Unit	Remarks																																																																																																																																					
Supply voltage	VCC	3.0	3.3	3.6	V	-																																																																																																																																					
Supply current	ICC	-	180 Note1	250	mA	VCC = 3.3V																																																																																																																																					
Logic input voltage for display signals	Low	ViDLL	0	-	0.3Vcc	CMOS level																																																																																																																																					
	High	ViDLH	0.7Vcc	-	Vcc																																																																																																																																						
Input voltage for DPSH or DPSV signals	Low	ViFDL	0	-	0.3Vcc	-																																																																																																																																					
	High	ViFDH	0.7Vcc	-	Vcc																																																																																																																																						
Input voltage for PNS signal	Low	ViFPL	0	-	0.3Vcc	-																																																																																																																																					
	High	ViFPH	0.7Vcc	-	Vcc																																																																																																																																						
Parameter	Symbol	Min.	Typ.	Max.	Unit	Remarks																																																																																																																																					
Supply voltage	VCC	3.0	3.3	3.6	V	for 3V system																																																																																																																																					
		4.7	5.0	5.3		for 5V system																																																																																																																																					
Supply current	ICC	-	180 Note1	250	mA	VCC = 3.3V																																																																																																																																					
		-	120 Note1	165		VCC = 5.0V																																																																																																																																					
Logic input voltage for display signals	Low	VDLL	0	-	0.3Vcc	CMOS level																																																																																																																																					
	High	VDLH	0.7Vcc	-	Vcc																																																																																																																																						
Input voltage for DPSH or DPSV signals	Low	VFDL	0	-	0.3Vcc	-																																																																																																																																					
	High	VFDH	0.7Vcc	-	Vcc																																																																																																																																						
Input voltage for PNS signal	Low	VFPL	0	-	0.3Vcc	-																																																																																																																																					
	High	VFPH	0.7Vcc	-	Vcc																																																																																																																																						
Fuse		Rating Note1	Unit	Remarks																																																																																																																																							
Type	Supplier																																																																																																																																										
ICP-S1.8	ROHM Co., Ltd.	1.8	A	VCC (for LCD panel signal processing board)																																																																																																																																							
		50	V																																																																																																																																								

## REVISION HISTORY

Edition	Document number	Prepared date	Revision contents and writer																	
3rd edition	DOD - M - 0625	Sep. 18, 2001	<p data-bbox="708 439 1193 470"><i>(This part continues from the front page.)</i></p> <p data-bbox="639 479 778 533">→ <i>page 10/37</i></p> <p data-bbox="647 539 770 566">4.3.4 Fuses</p> <table border="1" data-bbox="657 571 1485 707"> <thead> <tr> <th data-bbox="657 571 837 622" rowspan="2">Fusing line</th> <th colspan="2" data-bbox="837 571 1193 598">Fuse</th> <th data-bbox="1193 571 1273 622" rowspan="2">Rating</th> <th data-bbox="1273 571 1337 622" rowspan="2">Unit</th> <th data-bbox="1337 571 1485 622" rowspan="2">Remark</th> </tr> <tr> <th data-bbox="837 598 1018 622">Type</th> <th data-bbox="1018 598 1193 622">Supplier</th> </tr> </thead> <tbody> <tr> <td data-bbox="657 622 837 707" rowspan="2">VCC</td> <td data-bbox="837 622 1018 707" rowspan="2">ICP-S1.8</td> <td data-bbox="1018 622 1193 707" rowspan="2">ROHM Co., Ltd.</td> <td data-bbox="1193 622 1273 667">4.0</td> <td data-bbox="1273 622 1337 667">A</td> <td data-bbox="1337 622 1485 667">Note1, Note2</td> </tr> <tr> <td data-bbox="1193 667 1273 707">50</td> <td data-bbox="1273 667 1337 707">V</td> <td data-bbox="1337 667 1485 707">-</td> </tr> </tbody> </table> <p data-bbox="668 719 1038 745">Note1: This current rating is a fusing current.</p> <p data-bbox="671 752 1490 846">Note2: The power capacity should be more than the fusing current rating. If the power capacity is less than the criteria value, the fuse may not blow, and then nasty smell, smoking and so on may occur.</p> <p data-bbox="579 880 815 909"><b>Signature of writer</b></p> <p data-bbox="603 938 719 965">Approved by</p> <p data-bbox="647 972 820 1016"></p> <p data-bbox="699 1032 783 1059">T. ITO</p> <p data-bbox="890 938 991 965">Checked by</p> <p data-bbox="895 992 1139 1016">_____</p> <p data-bbox="1193 938 1294 965">Prepared by</p> <p data-bbox="1235 992 1437 1016"></p> <p data-bbox="1257 1032 1406 1059">A. SAWADA</p>	Fusing line	Fuse		Rating	Unit	Remark	Type	Supplier	VCC	ICP-S1.8	ROHM Co., Ltd.	4.0	A	Note1, Note2	50	V	-
Fusing line	Fuse		Rating		Unit	Remark														
	Type	Supplier																		
VCC	ICP-S1.8	ROHM Co., Ltd.	4.0	A	Note1, Note2															
			50	V	-															