

# NEC

## TFT COLOR LCD MODULE

**Type: NL10276BC28-24F**  
**36cm (14.1 Type), XGA**  
**LVDS interface (1 port)**

### SPECIFICATIONS

(First Edition)

**PRELIMINARY**

This document is preliminary. All information in this document is subject to change without prior notice.

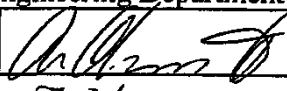
NEC Corporation NEC Electron Devices Display Device Operations Unit Color LCD Division Application Engineering Department		
Approved		Nov. 6, 2000
Checked	T. Kusumaji	Nov. 6, 2000
Prepared	n. Kano	Nov. 6, 2000

No part of this document may be copied or reproduced in any form or by any means without the prior written consent of NEC Corporation. NEC Corporation assumes no responsibility for any errors, which may appear in this document.

NEC Corporation does not assume any liability for infringement of patents, copyrights or other intellectual property rights of third parties by or arising from use of a device. No license, either express, implied or otherwise, is granted under any patents, copyrights or other intellectual property rights of NEC Corporation or others.

The devices listed in this document are for use of "Standard" applications as specified below, and are not suitable for use of "Special" or "Specific" applications as specified below. NEC disclaims any responsibility or liability of any kind for any failure of equipment, personal injury or damage to property which may arise from the use of NEC devices for such "Special" applications.

The devices listed in this documents should not be used for such "Specific" applications.

Application examples recommended by NEC Corporation.

- Standard:** Computers, office equipment, communications equipment, test and measurement equipment, audio and visual equipment, home electronic appliances, machine tools, personal electronic equipment and industrial robots.
- Special:** Transportation equipment (automobiles, trains, ships, etc.), traffic control systems, anti-disaster systems, anti-crime systems, safety equipment and medical equipment (not specifically designed for life support).
- Specific:** Military systems, aircraft, aerospace equipment, submersible repeaters, nuclear reactor control systems, life support systems or medical equipment for life support, or any other equipment for which specifically high standard of quality or reliability is required.

## CONTENTS

1. DESCRIPTION	P. 4
2. FEATURES	P. 4
3. APPLICATION	P. 4
4. STRUCTURE AND FUNCTIONS	P. 4
5. OUTLINE OF CHARACTERISTICS (at room temperature)	P. 5
6. BLOCK DIAGRAM	P. 6
7. GENERAL SPECIFICATIONS	P. 7
8. ABSOLUTE MAXIMUM RATINGS	P. 7
9. ELECTRICAL CHARACTERISTICS	P. 7
10. POWER SUPPLY SEQUENCE	P. 9
11. INTERFACE PIN CONNECTIONS	P. 9
12. METHOD OF CONNECTION FOR LVDS chip	P. 11
13. DISPLAY COLORS VS INPUT DATA SIGNALS	P. 12
14. INPUT SIGNAL TIMINGS	P. 13
15. FOR LVDS RECEIVER	P. 18
16. OPTICAL CHARACTERISTICS	P. 19
17. RELIABILITY TEST	P. 21
18. EXPECTED LIFE-TIME OF THE BARE LAMP	P. 21
19. GENERAL CAUTIONS	P. 22
20. OUTLINE DRAWINGS	P. 24
20.1 FRONT VIEW	P. 24
20.2 REAR VIEW	P. 25

## 1. DESCRIPTION

The NL10276BC28-24F is a TFT (thin film transistor) active-matrix color liquid crystal display (LCD) comprising an amorphous silicon TFT attached to each signal electrode, a driving circuit, and a backlight. NL10276BC28-24F has a built-in backlight. The 36cm(14.1 Type) diagonal display area contains  $1024 \times 768$  pixels and can display 262,144 colors simultaneously.

## 2. FEATURES

- Expanded screen size without increasing the frame area
- LVDS interface (adapted SN75LVDS88B, TEXAS INSTRUMENTS. as a receiver core with timing controller)
- High luminance (Typ.  $160 \text{ cd/m}^2$  at  $I_L = 6.0 \text{ mArms}$ )
- Supply voltage: 3.3V
- Incorporated edge-type backlight (One lamp, inverter-less)
- Approved by UL1950 (File No.E170632) Third Edition and CSA-C22.2 No.950-95 (File No.E170632)

## 3. APPLICATION

- Engineering work station, Desk-top type of PCs
- Monitors

## 4. STRUCTURE AND FUNCTIONS

A color TFT (thin film transistor) LCD module is comprised of a TFT liquid crystal panel structure, LSIs for driving the TFT array, and a backlight assembly. Sandwiching liquid crystal material in the narrow gap between a TFT array glass substrate and a color filter glass substrate creates the TFT panel structure. After the driver LSIs are connected to the panel, the backlight assembly is attached to the back side of the panel.

RGB (red, green, blue) data signals from a source system are modulated into a form suitable for active matrix addressing by the onboard signal processor and sent to the driver LSIs, which in turn address the individual TFT cells.

Acting as an Electro-optical switch, each TFT cell regulates light transmission from the backlight assembly when activated by the data source. By regulating the amount of light passing through the array of red, green, and blue dots, color images are created with clarity.

### 5. OUTLINE OF CHARACTERISTICS (at room temperature)

Display area	285.696 (H) × 214.272 (V) mm	
Drive system	a-Si TFT active matrix	
Display colors	262,144 colors	
Number of pixels	1024 × 768	
Pixel arrangement	RGB vertical stripe	
Pixel pitch	0.279 (H) × 0.279 (V) mm	
Module size	298.5 (H) × 226.5 (V) × 6.0 (D) mm Max.	
Weight	540 g (Typ.)	
Contrast ratio	250:1 (Typ.)	
Viewing angle (more than the contrast ratio of 10:1)	<ul style="list-style-type: none"> <li>· Horizontal: 40° (Typ. , left side, right side)</li> <li>· Vertical: 20° (Typ. , up side), 40° (Typ., down side)</li> </ul>	
Designed viewing direction	<ul style="list-style-type: none"> <li>· Optimum grayscale (<math>\gamma</math> =TBD): 5° (down side, 6 o'clock)</li> <li>· Best contrast angle: down side</li> </ul>	
Pencil hardness	3 H (Min., JIS K5400)	
Color gamut	40 % (Typ., At center, To NTSC)	
Response time	15 ms (Max.), white to black (100%→10%)	
Luminance	160 cd/m <sup>2</sup> (Typ. at IL= 6.0mArms)	
Signal system	LVDS interface (Receiver:SN75LVDS88B, TEXAS INSTRUMENTS.) RGB 6-bit signals, Synchronous signals (Hsync, Vsync), Data enable signal (DE) and dot clock (CLK) encoded with SN75LVDS84A (TEXAS INSTRUMENTS.) are preferable.	
Supply voltage	3.3 V (Typ.)	
Backlight	Edge light type: One cold cathode fluorescent lamp in a holder, Inverter-less	
Power consumption	5.2 W (Typ. at 160 cd/m <sup>2</sup> )	

6. BLOCK DIAGRAM

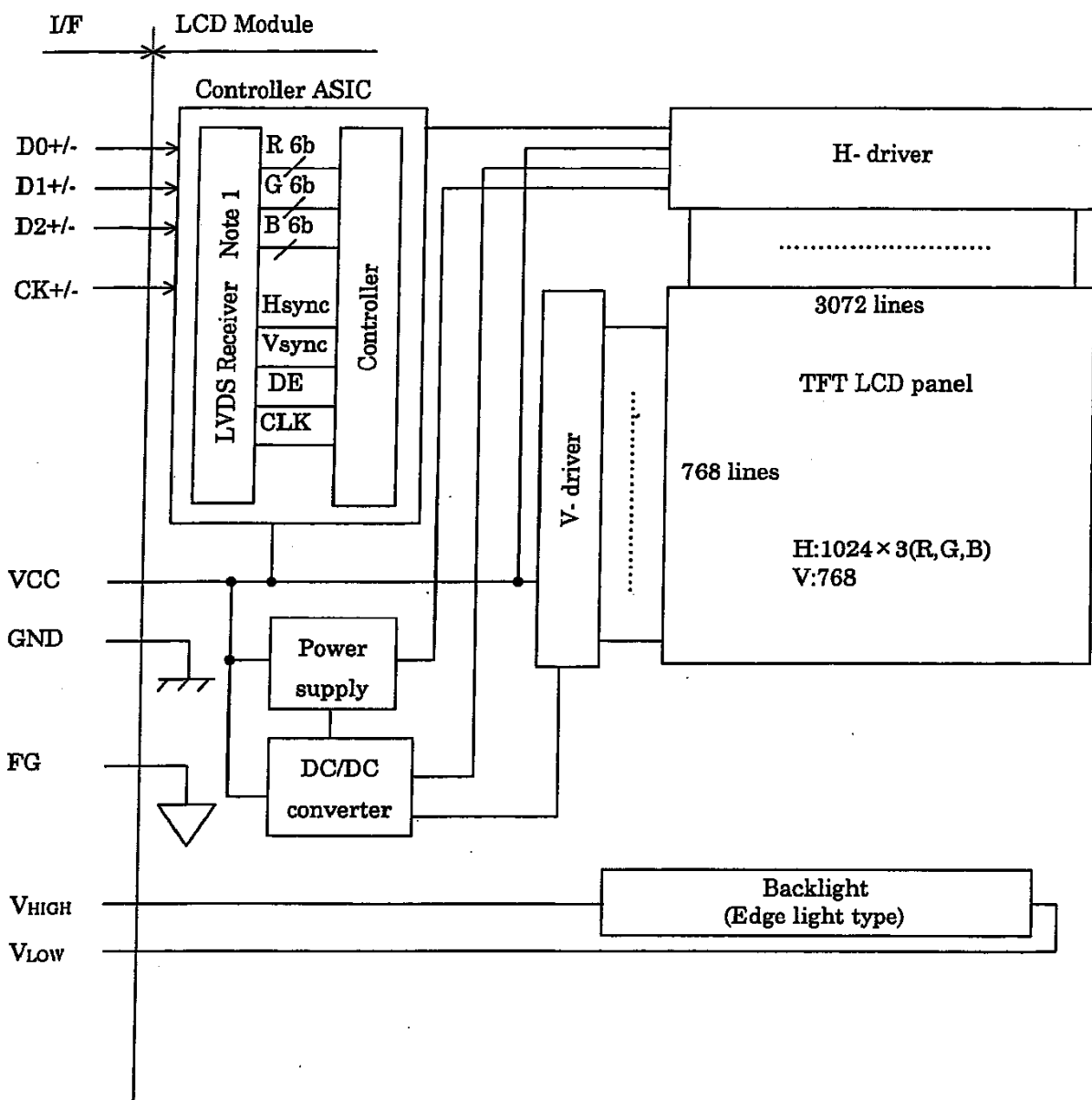

Note 1: SN75LVDS88B (TEXAS INSTRUMENTS.)

Remark 1: GND is connected to the FG (Frame ground) in the LCD module.

## 7. GENERAL SPECIFICATIONS

Items	Specifications	Unit
Module size	298.5±0.5 (H) × 226.5±0.5 (V) × 6.0 (D) Max.	mm
Display area	285.696 (H) × 214.272 (V) 【 Diagonal display area: 36cm (Type: 14.1) 】	mm
Number of pixels	1024 (H) × 768 (V)	pixel
Dot pitch	0.093 (H) × 0.279 (V)	mm
Pixel pitch	0.279 (H) × 0.279 (V)	mm
Pixel arrangement	RGB (red, green, blue) vertical stripe	—
Display colors	262,144 (RGB 6-bit each)	color
Weight	570 (Max.)	g

## 8. ABSOLUTE MAXIMUM RATINGS

Parameters	Symbols	Ratings	Unit	Remarks
Supply voltage	VCC	-0.3 to +4.0	V	Ta = 25°C
Logic input voltage	VI	-0.3 to VCC+0.3	V	
Lamp voltage	VL	2000	Vrms	
Storage temperature	Tst	-20 to +60	°C	—
Operating temperature	Top	0 to +50	°C	Module surface Note 1
Relative humidity (RH)	Note 2	≤ 95	%	Ta ≤ 40°C
		≤ 85	%	40°C < Ta ≤ 50°C
Absolute humidity	Note 2	Absolute humidity shall not exceed Ta=50°C, RH= 85%.		Ta > 50°C

Note 1: Measured at the display area (including self-heat)

Note 2: No condensation

## 9. ELECTRICAL CHARACTERISTICS

## (1) Logic/ LCD driving

Ta = 25°C

Parameters	Symbols	Min.	Typ.	Max.	Unit	Remarks
Supply voltage	VCC	3.0	3.3	3.6	V	—
Ripple voltage	VRP	—	—	100	mV	for VCC
LVDS signal input “L” voltage	VTL	-100	—	—	mV	VCM=1.2V
LVDS signal input “H” voltage	VTH	—	—	+100	mV	VCM: Common mode voltage in LVDS driver
Terminating resistor	RT	—	100	—	Ω	—
Supply current	ICC	—	320 Note 1	650 Note 2	mA	VCC= 3.3V

Note 1: Checker flag pattern (in EIAJ ED-2522)

Note 2: 2H1V Checker flag pattern

## (2) Backlight

Ta = 25°C

Parameters	Symbols	Min.	Typ.	Max.	Unit	Remarks
Lamp current	IL	2.0	6.0	6.0	mArms	IL=6.0 mArms 160 cd/m <sup>2</sup> Note1
Lamp voltage	VL	—	690	—	Vrms	IL=6.0 mArms
Lamp turn on voltage	VS	1300	—	—	Vrms	Ta=0°C Note1
		900	—	—		Ta=25°C Note1
Oscillator frequency	Ft	50	60	—	kHz	Note2

Note1: When IL and VS are less than Min. value, lamps might be not turned on it.

Note2: Recommended value of "Ft"

•Ft is within the specification.

$$F_t = \frac{1}{4th} \times (2n-1) \quad \begin{array}{l} th: \text{Hsync period} \\ n: \text{a natural number (1,2,3,\dots)} \end{array}$$

If Ft is out of the recommended value, interference between Ft frequency and Hsync frequency may cause beat on the display.



## 10. POWER SUPPLY SEQUENCE

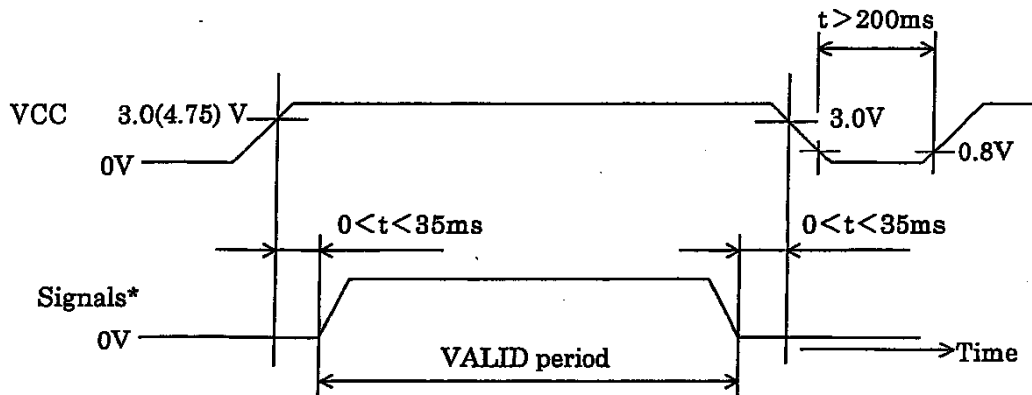

\*Signals: CLK, Hsync, Vsync, DE, R0-R5, G0-G5, B0-B5

Note 1: The supply voltage for input signals should be the same as VCC.

Note 2: Turn on the backlight within the LCD operation period. When the backlight turns on before LCD operation or the LCD operation turns off before the backlight turns off, the display may momentarily become white.

Note 3: When the power is off, keep whole signals (CLK, Hsync, Vsync, DE, R0-R5, G0-G5, and B0-B5) low level or high impedance.

Note 4: Wrong power sequence may damage the module.

Note 5: The signals should not be down during operation. Even if the signals could recover, the LCD module can not be operated correctly or the display may have un-uniformity. In case the signals is down, VCC should be turned off, and then turn VCC and the signals on with above sequence.

## 11. INTERFACE PIN CONNECTIONS

(1) Interface connector for signals and power

Part No.: FI-SEB20P-HF10

Adaptable plug: FI-SE20S

Supplier: Japan Aviation Electronics Industry Limited (JAE)

### CN1 socket

Pin No.	Symbols	Signal type	Functions
1	VCC	Power supply	Supply +3.3V $\pm$ 0.3V
2	VCC		
3	GND	Ground	Note 1
4	GND		
5	D0-	Pixel data etc.	LVDS differential data input Note 2
6	D0+		
7	GND	Ground	Note 1
8	D1-	Pixel data etc.	LVDS differential data input Note 2
9	D1+		
10	GND	Ground	Note 1
11	D2-	Pixel data etc.	LVDS differential data input Note 2
12	D2+		
13	GND	Ground	Note 1
14	CK-	Pixel clock	CLK for pixel data $f=65\text{MHz}$ (Typ.) (LVDS level) Note 2
15	CK+		
16	GND	Ground	Note 1
17	N.C.	Non-connection	-
18	N.C.		
19	GND	Ground	Note 1
20	GND		

Note 1: GND for logic and LCD driving. GND is not connected to FG (Frame Ground) in the module.  
These grounds should be connected in customer equipment.

Note 2: Use 100 $\Omega$  twist pair wires for the cable.

Remark: Do not keep pins free (except 17 and 18) to avoid noise issue.

CN1 socket: Figure from socket view

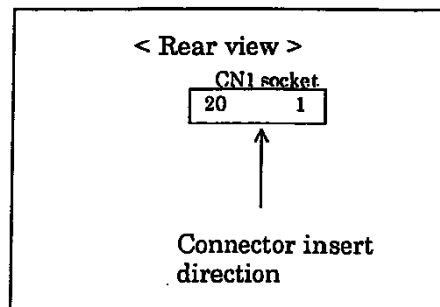

(2) Connector for backlight unit

Part No.: BHTR-02VS-1  
 Adaptable socket: BHTMR-02VS  
 Supplier: J.S.T. TRADING Company, Ltd.

CN2

Pin No.	Symbols	Functions
1	V <sub>HIGH</sub>	High voltage terminal
2	V <sub>LOW</sub>	Low voltage terminal

Note1: V<sub>HIGH</sub> and V<sub>LOW</sub> must be connected correctly. If you connect wrongly, you will get hurt and the module will be broken.

12. METHOD OF CONNECTION FOR LVDS chip

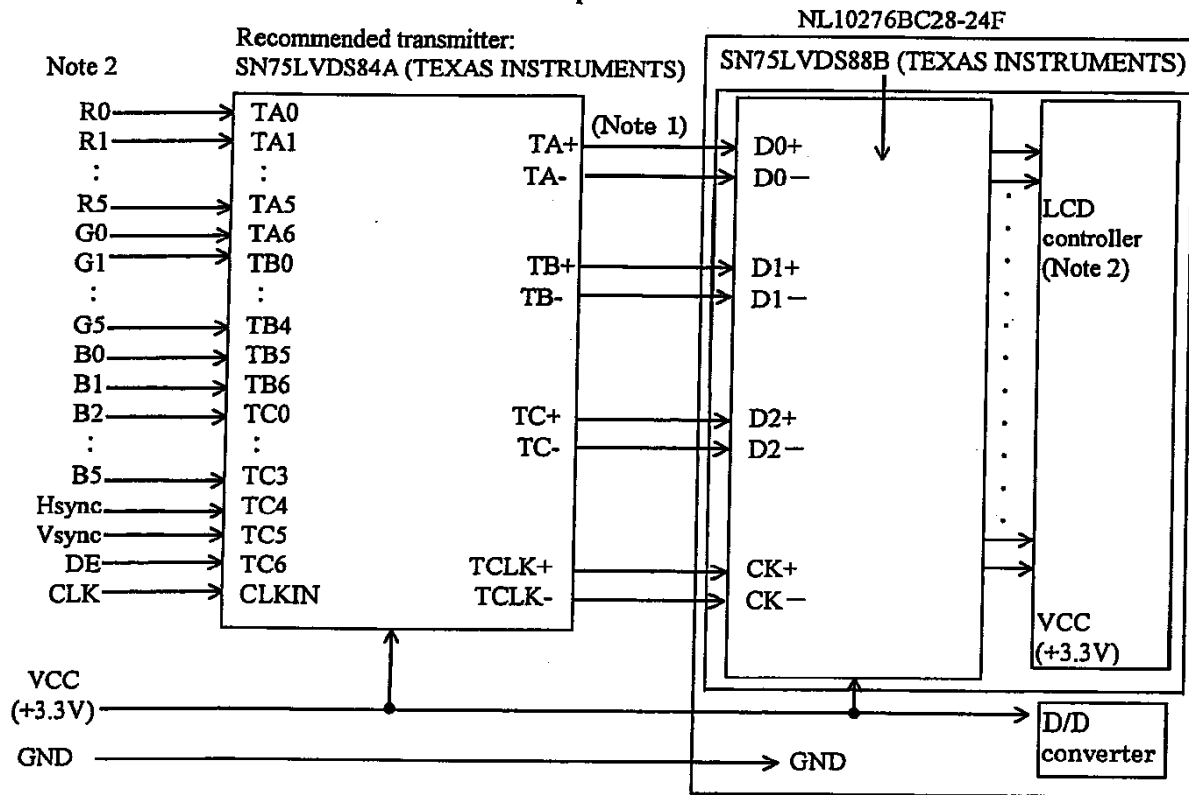

Note 1: 100 Ω twist pair

Note 2: These signals should be kept in the specified range of 14. INPUT SIGNAL TIMINGS.

13. DISPLAY COLORS vs INPUT DATA SIGNALS

Display colors		Data signal(0: Low level, 1: High level)																	
		R5	R4	R3	R2	R1	R0	G5	G4	G3	G2	G1	G0	B5	B4	B3	B2	B1	B0
Basic colors	Black	0	0	0	0	0	0	0	0	0	0	0	0	0	0	0	0	0	0
	Blue	0	0	0	0	0	0	0	0	0	0	0	0	1	1	1	1	1	1
	Red	1	1	1	1	1	1	0	0	0	0	0	0	0	0	0	0	0	0
	Magenta	1	1	1	1	1	1	0	0	0	0	0	0	1	1	1	1	1	1
	Green	0	0	0	0	0	0	1	1	1	1	1	1	0	0	0	0	0	0
	Cyan	0	0	0	0	0	0	1	1	1	1	1	1	1	1	1	1	1	1
	Yellow	1	1	1	1	1	1	1	1	1	1	1	1	0	0	0	0	0	0
	White	1	1	1	1	1	1	1	1	1	1	1	1	1	1	1	1	1	1
Red grayscale	Black	0	0	0	0	0	0	0	0	0	0	0	0	0	0	0	0	0	0
	dark	0	0	0	0	0	1	0	0	0	0	0	0	0	0	0	0	0	0
	↑																		
	↓																		
	bright	1	1	1	1	0	1	0	0	0	0	0	0	0	0	0	0	0	0
Green grayscale	Black	0	0	0	0	0	0	0	0	0	0	0	0	0	0	0	0	0	0
	dark	0	0	0	0	0	0	0	0	0	0	0	1	0	0	0	0	0	0
	↑																		
	↓																		
	bright	0	0	0	0	0	0	1	1	1	1	0	1	0	0	0	0	0	0
Blue grayscale	Black	0	0	0	0	0	0	0	0	0	0	0	0	0	0	0	0	0	0
	dark	0	0	0	0	0	0	0	0	0	0	0	0	0	0	0	0	0	1
	↑																		
	↓																		
	bright	0	0	0	0	0	0	0	0	0	0	0	0	1	1	1	1	0	1
Blue	0	0	0	0	0	0	0	0	0	0	0	0	1	1	1	1	1	1	

Note 1: Colors are developed in combination with 6-bit signals (64 steps in grayscale) of each primary red, green, and blue color. This process can result in up to 262,144 (64 × 64 × 64) colors.

## 14. INPUT SIGNAL TIMINGS

(1) Input signal specifications for LCD controller

	Parameters	Symbols	Min.	Typ.	Max.	Unit	Remarks	
CLK	Frequency	1/tc	60.0	65.0	68.0	MHz	15.384ns (Typ.)	
	Duty	tch/tc	Note1			—	—	
	Rise, fall	terf				ns		
Hsync	Period	th	20.676			$\mu$ s	48.363kHz (Typ.)	
			1344			CLK		
	Display period	thd	1024			CLK	—	
	Front-porch	thf *	1	40	—	CLK	—	
	Pulse width	thp *	2	208	—	CLK	—	
	Back-porch	thb *	1	72	—	CLK	—	
		* thf + thp + thb	81	320	1023	CLK	—	
		Hsync-CLK timing	ths	Note1			ns	—
		CLK-Hsync timing	thh				ns	
		Rise, fall	thrf				ns	
	Vsync	Period	tv	16.666			ms	60.004Hz (Typ.)
			806			H		
Display period		tvd	768			H	—	
Front-porch		tvf *	1	3	—	H	—	
Pulse width		tvp *	2	—	—	H	—	
Back-porch		tvb *	1	33	—	H	—	
		* tvf + tvp + tvb	4	38	—	H	—	
		Vsync-Hsync timing	tvhs	Note1			ns	—
		Hsync-Vsync timing	tvhs				CLK	
	Rise, fall	tvrf	ns					
			ns					
DATA	DATA-CLK (Set up)	tds	Note1			ns	—	
	CLK-DATA (Hold)	tdh				ns		
DE	DE-CLK timing	tes	Note1			ns	—	
	CLK-DE timing	teh				ns		
	Rise, fall	terf				ns		

Note 1: These values are specified at the inputs of SN75LVDS88B (TEXAS INSTRUMENTS).  
(Refer to 12. METHOD OF CONNECTION FOR LVDS chip)

## (2) Definition of input signals timing for LCD controller

&lt;Vertical&gt;

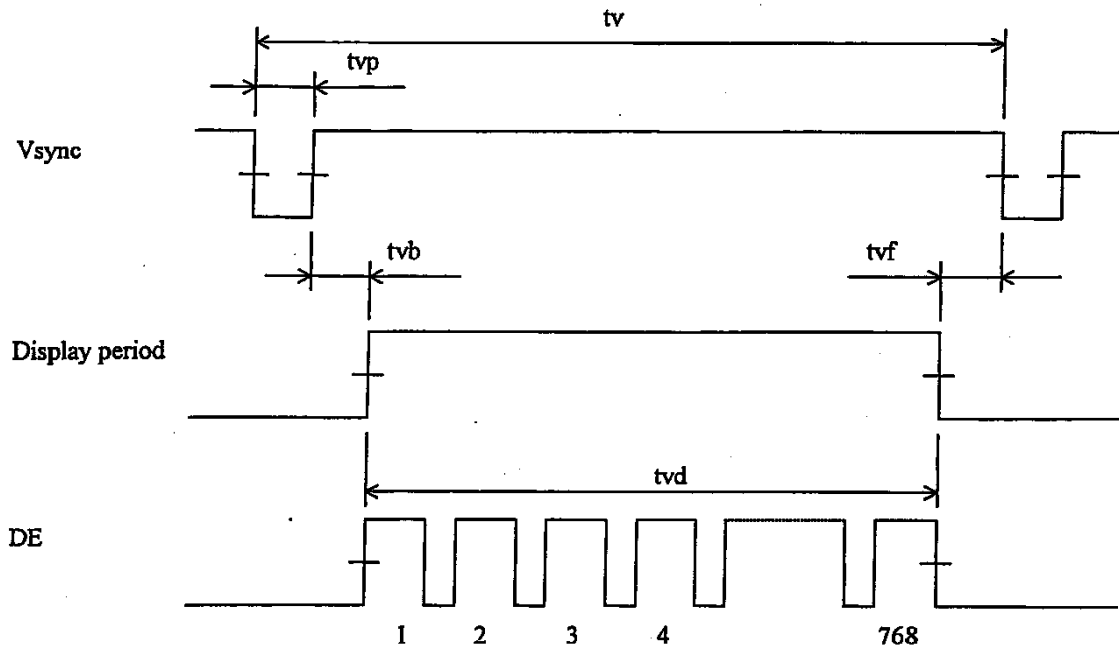

&lt;Horizontal&gt;

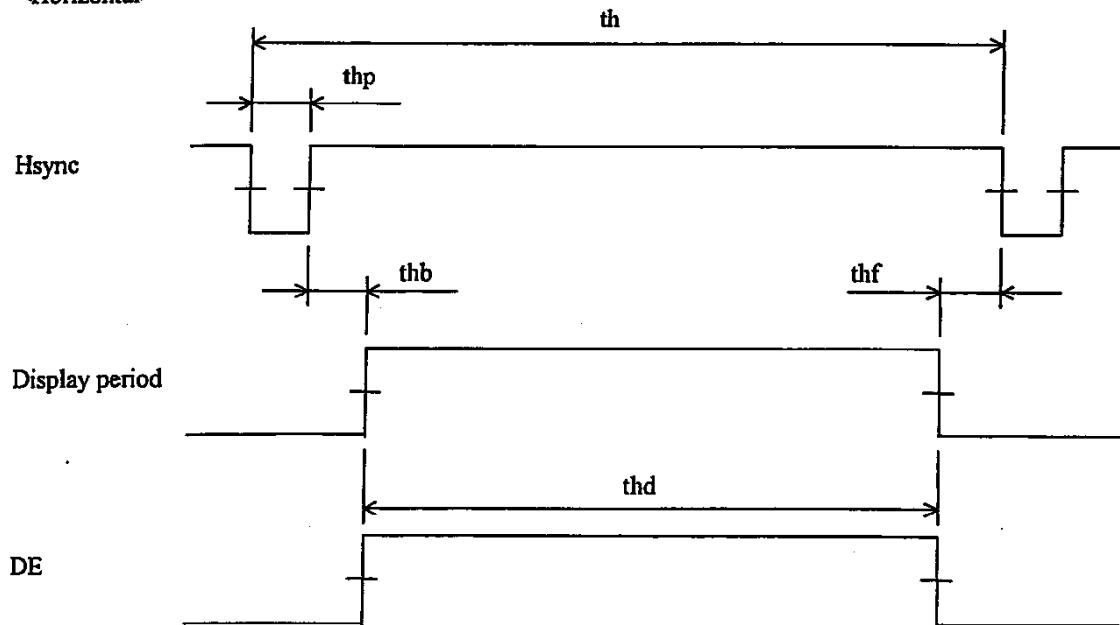

Note 1: "Display period" do not exist as signals.

Note 2: These values are specified at the inputs of SN75LVDS88B.

(Refer to 12. METHOD OF CONNECTION FOR LVDS chip)

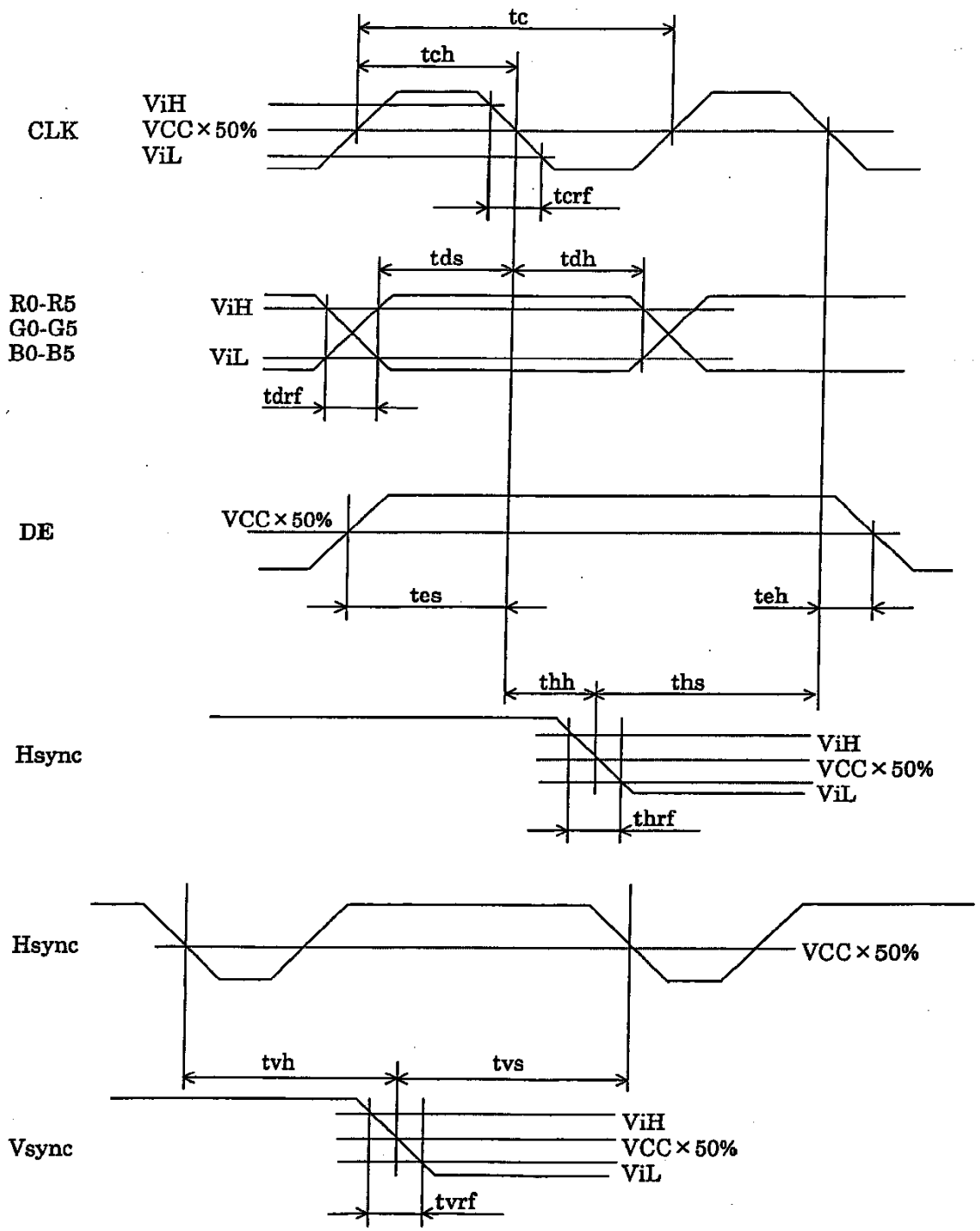

$V_{iH} = V_{CC} \times 0.7(\text{Min.})$   
 $V_{iL} = V_{CC} \times 0.3(\text{Max.})$

(3) Input signals timing chart for LCD

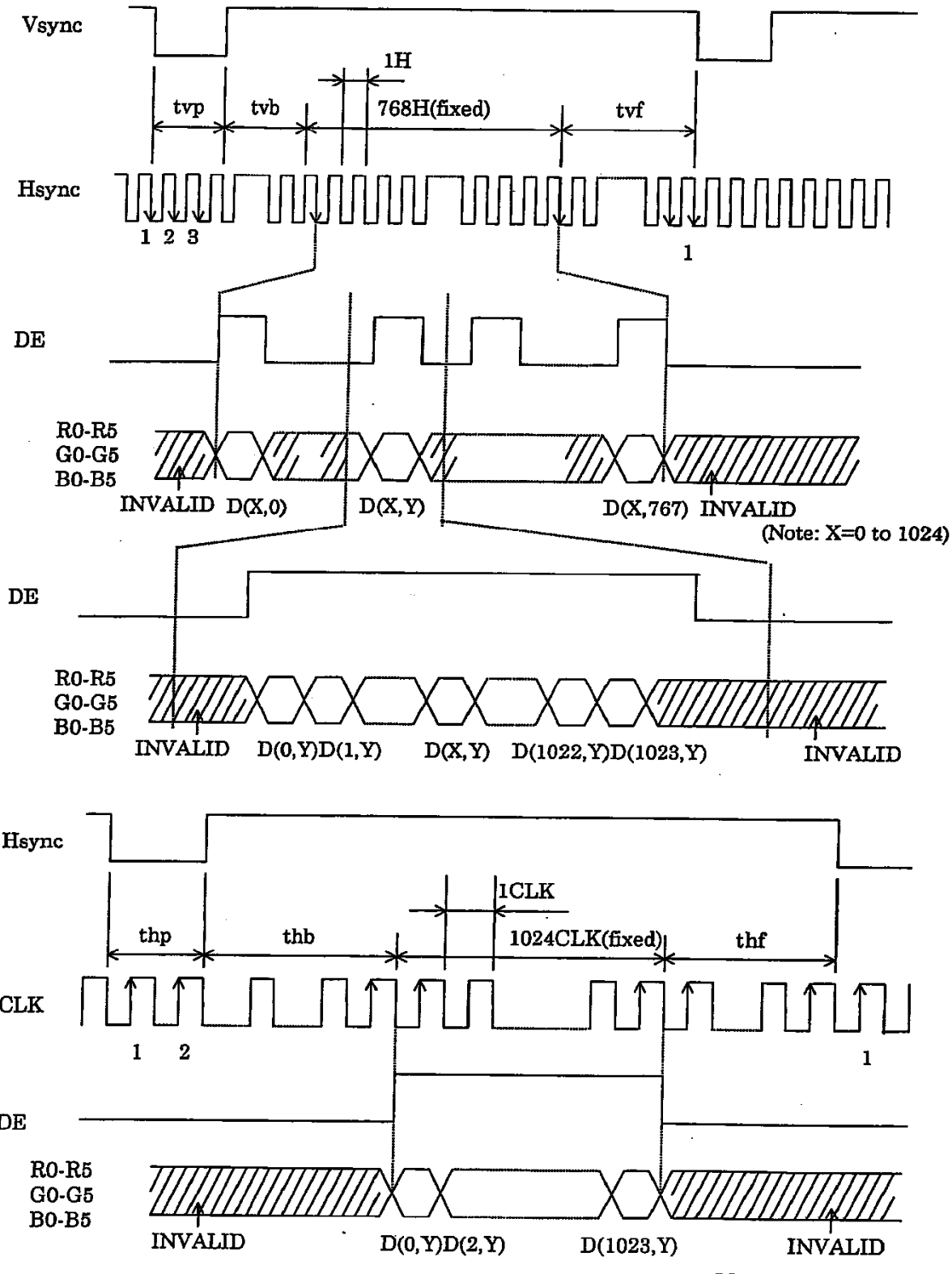

Note 1: These values are specified at the inputs of THC63LVDF63A.  
(Refer to 12. METHOD OF CONNECTION FOR LVDS chip).



## (4) Display positions of input data

D(0, 0)	D(1, 0)	...	D(X, 0)	...	D(1023, 0)
D(0, 1)	D(1, 1)	...	D(X, 1)	...	D(1023, 1)
⋮	⋮	⋮	⋮	⋮	⋮
D(0, Y)	D(1, Y)	...	D(X, Y)	...	D(1023, Y)
⋮	⋮	⋮	⋮	⋮	⋮
D(0, 767)	D(1, 767)	...	D(X, 767)	...	D(1023, 767)

15. FOR LVDS RECEIVER

(1) Input signal specifications (It is prescribed in the part CN1 input)

Parameters	Symbols	Min.	Typ.	Max.	Unit	Remarks
CLK Frequency	tRCP	14.71	15.38	16.66	ns	--
Bit0 position	tRIP1	--	0	--	ns	--
Bit1 position	tRIP0	--	T/7	--	ns	--
Bit2 position	tRIP6	--	2T/7	--	ns	--
Bit3 position	tRIP5	--	3T/7	--	ns	--
Bit4 position	tRIP4	--	4T/7	--	ns	--
Bit5 position	tRIP3	--	5T/7	--	ns	--
Bit6 position	tRIP2	--	6T/7	--	ns	--
	SKRM	490	--	--	ps	--

Note 1: See the specifications of LVDS manufactures for detailed design.

In case that CLK jitter value between current cycle and next cycle is big, skew time of the next cycle decreases with the value of the jitter.

$$\text{CLK jitter} + \text{LVDS output skew} + \text{cable skew} \leq 500\text{ps}$$

e. g. LVDS output skew:  $\pm 200\text{ps}$   
 Cable skew:  $\pm 100\text{ps}$  } acceptable CLK jitter  $\pm 200\text{ps}$  ( $500 - (200 + 100) = 200\text{ps}$ )

(2) Input signals timing chart

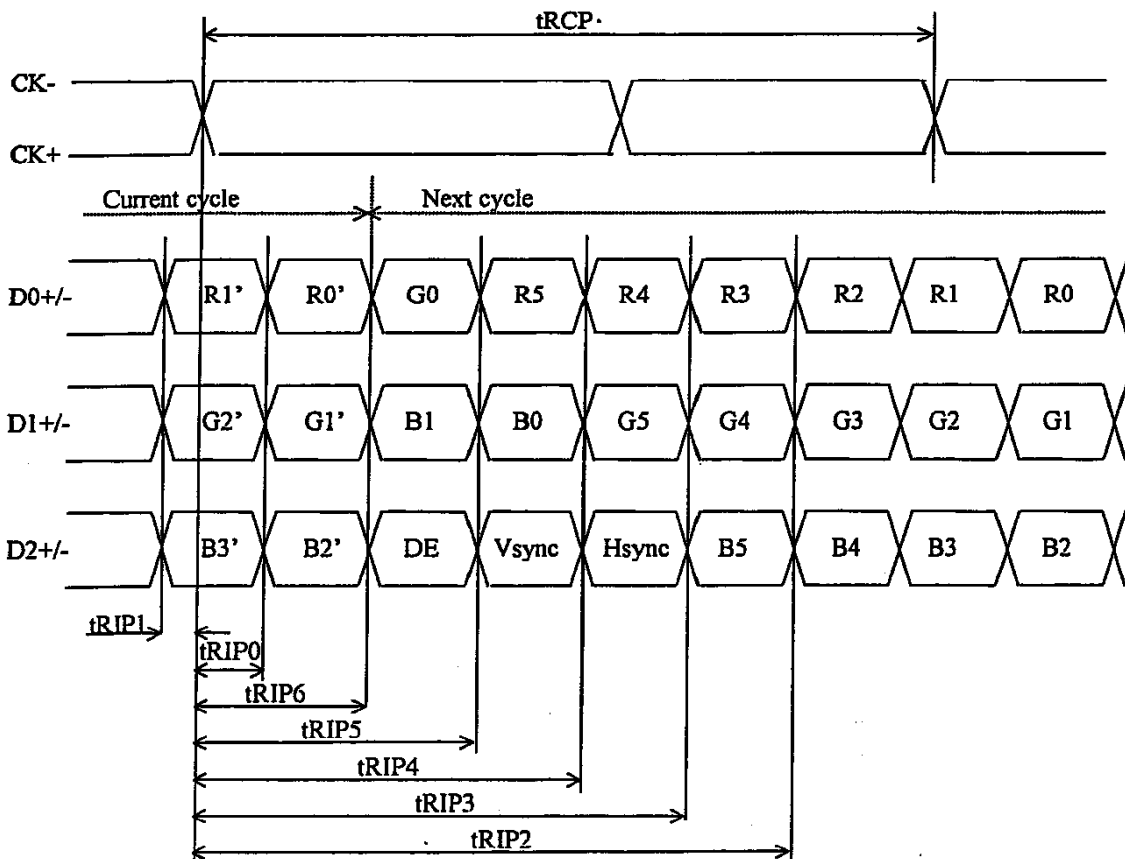

## 16. OPTICAL CHARACTERISTICS

(Ta = 25 ± 5°C, VCC = 3.3V, IL = 6.0 mA rms, Note 1)

Items	Symbols	Conditions	Min.	Typ.	Max.	Unit	Remarks
Contrast ratio	CR	$\theta_R=0^\circ, \theta_L=0^\circ, \theta_U=0^\circ, \theta_D=0^\circ$ White/Black, at center	80	250	—	—	Note 2
Luminance	Lvmax	White, at center	135	160	—	cd/m <sup>2</sup>	—
Luminance uniformity	—	White	—	—	TBD	—	Note 3

## Reference data

Items	Symbols	Conditions	Min.	Typ.	Max.	Unit	Remarks	
Best contrast ratio	CR	$\theta_R=0^\circ, \theta_L=0^\circ, \theta_U=0^\circ, \theta_D=5^\circ$	—	300	—	—	Note 2	
Viewing angle range (CR > 10)	$\theta_{x+}$	CR > 10, $\theta_U=0^\circ, \theta_D=0^\circ$ White/Black, at center	30	40	—	deg.	Note 4	
	$\theta_{x-}$	White/Black, at center	30	40	—	deg.		
	$\theta_{y+}$	CR > 10, $\theta_R=0^\circ, \theta_L=0^\circ$ White/Black, at center	10	20	—	deg.		
	$\theta_{y-}$	White/Black, at center	30	40	—	deg.		
Viewing angle range (CR > 5)	$\theta_{x+}$	CR > 5, $\theta_U=0^\circ, \theta_D=0^\circ$ White/Black, at center	—	50	—	deg.	Note 4	
	$\theta_{x-}$	White/Black, at center	—	50	—	deg.		
	$\theta_{y+}$	CR > 5, $\theta_R=0^\circ, \theta_L=0^\circ$ White/Black, at center	—	25	—	deg.		
	$\theta_{y-}$	White/Black, at center	—	50	—	deg.		
Color gamut	C	$\theta_R=0^\circ, \theta_L=0^\circ, \theta_U=0^\circ, \theta_D=0^\circ$ at center, to NTSC	35	40	—	%	—	
Response time	Ton	White to Black	(100% → 10%)	—	15	40	ms	Note 5
			(90% → 10%)	—	TBD	TBD		
	Toff	Black to White	(0% → 90%)	—	TBD	TBD	ms	
			(10% → 90%)	—	TBD	TBD		

Note 1: Optical characteristics are measured after 20 minutes from the module works.

The typical value is measured after luminance saturation, more than one hour after burn-in.  
Optical characteristics are measured in dark room.

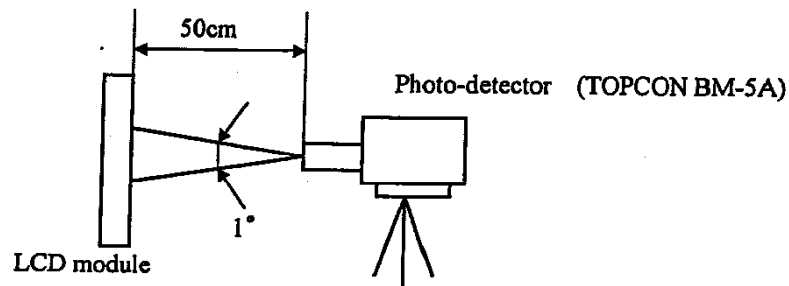

Note 2: The contrast ratio is calculated by using the following formula.

$$\text{Contrast ratio (CR)} = \frac{\text{Luminance with all pixels in "white"}}{\text{Luminance with all pixels in "black"}}$$

Note 3: Luminance uniformity is calculated by using the following formula.

$$\text{Luminance uniformity} = \frac{\text{Maximum luminance}}{\text{Minimum luminance}}$$

The luminance is measured at near the five points shown below.

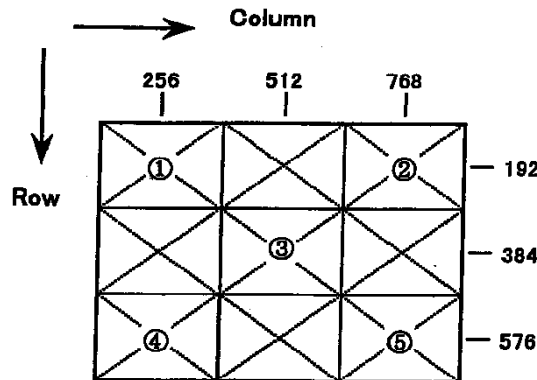

Note 4: Definitions of viewing angle are as follows.

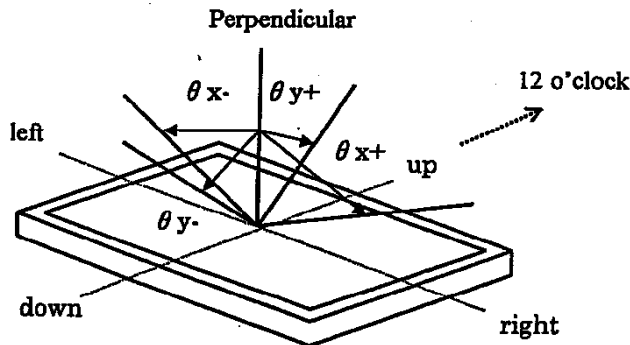

Note 5: Definition of response time is as follows.

Photo-detector output signal is measured when the luminance changes "white" to "black".

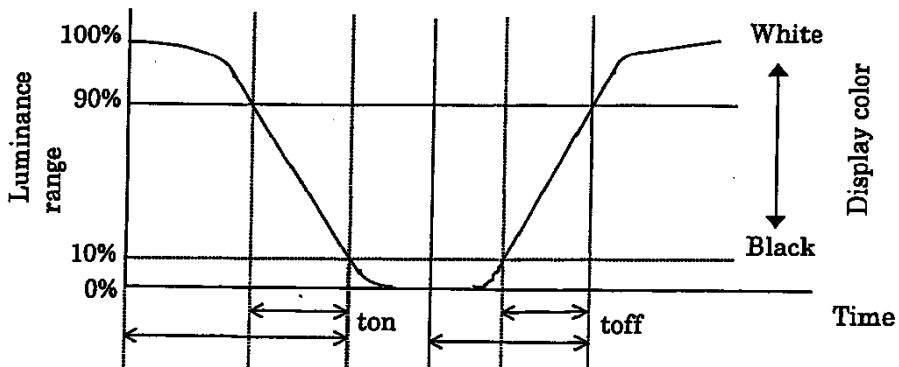

## 17. RELIABILITY TEST

Test items	Test conditions	Judgment
High temperature/humidity operation	50±2°C, RH= 85% 240 hours, Display data is white.	*1
Heat cycle (operation)	① 0°C±3°C···1 hour +55°C±3°C···1 hour ② 50 cycles, 4 hours/cycle ③ Display data is white.	*1
Thermal shock (non-operation)	① -20°C±3°C···30 minutes +60°C±3°C···30 minutes ② 100 cycles ③ Temperature transition time is within 5 minutes.	*1
Vibration (non-operation)	① 5-100Hz, 19.6m/s <sup>2</sup> (2G) 1 minute/cycle, X,Y,Z direction ② 120 times each direction	*1, *2
Mechanical shock (non-operation)	① 490m/s <sup>2</sup> (50G), 11ms X,Y,Z direction ② 5 times each direction	*1, *2
ESD (operation)	150pF, 150Ω, ±10kV 9 places on a panel *3 10 times each place at one-second intervals	*1
Dust (operation)	15 kinds of dust (JIS-Z 8901) Hourly 15 seconds stir, 8 times repeat	*1

\*1: Display function is checked by the same condition as LCD module out-going inspection.

\*2: Physical damage

\*3: Discharge points are shown in the figure.

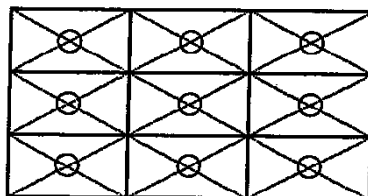

## 18. EXPECTED LIFE-TIME OF THE BARE LAMP

Note 1,3

	Bare lamp
Condition	IL=6mAmps/lamp Room temp. (25±2°C), Continuous operation
Expected value (MTTF)	10,000 h <span style="float: right;">Note 2</span>
Criteria	Half value luminance (compared with initial value.)

Note 1: The life-time is expected value (reference).

Note 2: This expected value is based on the test results with a bare lamp operation.

The MTTF for the module may be different from these values, because of the influence of ambient and clamshell conditions.

Note 3: The life-time becomes short if the module is operated under the low temperature environment.

## 19. GENERAL CAUTIONS

Because the following figures and statements are very important, please be sure you understand their contents completely.



### CAUTION

This figure is a warning that you will get hurt and/or the module will be damaged if you make a mistake in operation.



This figure is a warning that you will get hurt if you make a mistake in operation.



### CAUTIONS

#### (1) A caution when taking out the module

- ① Pick up the pouch only, when removing the module from the carrier box.

#### (2) Cautions for handling the module

- ① As the electrostatic discharges may break the LCD module, handle the LCD module with care against electrostatic discharges. Peel protection sheet out from the LCD panel surface as slowly as possible.
- ②  As the LCD panel and backlight element are made from fragile glass material, impulse and pressure to the LCD module should be avoided.
- ③ As the surface of polarizer is very soft and easily scratched, use a soft dry cloth without chemicals for cleaning.
- ④ Do not pull the interface connectors in or out while the LCD module is operating.
- ⑤ Put the module display side down on a flat horizontal plane.
- ⑥ Handle connectors and cables with care.
- ⑦ When the module is operating, do not lose CLK, Hsync, or Vsync signal. If any one or more of these signals is lost, the LCD panel would be damaged.
- ⑧ The torque for mounting screws should never exceed 0.2 N·m (2.0 kgf·cm).
- ⑨ The LCD module should be mounted in strong body such as magnesium alloy. If the press or twist are added to the module, the display may have un-uniformity image. When the module is mounted to customer chassis, please evaluate the display condition carefully.
- ⑩ Be careful not to touch the sheet at handling because only a thin transparency seat is put on the printed circuit board.

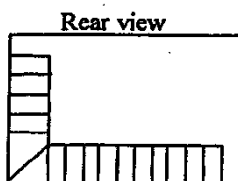

← A thin transparency sheet on the printed circuit board.

- ⑪ Do not any stress to the interface connector.

#### (3) Cautions regarding atmosphere

- ① Dew drop atmosphere must be avoided.
- ② Do not store and/or operate the LCD module in high-temperature and/or high humidity atmosphere. Storage in an Electro-conductive polymer-packing pouch and in a relatively low-temperature atmosphere is recommended.
- ③ This module uses cold cathode fluorescent lamp. The lifetime of the lamps is shortened conspicuously at low temperatures.
- ④ Do not operate the LCD module in high magnetic field.

(4) Caution about the module characteristics

- ① Do not apply any fixed pattern to the LCD module at product aging. Applying a fixed pattern for a long time may cause image sticking.

(5) Other cautions

- ① Do not disassemble and/or reassemble the LCD module.
- ② Do not readjust variable resistors nor switches etc.
- ③ When returning the module for repair etc., pack the module so it will not be broken.  
We recommend using the original shipping packages.

The liquid crystal display has the following specific characteristics. These are neither defects nor malfunctions.

The ambient temperature may affect the display condition of the LCD module.

The LCD module uses cold cathode tube for backlight. Optical characteristics, like luminance or uniformity, will change over time.

Uneven brightness and/or small spots may be noticed, depending on different display patterns.

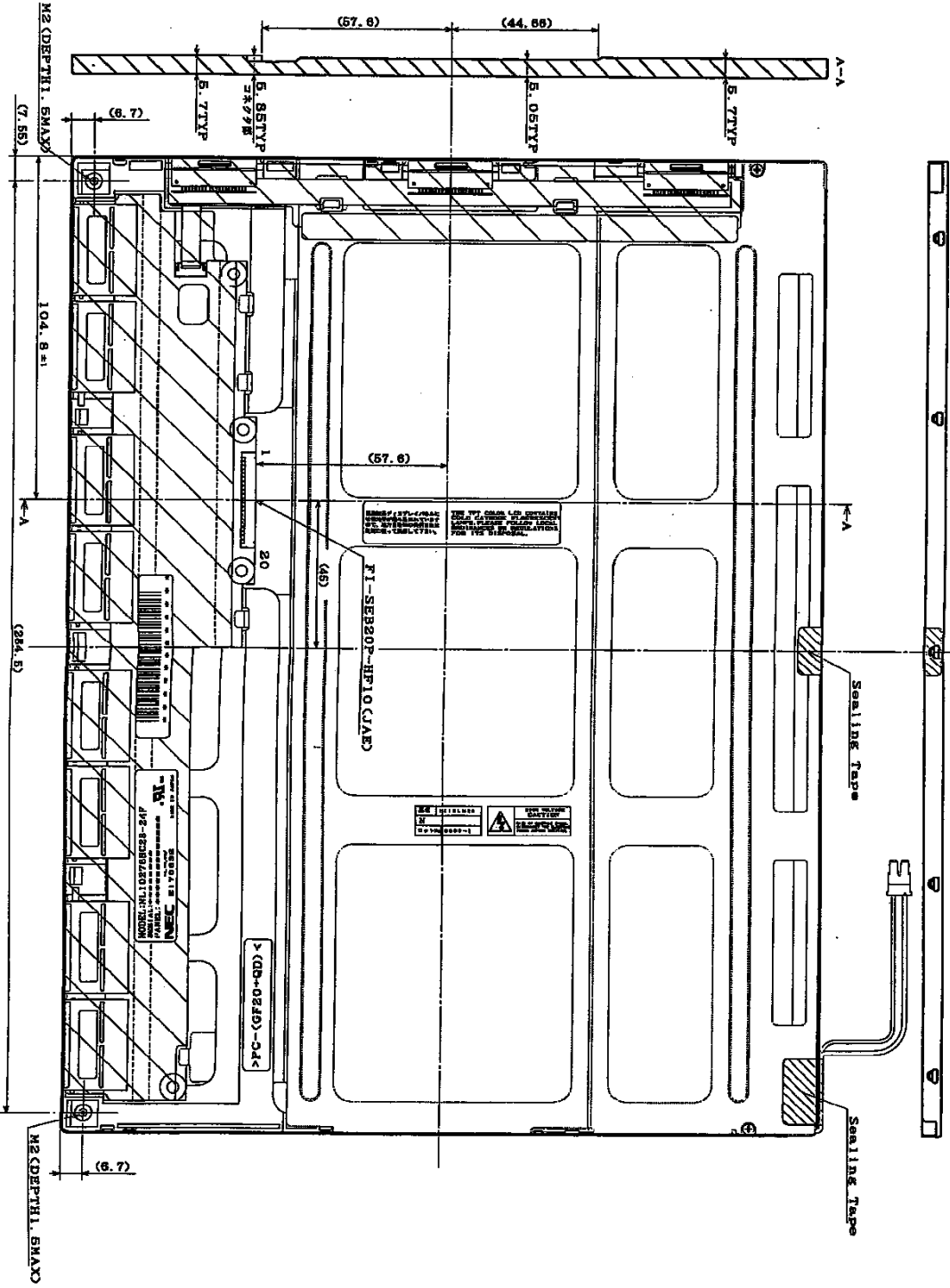



20. OUTLINE DRAWINGS (Unit: mm)  
20.1 Front view

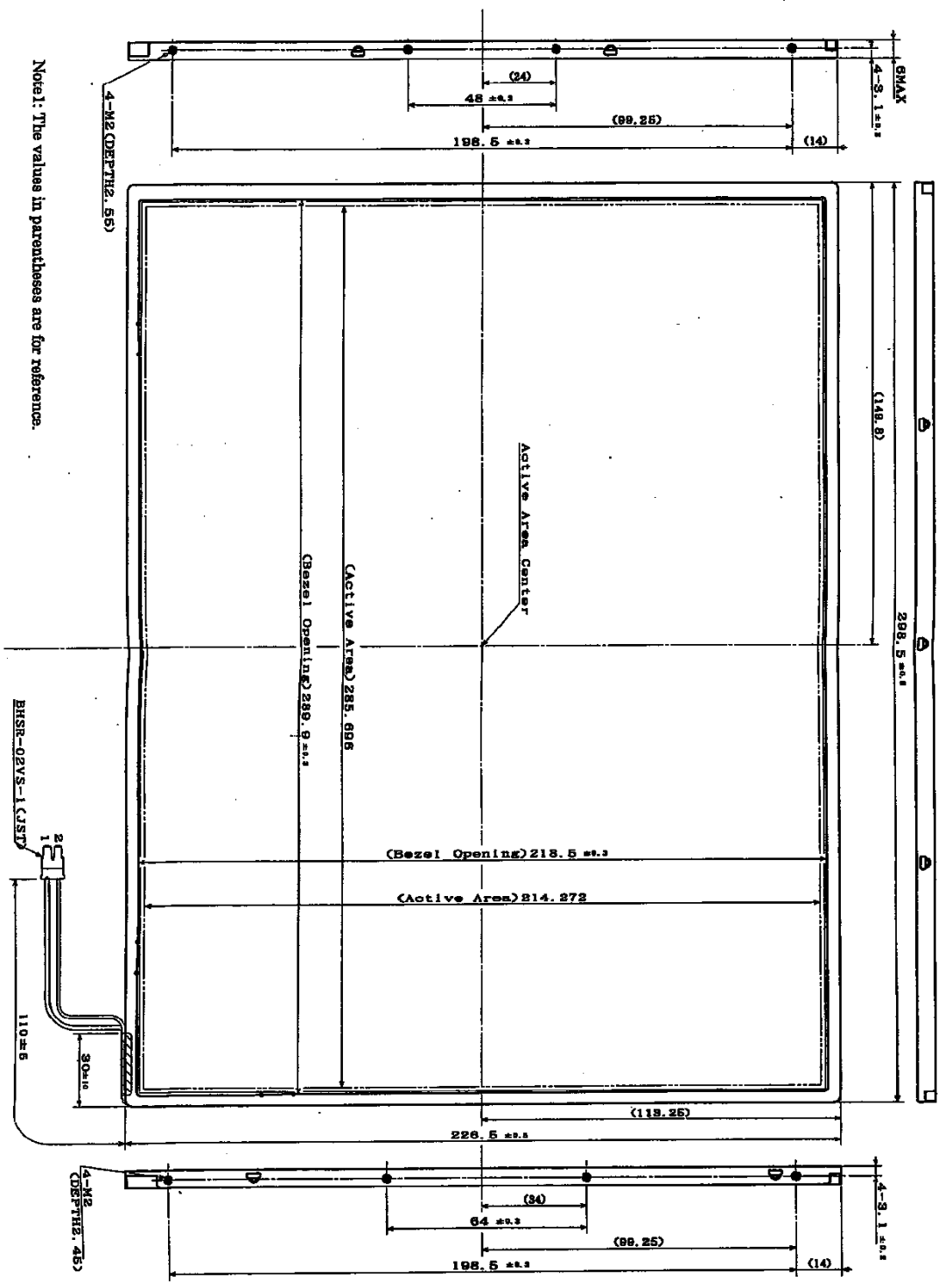

Note 1: The values in parentheses are for reference.

Revision History			DOD-H-8181		26/26	
Rev.	prepared date	Revision contents	Approved	Checked	Prepared	Issued date
1	Nov. 6, 2000	<del>           Reliability and QC department            R: _____            QA: _____            Planning Department            _____            Product Engineering Department            _____            Application Engineering Department            _____         </del>	<i>[Signature]</i>	<i>[Signature]</i>	<i>[Signature]</i>	