



ISSUED DATE : 2010-1-11

SAMSUNG TFT-LCD PRODUCT INFORMATION
MODEL : LTM230HT05

Note : This is Product Information is subject to change after 3 months of issuing date.

Application Engineering Part 1, TCS team
LCD Division, Samsung Electronics Co. , LTD.



SAMSUNG TFT-LCD

| | | | |
|--------------|------------|------|------|
| MODEL | LTM230HT05 | Page | 1/33 |
|--------------|------------|------|------|

Contents

General Description ----- (3)

1. Absolute Maximum Ratings ----- (4)

2. Optical Characteristics ----- (6)

3. Electrical Characteristics -----(11)

 3.1 TFT LCD Module

 3.2 Back Light Unit

4. Block Diagram ----- (15)

 4.1 TFT LCD Module

 4.2 Back Light Unit

5. Input Terminal Pin Assignment ----- (16)

 5.1 Input Signal & Power

 5.2 LVDS Interface

 5.3 Back Light Unit

 5.4 Input Signals, Basic Display Colors and Gray Scale of Each Color

6. Interface Timing ----- (25)

 6.1 Timing Parameters (DE only mode)

 6.2 Timing Diagrams of interface Signal (DE only mode)

 6.3 Power ON/OFF Sequence

 6.4 VDD Power Dip Condition

7. Outline Dimension ----- (29)

8. General Precaution ----- (31)

 8.1 Handling

 8.2 Storage

 8.3 Operation

 8.4 Operation Condition Guide

 8.5 Others

General Description

Description

LTM230HT05 is a color active matrix liquid crystal display (LCD) that uses amorphous silicon TFT (Thin Film Transistor) as switching components. This model is composed of a TFT LCD panel, a driver circuit and a back light unit. The resolution of a 23.0" is 1920 x 1080 and this model can display up to 16.7 millions colors.

Features

- High contrast ratio, high aperture structure
- High speed response
- FHD (1920 x 1080 pixels) resolution
- White LED Edge slim Backlight (1-side)
- DE (Data Enable) only mode
- LVDS (Low Voltage Differential Signaling) interface (2pixel/clock)
- RoHS, Halogen Free
- TCO 03' compliance

Applications

- Workstation & desktop monitors
 - Display terminals for AV application products
 - Monitors for industrial machine
- * If the module is used to other applications besides the above, please contact SEC in advance.

General Information

| Items | Specification | Unit | Note |
|---------------------|------------------------------|-------------------|------|
| Pixel Pitch | 0.2655(H) x 0.2655(W) | mm | |
| Active Display Area | 509.76(H) x 286.74(V) | mm | |
| Surface Treatment | Haze 25% , Hard coating (3H) | | |
| Display Colors | 16.7M (Hi-FRC) | colors | |
| Number of Pixels | 1,920 x 1,080 | pixel | |
| Pixel Arrangement | RGB vertical stripe | | |
| Display Mode | Normally White | | |
| Luminance of White | 250(Typ.) | cd/m ² | |

MODEL

LTM230HT05

Page

3/33

Mechanical Information

| Item | | Min. | Typ. | Max. | Unit | Note |
|-------------|----------------|-------|-------|-------|------|--|
| Module size | Horizontal (H) | 533.5 | 534.0 | 534.5 | mm | - |
| | Vertical (V) | 311.2 | 311.7 | 312.2 | mm | |
| | Depth (D) | - | - | 12.0 | mm | Partially 12.3mm in the circuit area. Refer to the page 30. |
| Weight | | - | - | 2,200 | g | LCD module only |

Note (1) Mechanical tolerance is $\pm 0.5\text{mm}$ unless there is a special comment.

1. Absolute Maximum Ratings

If the condition exceeds maximum ratings, it can cause malfunction or unrecoverable damage to the device.

| Item | Symbol | Min. | Max. | Unit | Note |
|---|-----------|---------|------|------|--------|
| Power Supply Voltage | V_{DD} | GND-0.5 | 6.5 | V | (1) |
| Data Signal | V_{sig} | - | 5 | V | |
| Storage temperature | T_{STG} | -25 | 60 | | (2) |
| Center of Glass surface temperature (Operation) | T_{OPR} | 0 | 50 | | (2) |
| Shock (non - operating) | S_{nop} | - | 50 | G | (3)(5) |
| Vibration (non - operating) | V_{nop} | - | 1.5 | G | (4)(5) |

Note (1) $T_a = 25 \pm 2 \text{ }^\circ\text{C}$

- (2) Temperature and relative humidity range are shown in the figure below.
 - a. 90 % RH Max. (Ta 39 °C)
 - b. Maximum wet-bulb temperature at 39 °C or less. (Ta 39 °C)
 - c. No condensation
- (3) 11ms, sine wave, one time for ±X, ±Y, ±Z axis
- (4) 10-300 Hz, Sweep rate 10min, 30min for X,Y,Z axis
- (5) At vibration and shock test, the fixture which holds the module to be tested has to be hard and rigid enough so that the module would not be twisted or bent by the fixture.

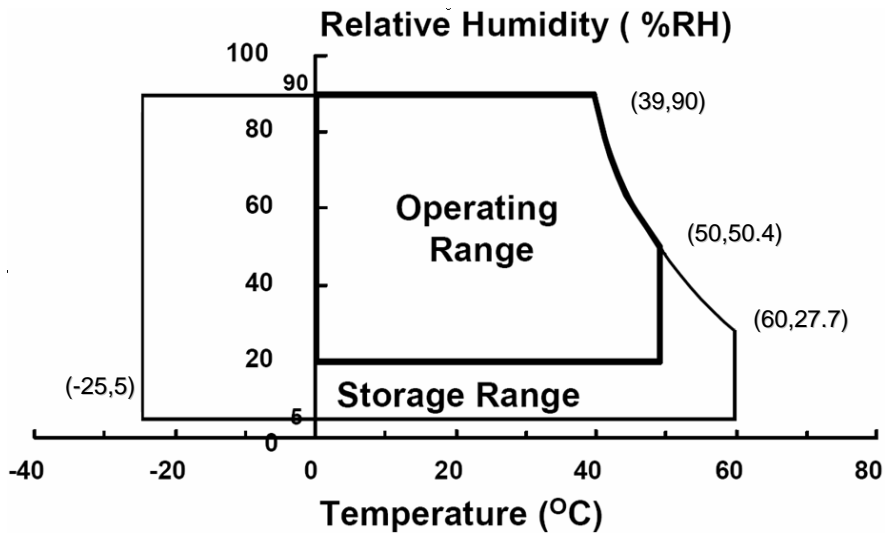

Fig. Temperature and Relative humidity range

2. Optical Characteristics

PRODUCT INFORMATION

The optical characteristics should be measured in a dark room or equivalent.

Measuring equipment : SR-3, RD-80S (TOPCON), EZ-Contrast (Eldim)

($T_a = 25 \pm 2^\circ\text{C}$, $V_{DD}=5\text{V}$, $f_v=60\text{Hz}$, $f_{DCLK}=67.3\text{MHz}$, $I_f=252\text{mA}$)

| Item | Symbol | Condition | Min. | Typ. | Max. | Unit | Note |
|--|--------|-----------|--------|-------|--------|-------------------|-----------------|
| Contrast Ratio (Center of screen) | C/R | | - | 1000 | - | | (3) SR-3 |
| Response Time(On/Off) | On/Off | Tr + Tf | - | 5 | 8 | msec | (5) RD-80S |
| Luminance of White (Center of screen) | Y_L | | 200 | 250 | - | cd/m ² | (6) SR-3 |
| Color Chromaticity (CIE 1931) | Red | Rx | -0.030 | 0.633 | +0.030 | | (7),(8) SR-3 |
| | | Ry | | 0.340 | | | |
| | Green | Gx | | 0.320 | | | |
| | | Gy | | 0.622 | | | |
| | Blue | Bx | | 0.155 | | | |
| | | By | | 0.042 | | | |
| | White | Wx | | 0.313 | | | |
| | | Wy | | 0.329 | | | |
| Color Chromaticity (CIE 1976) | Red | Ru' | - | 0.436 | - | | |
| | | Rv' | - | 0.526 | - | | |
| | Green | Gu' | - | 0.130 | - | | |
| | | Gv' | - | 0.570 | - | | |
| | Blue | Bu' | - | 0.194 | - | | |
| | | Bv' | - | 0.118 | - | | |
| | White | Wu' | - | 0.198 | - | | |
| | | Wv' | - | 0.468 | - | | |
| C.G.L (ACC ONLY) | White | u'v' | - | - | 0.02 | | (9) |

* C.G.L : Color Grayscale Linearity

MODEL

LTM230HT05

Page

6/33

PRODUCT INFORMATION

| Item | Symbol | Condition | Min. | Typ. | Max. | Unit | Note | |
|-------------------------------------|-----------|-----------|-------|------|------|------|-------------|------------------------|
| Color Gamut | - | | - | 72 | - | % | | |
| Color Temperature | - | | - | 6500 | - | K | | |
| Viewing Angle | Hor. | L | CR 10 | 70 | 85 | - | Degrees | (8) EZ- Contrast |
| | | R | | 70 | 85 | - | | |
| | Ver. | U | | 70 | 80 | - | | |
| | | D | | 70 | 80 | - | | |
| Brightness Uniformity (9 Points) | B_{uni} | | - | - | 25 | % | (4) SR-3 | |

Note (1) Test Equipment Setup

The measurement should be executed in a stable, windless and dark room between 30min after lighting the back light at the given temperature for stabilization of the back light. This should be measured in the center of screen.

LED Forward current : $I_f = 252 \text{ mA}$ Environment condition : $T_a = 25 \pm 2 \text{ }^\circ\text{C}$

| | |
|----------------|-------|
| Photo detector | Field |
| SR-3 | 2 ° |

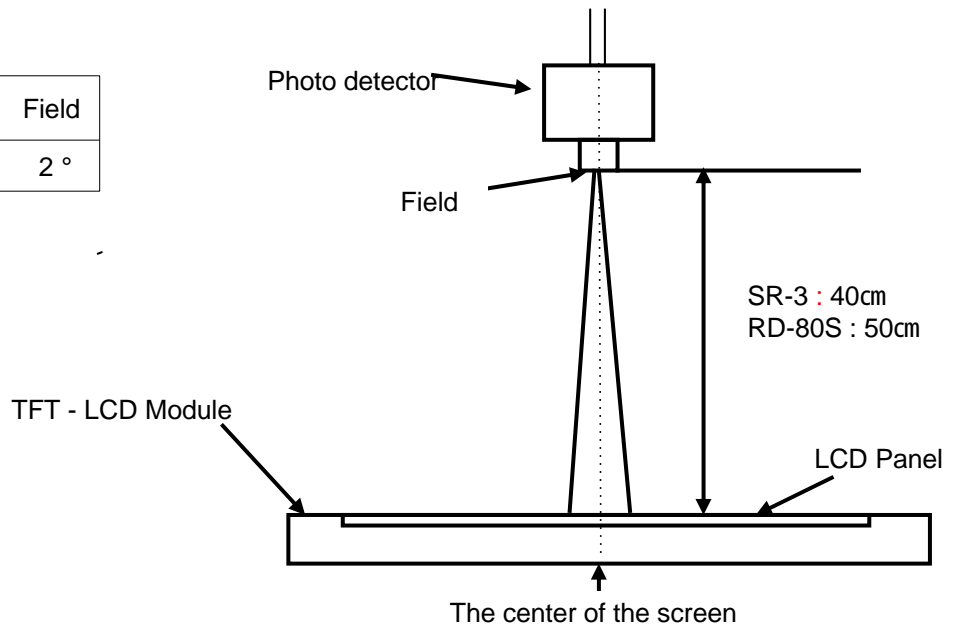

Note (2) Definition of test point

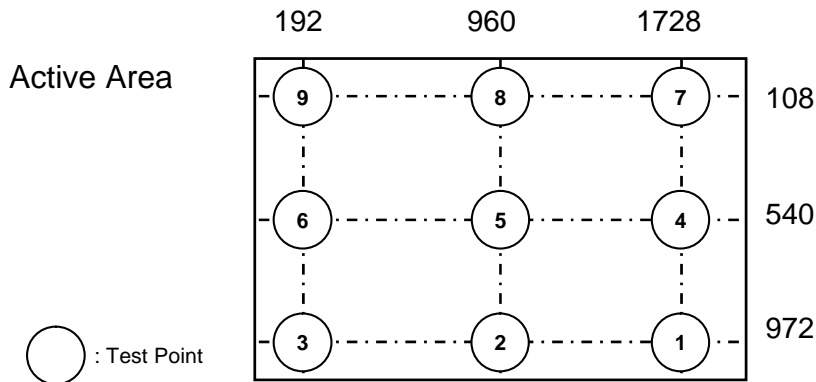

Note (3) Definition of Contrast Ratio (C/R)

: Ratio of gray max (Gmax) & gray min (Gmin) at the center point of the panel

$$CR = \frac{G \text{ max}}{G \text{ min}}$$

Gmax : Luminance with all pixels white

Gmin : Luminance with all pixels black

Note (4) Definition of 9 points brightness uniformity

$$Buni = 100 \times \frac{(B \text{ max} - B \text{ min})}{B \text{ max}}$$

Bmax : Maximum brightness

Bmin : Minimum brightness

Note (5) Definition of Response time : Sum of Tr, Tf

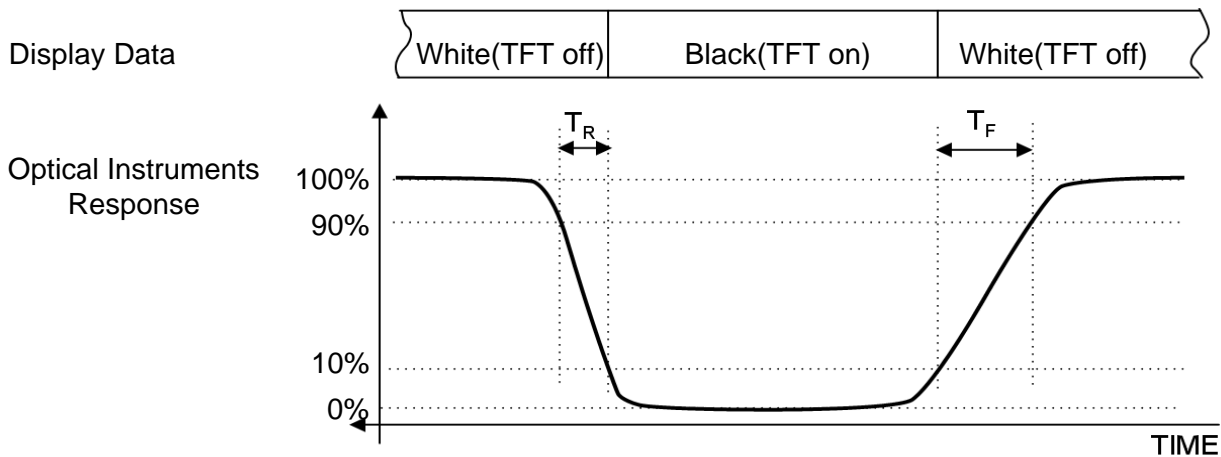

PRODUCT INFORMATION

Note (6) Definition of Luminance of White : Luminance of white at center point

Note (7) Definition of Color Chromaticity (CIE 1931, CIE1976)
Color coordinate of Red, Green, Blue & White at center point

Note (8) Definition of Viewing Angle
: Viewing angle range (CR 10)

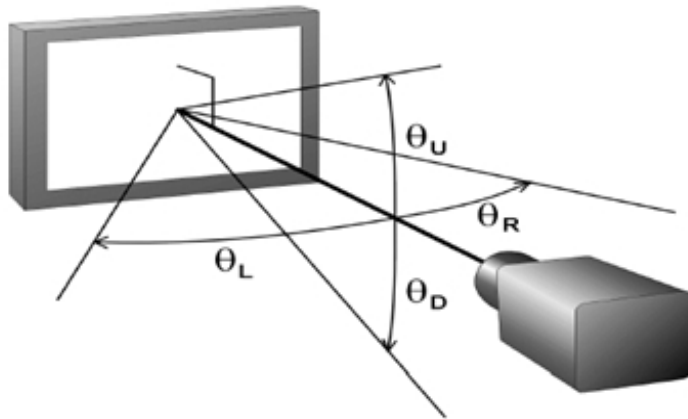

Note (9) Color Grayscale Linearity

a. Test image : 100% full white pattern with a test pattern as below

b. Test pattern : Squares, 40mm by 40mm in size, filled with 255, 225, 195, 165, 135 and 105 grays steps should be arranged at the center of the screen.



c. Test method

-1st gray step : move a square of 255 gray level should be moved into the center of the screen and measure luminance and u' and v' coordinates.

- Next gray step : Move a 225 gray square into the center and measure both luminance and coordinates, too.

d. Test evaluation

$$\Delta u' v' = \sqrt{(u'_A - u'_B)^2 + (v'_A - v'_B)^2}$$

Where A, B : 2 gray levels found to have the largest color differences between them

i.e. get the largest u' and v' of each 6 pair of u' and v' and calculate the $u'v'$.

3. Electrical Characteristics

3.1 TFT LCD Module

The connector for display data & timing signal should be connected.

Ta = 25°C

| Item | Symbol | Min. | Typ. | Max. | Unit | Note | |
|----------------------------|--|------------|--------------------|-------|----------------------|------|---------|
| Voltage of Power Supply | V_{DD} | 4.5 | 5.0 | 5.5 | V | (1) | |
| LVDS Input Characteristics | Differential Input Voltage for LVDS Receiver Threshold | High | - | - | +100 | mV | (2) |
| | | Low | -100 | - | - | mV | |
| | LVDS skew | t_{SKEW} | -300 | - | 300 | ps | (3) |
| | Differential input voltage | $ V_{ID} $ | 200 | - | 600 | mV | (4) |
| | Input voltage range (single-ended) | V_{IN} | 0 | - | 2.4 | V | (4) |
| | Common mode voltage | V_{CM} | 0+ $ V_{ID} /2$ | 1.2 | 2.4- $ V_{ID} /2$ | V | (4) |
| Current of Power Supply | (a) Black | I_{DD} | - | 1,400 | - | mA | (5),(6) |
| | (b) White | | - | 900 | - | mA | |
| | (c) Dot | | - | 1,800 | 2,200 | mA | |
| Vsync Frequency | f_V | 49.0 | 60.0 | 75.0 | Hz | | |
| Hsync Frequency | f_H | 54.2 | 66.0 | 83.8 | kHz | | |
| Main Frequency | f_{DCLK} | 56.4 | 67.3 | 83.0 | MHz | | |
| Rush Current | I_{RUSH} | - | - | 5.0 | A | (7) | |

Note (1) The ripple voltage should be controlled under 10% of V_{DD} .

- (2) Differential receiver voltage definitions and propagation delay and transition time test circuit
- All input pulses have frequency = 10MHz, t_R or $t_F=1ns$
 - C_L includes all probe and fixture capacitance

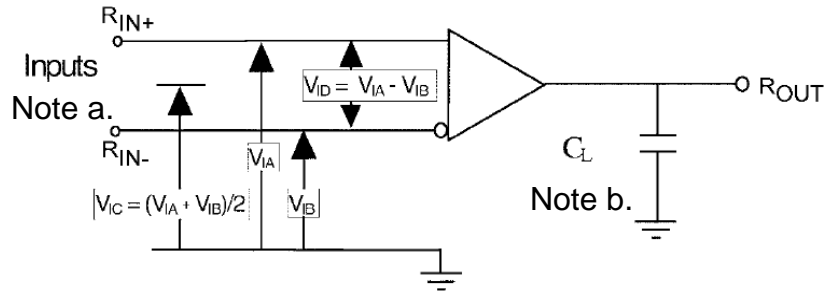

- (3) LVDS Receiver DC parameters are measured under static and steady conditions which may not be reflective of its performance in the end application.

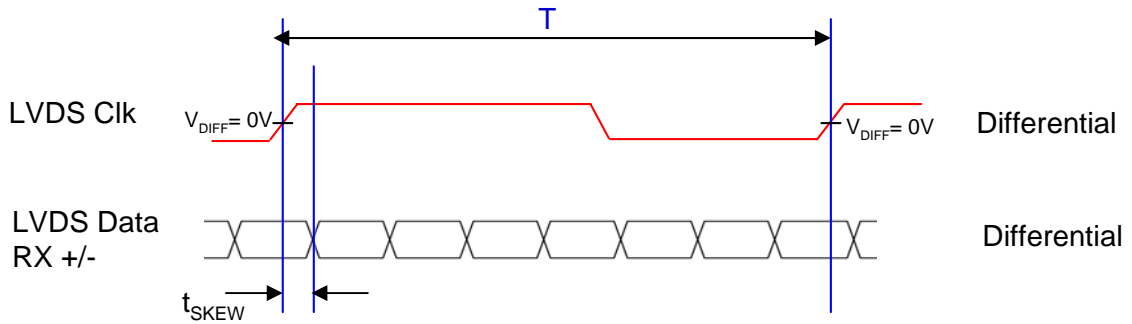

where t_{skew} : skew between LVDS clock & LVDS data,
 T : 1 period time of LVDS clock

cf) (-/+) of 300psec means LVDS data goes before or after LVDS clock.

- (4) Definition of V_{ID} and V_{CM} using single-end signals

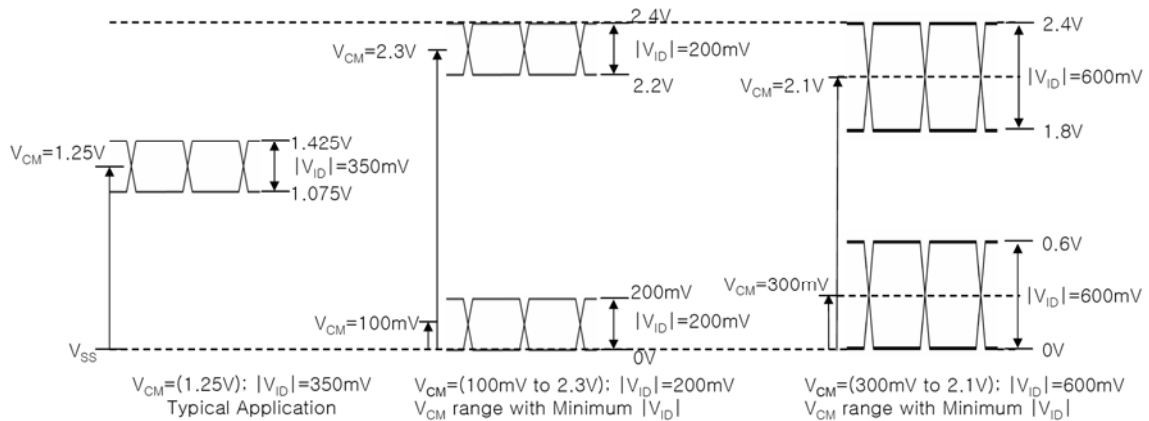

(5) $f_V=60\text{Hz}$, $f_{\text{DCLK}} = 67.3\text{MHz}$, $V_{\text{DD}} = 5.0\text{V}$, DC Current.

(6) Power dissipation check pattern (LCD Module only)

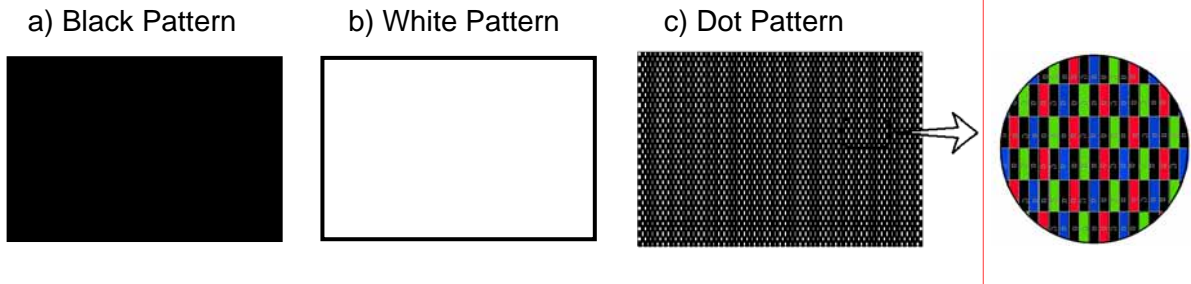

(7) Measurement Condition

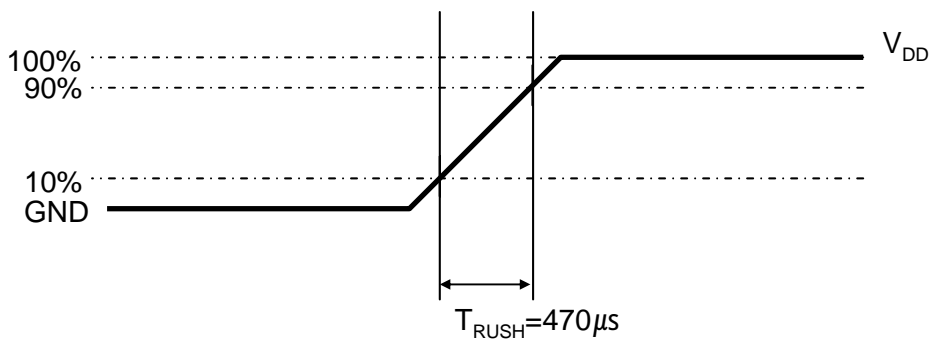

Rush Current I_{RUSH} can be measured when T_{RUSH} is $470\mu\text{s}$.

3.2 Back Light Unit

3.2.1 The characteristics of LED bar

The back light unit is composed of WLED.

Ta=25 ± 2°C

| Item | Symbol | Min. | Typ. | Max. | Unit | Note |
|---------------------|----------------|--------|------|------|------|------|
| LED Forward Current | I _F | - | 252 | 260 | mA | - |
| LED Array Voltage | V _P | - | 56.1 | 59.5 | V | - |
| Operating Life Time | Hr | 30,000 | - | - | Hour | (2) |

Note (1) The above specification is not for the converter output, but for the LED bar.

The LED bar consists of 68 LED packages ; 4 parallel X 17 serial

(2) Life time(Hr) is defined as the time when brightness of a LED package itself becomes 50% or less than its original value at the condition of Ta=25 ± 2°C and I_F=252mA.

4. BLOCK DIAGRAM

4.1 TFT LCD Module

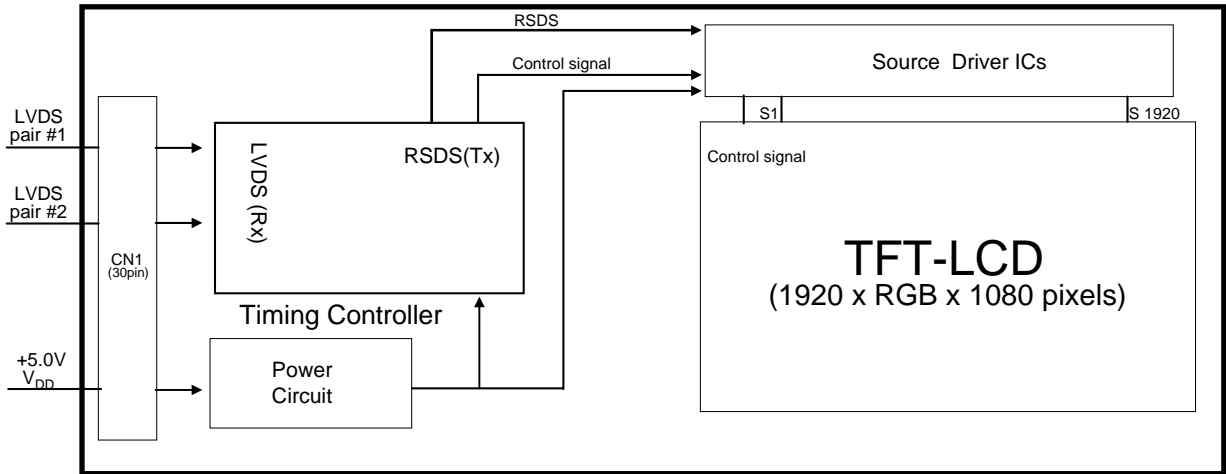

4.2 Back Light Unit

Connector: Yenho 12507WR-06L(6-pin connector) or equivalent

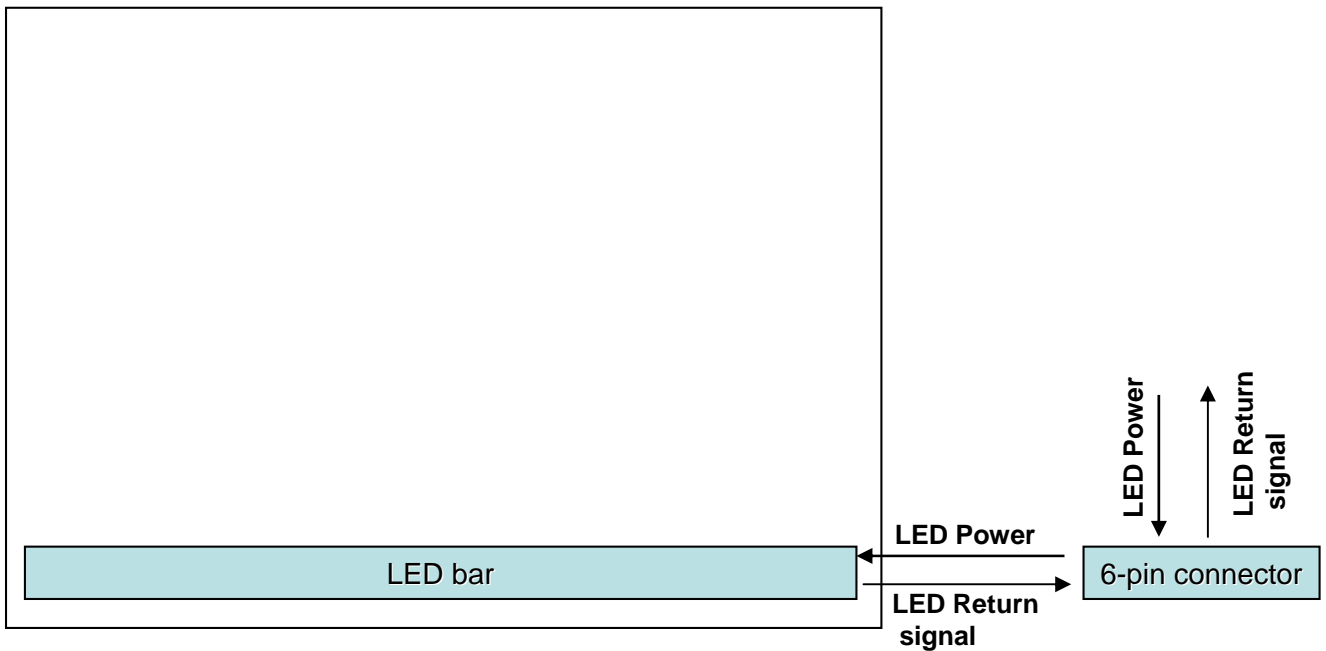

For detail connector information, please refer to page 23.

| | | | |
|--------------|------------|------|-------|
| MODEL | LTM230HT05 | Page | 15/33 |
|--------------|------------|------|-------|

5. Input Terminal Pin Assignment

5.1. Input Signal & Power (Connector : UJU IS100-L300-C23-S or equivalent)

| PIN NO | SYMBOL | FUNCTION |
|--------|--------|---|
| 1 | RXO0N | Negative LVDS differential data output |
| 2 | RXO0P | Positive LVDS differential data output |
| 3 | RXO1N | Negative LVDS differential data output |
| 4 | RXO1P | Positive LVDS differential data output |
| 5 | RXO2N | Negative LVDS differential data output |
| 6 | RXO2P | Positive LVDS differential data output |
| 7 | GND | Ground |
| 8 | RXOC- | Negative Sampling Clock (ODD data) |
| 9 | RXOC+ | Positive Sampling Clock (ODD data) |
| 10 | RXO3N | Negative LVDS differential data output |
| 11 | RXO3P | Positive LVDS differential data output |
| 12 | RXE0N | Negative LVDS differential data output |
| 13 | RXE0P | Positive LVDS differential data output |
| 14 | GND | Ground |
| 15 | RXE1N | Negative LVDS differential data output |
| 16 | RXE1P | Positive LVDS differential data output |
| 17 | GND | Ground |
| 18 | RXE2N | Negative LVDS differential data output |
| 19 | RXE2P | Positive LVDS differential data output |
| 20 | RXEC- | Negative Sampling Clock (EVEN data) |
| 21 | RXEC+ | Positive Sampling Clock (EVEN data) |
| 22 | RXE3N | Negative LVDS differential data output |
| 23 | RXE3P | Positive LVDS differential data output |
| 24 | GND | Ground |
| 25 | NC | * CE (For LCD internal use only. Do not connect) |
| 26 | NC | * CTL (For LCD internal use only. Do not connect) |
| 27 | NC | No Connection |
| 28 | VDD | Power Supply : +5V |
| 29 | VDD | |
| 30 | VDD | |

* If the system already uses the 25, 26pins, it should keep under GND level
The voltage applied to those pins should not exceed -200mV.

Note) Pin number starts from Left side

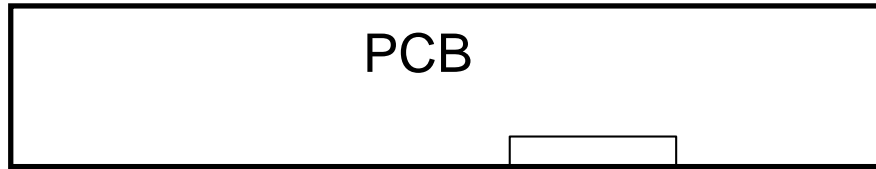

Pin No. 1

Pin No. 30

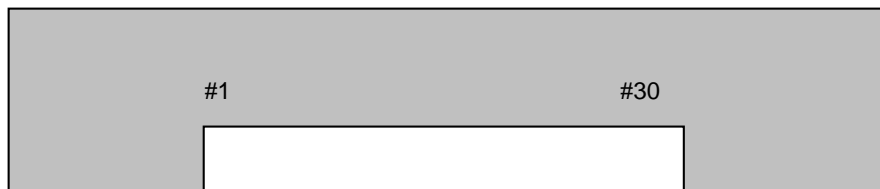

UJU IS100-L30B-C23-S or equivalent

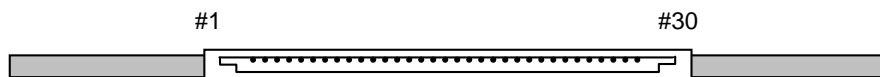

Fig. Connector diagram

- a. All GND pins should be connected together and also be connected to the LCD's metal chassis.
- b. All power input pins should be connected together.
- c. All NC pins should be separated from other signal or power.

5.2 LVDS Interface (1)

5.2.1 Odd Pixel Data (1st pixel data)

| LVDS Transmitter (DS90C383 , DS90C385) Signal Interface | | | | | | |
|---|--------|---------------------|----------------------------|--------------------|---------------------------------|----------------|
| Device Input Pin | | Device Input Signal | | Output Signal | To LTM230HT05 Interface (CN1) | |
| No | Symbol | Symbol | Function | | Terminal | Symbol |
| 51 | TXIN0 | RO0 | Red Odd Pixel Data (LSB) | TXOUT0- TXOUT0+ | No. 1 No. 2 | RXO0- RXO0+ |
| 52 | TXIN1 | RO1 | Red Odd Pixel Data | | | |
| 54 | TXIN2 | RO2 | Red Odd Pixel Data | | | |
| 55 | TXIN3 | RO3 | Red Odd Pixel Data | | | |
| 56 | TXIN4 | RO4 | Red Odd Pixel Data | | | |
| 2 | TXIN5 | RO7 | Red Odd Pixel Data (MSB) | TXOUT3- TXOUT3+ | No. 10 No. 11 | RXO3- RXO3+ |
| 3 | TXIN6 | RO5 | Red Odd Pixel Data | TXOUT0- TXOUT0+ | No. 1 No. 2 | RXO0- RXO0+ |
| 4 | TXIN7 | GO0 | Green Odd Pixel Data (LSB) | | | |
| 6 | TXIN8 | GO1 | Green Odd Pixel Data | TXOUT1- TXOUT1+ | No. 3 No. 4 | RXO1- RXO1+ |
| 7 | TXIN9 | GO2 | Green Odd Pixel Data | | | |
| 8 | TXIN10 | GO6 | Green Odd Pixel Data | TXOUT3- TXOUT3+ | No. 10 No. 11 | RXO3- RXO3+ |
| 10 | TXIN11 | GO7 | Green Odd Pixel Data (MSB) | | | |
| 11 | TXIN12 | GO3 | Green Odd Pixel Data | TXOUT1- TXOUT1+ | No. 3 No. 4 | RXO1- RXO1+ |
| 12 | TXIN13 | GO4 | Green Odd Pixel Data | | | |
| 14 | TXIN14 | GO5 | Green Odd Pixel Data | | | |
| 15 | TXIN15 | BO0 | Blue Odd Pixel Data (LSB) | | | |
| 16 | TXIN16 | BO6 | Blue Odd Pixel Data | TXOUT3- TXOUT3+ | No. 10 No. 11 | RXO3- RXO3+ |
| 18 | TXIN17 | BO7 | Blue Odd Pixel Data (MSB) | | | |
| 19 | TXIN18 | BO1 | Blue Odd Pixel Data | TXOUT1- TXOUT1+ | No. 3 No. 4 | RXO1- RXO1+ |
| 20 | TXIN19 | BO2 | Blue Odd Pixel Data | TXOUT2- TXOUT2+ | No. 5 No. 6 | RXO2- RXO2+ |
| 22 | TXIN20 | BO3 | Blue Odd Pixel Data | | | |
| 23 | TXIN21 | BO4 | Blue Odd Pixel Data | | | |
| 24 | TXIN22 | BO5 | Blue Odd Pixel Data | | | |
| 50 | TXIN27 | RO6 | Red Odd Pixel Data | TXOUT3- TXOUT3+ | No. 10 No. 11 | RXO3- RXO3+ |

5.2.2 Even Pixel Data (2nd pixel data)

| LVDS Transmitter (DS90C383, DS90C385) Signal Interface | | | | | | |
|---|--------|---------------------|-----------------------------|--------------------|---------------------------------|----------------|
| Device Input Pin | | Device Input Signal | | Output Signal | To LTM230HT05 Interface (CN1) | |
| No | Symbol | Symbol | Function | | Terminal | Symbol |
| 51 | TXIN0 | RE0 | Red Even Pixel Data (LSB) | TXOUT0- TXOUT0+ | No. 12 No. 13 | RXE0- RXE0+ |
| 52 | TXIN1 | RE1 | Red Even Pixel Data | | | |
| 54 | TXIN2 | RE2 | Red Even Pixel Data | | | |
| 55 | TXIN3 | RE3 | Red Even Pixel Data | | | |
| 56 | TXIN4 | RE4 | Red Even Pixel Data | | | |
| 2 | TXIN5 | RE7 | Red Even Pixel Data (MSB) | TXOUT3- TXOUT3+ | No. 22 No. 23 | RXE3- RXE3+ |
| 3 | TXIN6 | RE5 | Red Even Pixel Data | TXOUT0- TXOUT0+ | No. 12 No. 13 | RXE0- RXE0+ |
| 4 | TXIN7 | GE0 | Green Even Pixel Data (LSB) | | | |
| 6 | TXIN8 | GE1 | Green Even Pixel Data | TXOUT1- TXOUT1+ | No. 15 No. 16 | RXE1- RXE1+ |
| 7 | TXIN9 | GE2 | Green Even Pixel Data | | | |
| 8 | TXIN10 | GE6 | Green Even Pixel Data | TXOUT3- TXOUT3+ | No. 22 No. 23 | RXE3- RXE3+ |
| 10 | TXIN11 | GE7 | Green Even Pixel Data (MSB) | | | |
| 11 | TXIN12 | GE3 | Green Even Pixel Data | TXOUT1- TXOUT1+ | No. 15 No. 16 | RXE1- RXE1+ |
| 12 | TXIN13 | GE4 | Green Even Pixel Data | | | |
| 14 | TXIN14 | GE5 | Green Even Pixel Data | | | |
| 15 | TXIN15 | BE0 | Blue Even Pixel Data (LSB) | | | |
| 16 | TXIN16 | BE6 | Blue Even Pixel Data | TXOUT3- TXOUT3+ | No. 22 No. 23 | RXE3- RXE3+ |
| 18 | TXIN17 | BE7 | Blue Even Pixel Data (MSB) | | | |
| 19 | TXIN18 | BE1 | Blue Even Pixel Data | TXOUT1- TXOUT1+ | No. 15 No. 16 | RXE1- RXE1+ |
| 20 | TXIN19 | BE2 | Blue Even Pixel Data | TXOUT2- TXOUT2+ | No. 18 No. 19 | RXE2- RXE2+ |
| 22 | TXIN20 | BE3 | Blue Even Pixel Data | | | |
| 23 | TXIN21 | BE4 | Blue Even Pixel Data | | | |
| 24 | TXIN22 | BE5 | Blue Even Pixel Data | | | |
| 50 | TXIN27 | RE6 | Red Even Pixel Data | TXOUT3- TXOUT3+ | No. 22 No. 23 | RXE3- RXE3+ |

5.2 LVDS Interface (2)

5.2.3 Odd Pixel Data (1st pixel data)

| LVDS Transmitter (DS90C387) Signal Interface | | | | | | |
|---|--------|---------------------|----------------------------|---------------|---------------------------------|----------------|
| Device Input Pin | | Device Input Signal | | Output Signal | To LTM230HT05 Interface (CN1) | |
| No | Symbol | Symbol | Function | | Terminal | Symbol |
| 10 | R10 | RO0 | Red Odd Pixel Data (LSB) | A0M A0P | No. 1 No. 2 | RXO0- RXO0+ |
| 9 | R11 | RO1 | Red Odd Pixel Data | | | |
| 8 | R12 | RO2 | Red Odd Pixel Data | | | |
| 7 | R13 | RO3 | Red Odd Pixel Data | | | |
| 6 | R14 | RO4 | Red Odd Pixel Data | | | |
| 3 | R17 | RO7 | Red Odd Pixel Data (MSB) | A3M A3P | No. 10 No. 11 | RXO3- RXO3+ |
| 5 | R15 | RO5 | Red Odd Pixel Data | A0M A0P | No. 1 No. 2 | RXO0- RXO0+ |
| 2 | G10 | GO0 | Green Odd Pixel Data (LSB) | | | |
| 1 | G11 | GO1 | Green Odd Pixel Data | A1M A1P | No. 3 No. 4 | RXO1- RXO1+ |
| 100 | G12 | GO2 | Green Odd Pixel Data | | | |
| 94 | G16 | GO6 | Green Odd Pixel Data | A3M A3P | No. 10 No. 11 | RXO3- RXO3+ |
| 93 | G17 | GO7 | Green Odd Pixel Data (MSB) | | | |
| 99 | G13 | GO3 | Green Odd Pixel Data | A1M A1P | No. 3 No. 4 | RXO1- RXO1+ |
| 96 | G14 | GO4 | Green Odd Pixel Data | | | |
| 95 | G15 | GO5 | Green Odd Pixel Data | | | |
| 92 | B10 | BO0 | Blue Odd Pixel Data (LSB) | A3M A3P | No. 10 No. 11 | RXO3- RXO3+ |
| 86 | B16 | BO6 | Blue Odd Pixel Data | | | |
| 85 | B17 | BO7 | Blue Odd Pixel Data (MSB) | | | |
| 91 | B11 | BO1 | Blue Odd Pixel Data | A1M A1P | No. 3 No. 4 | RXO1- RXO1+ |
| 90 | B12 | BO2 | Blue Odd Pixel Data | A2M A2P | No. 5 No. 6 | RXO2- RXO2+ |
| 89 | B13 | BO3 | Blue Odd Pixel Data | | | |
| 88 | B14 | BO4 | Blue Odd Pixel Data | | | |
| 87 | B15 | BO5 | Blue Odd Pixel Data | | | |
| 4 | R16 | RO6 | Red Odd Pixel Data | A3M A3P | No. 10 No. 11 | RXO3- RXO3+ |

5.2.4 Even Pixel Data (2nd pixel data)

| LVDS Transmitter (DS90C387) Signal Interface | | | | | | |
|---|--------|---------------------|-----------------------------|---------------|---------------------------------|----------------|
| Device Input Pin | | Device Input Signal | | Output Signal | To LTM230HT05 Interface (CN1) | |
| No | Symbol | Symbol | Function | | Terminal | Symbol |
| 84 | R20 | RE0 | Red Even Pixel Data (LSB) | A4M A4P | No. 12 No. 13 | RXE0- RXE0+ |
| 81 | R21 | RE1 | Red Even Pixel Data | | | |
| 80 | R22 | RE2 | Red Even Pixel Data | | | |
| 79 | R23 | RE3 | Red Even Pixel Data | | | |
| 78 | R24 | RE4 | Red Even Pixel Data | | | |
| 75 | R27 | RE7 | Red Even Pixel Data (MSB) | A7M A7P | No. 22 No. 23 | RXE3- RXE3+ |
| 77 | R25 | RE5 | Red Even Pixel Data | A4M A4P | No. 12 No. 13 | RXE0- RXE0+ |
| 74 | G20 | GE0 | Green Even Pixel Data (LSB) | | | |
| 73 | G21 | GE1 | Green Even Pixel Data | A5M A5P | No. 15 No. 16 | RXE1- RXE1+ |
| 72 | G22 | GE2 | Green Even Pixel Data | | | |
| 66 | G26 | GE6 | Green Even Pixel Data | A7M A7P | No. 22 No. 23 | RXE3- RXE3+ |
| 65 | G27 | GE7 | Green Even Pixel Data (MSB) | | | |
| 71 | G23 | GE3 | Green Even Pixel Data | A5M A5P | No. 15 No. 16 | RXE1- RXE1+ |
| 70 | G24 | GE4 | Green Even Pixel Data | | | |
| 69 | G25 | GE5 | Green Even Pixel Data | | | |
| 64 | B20 | BE0 | Blue Even Pixel Data (LSB) | A7M A7P | No. 22 No. 23 | RXE3- RXE3+ |
| 58 | B26 | BE6 | Blue Even Pixel Data | | | |
| 57 | B27 | BE7 | Blue Even Pixel Data (MSB) | | | |
| 63 | B21 | BE1 | Blue Even Pixel Data | A5M A5P | No. 15 No. 16 | RXE1- RXE1+ |
| 62 | B22 | BE2 | Blue Even Pixel Data | A6M A6P | No. 18 No. 19 | RXE2- RXE2+ |
| 61 | B23 | BE3 | Blue Even Pixel Data | | | |
| 60 | B24 | BE4 | Blue Even Pixel Data | | | |
| 59 | B25 | BE5 | Blue Even Pixel Data | | | |
| 76 | R26 | RE6 | Red Even Pixel Data | A7M A7P | No. 22 No. 23 | RXE3- RXE3+ |

5.2.5 Timing Diagrams of LVDS For Transmitting
 LVDS Receiver : Integrated T-CON

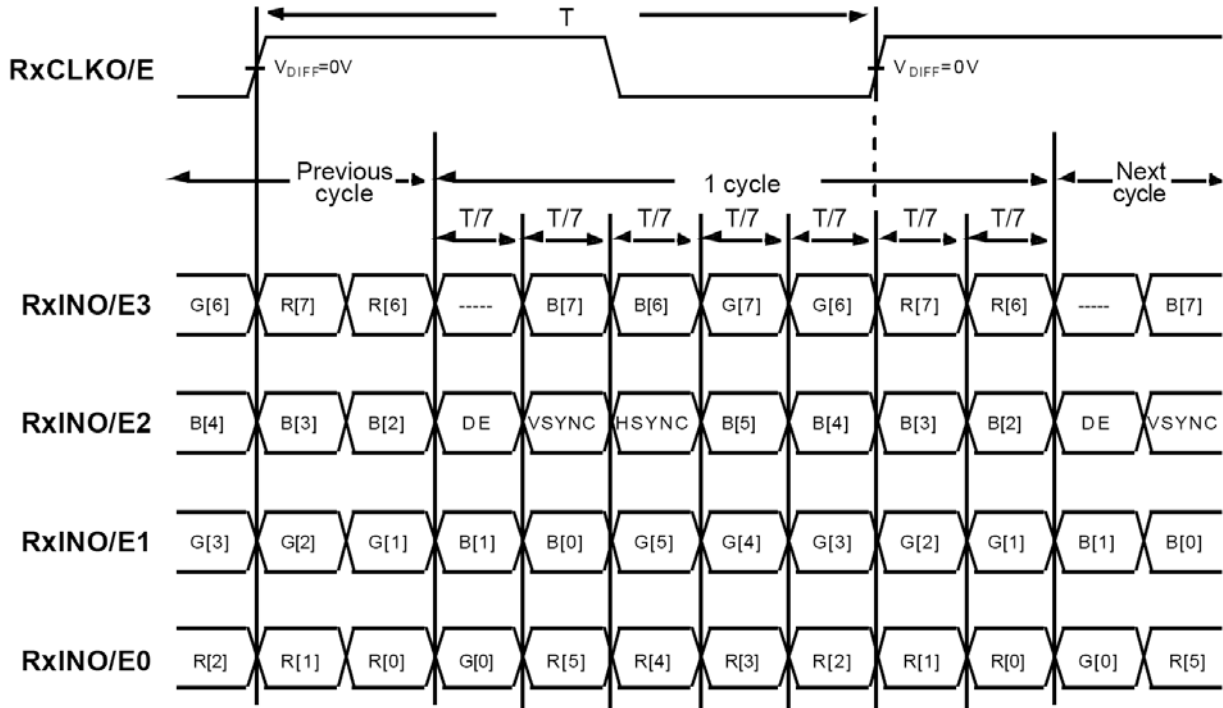

5.3 Back Light Unit

LED Bar input connector : 12507WR-06L, Yenho (6-pin Connector)

| Pin No. | Pin description | Description |
|---------|-----------------|-------------------------|
| 1 | Channel 1 | Channel 1 return signal |
| 2 | Channel 2 | Channel 2 return signal |
| 3 | Vin | LED power input |
| 4 | Vin | LED power input |
| 5 | Channel 3 | Channel 3 return signal |
| 6 | Channel 4 | Channel 4 return signal |

Note) Pin number starts from Left side

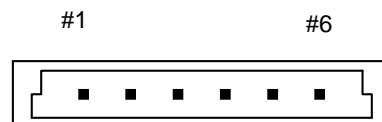
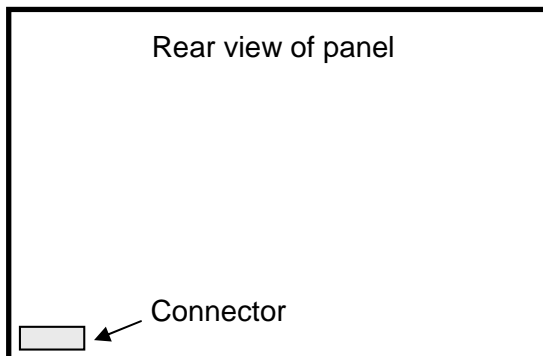

Fig. Connector diagram

5.4 Input Signals, Basic Display Colors and Gray Scale of Each Color

| COLOR | DISPLAY (8bit) | DATA SIGNAL | | | | | | | | | | | | | | | | | | | | | | | | | | | | GRAY SCALE LEVEL |
|---------------------|----------------|-------------|----|----|----|----|----|----|-------|----|----|----|----|----|----|------|----|----|----|----|----|----|----|----|----|------|---------|---|---|------------------|
| | | RED | | | | | | | GREEN | | | | | | | BLUE | | | | | | | | | | | | | | |
| | | R0 | R1 | R2 | R3 | R4 | R5 | R6 | R7 | G0 | G1 | G2 | G3 | G4 | G5 | G6 | G7 | B0 | B1 | B2 | B3 | B4 | B5 | B6 | B7 | | | | | |
| BASIC COLOR | BLACK | 0 | 0 | 0 | 0 | 0 | 0 | 0 | 0 | 0 | 0 | 0 | 0 | 0 | 0 | 0 | 0 | 0 | 0 | 0 | 0 | 0 | 0 | 0 | 0 | 0 | 0 | 0 | - | |
| | BLUE | 0 | 0 | 0 | 0 | 0 | 0 | 0 | 0 | 0 | 0 | 0 | 0 | 0 | 0 | 0 | 0 | 1 | 1 | 1 | 1 | 1 | 1 | 1 | 1 | 1 | 1 | - | | |
| | GREEN | 0 | 0 | 0 | 0 | 0 | 0 | 0 | 0 | 1 | 1 | 1 | 1 | 1 | 1 | 1 | 1 | 0 | 0 | 0 | 0 | 0 | 0 | 0 | 0 | 0 | 0 | - | | |
| | CYAN | 0 | 0 | 0 | 0 | 0 | 0 | 0 | 0 | 1 | 1 | 1 | 1 | 1 | 1 | 1 | 1 | 1 | 1 | 1 | 1 | 1 | 1 | 1 | 1 | 1 | 1 | - | | |
| | RED | 1 | 1 | 1 | 1 | 1 | 1 | 1 | 1 | 0 | 0 | 0 | 0 | 0 | 0 | 0 | 0 | 0 | 0 | 0 | 0 | 0 | 0 | 0 | 0 | 0 | 0 | - | | |
| | MAGENTA | 1 | 1 | 1 | 1 | 1 | 1 | 1 | 1 | 0 | 0 | 0 | 0 | 0 | 0 | 0 | 0 | 1 | 1 | 1 | 1 | 1 | 1 | 1 | 1 | 1 | 1 | - | | |
| | YELLOW | 1 | 1 | 1 | 1 | 1 | 1 | 1 | 1 | 1 | 1 | 1 | 1 | 1 | 1 | 1 | 1 | 0 | 0 | 0 | 0 | 0 | 0 | 0 | 0 | 0 | 0 | - | | |
| | WHITE | 1 | 1 | 1 | 1 | 1 | 1 | 1 | 1 | 1 | 1 | 1 | 1 | 1 | 1 | 1 | 1 | 1 | 1 | 1 | 1 | 1 | 1 | 1 | 1 | 1 | 1 | - | | |
| GRAY SCALE OF RED | BLACK | 0 | 0 | 0 | 0 | 0 | 0 | 0 | 0 | 0 | 0 | 0 | 0 | 0 | 0 | 0 | 0 | 0 | 0 | 0 | 0 | 0 | 0 | 0 | 0 | 0 | R0 | | | |
| | DARK | 1 | 0 | 0 | 0 | 0 | 0 | 0 | 0 | 0 | 0 | 0 | 0 | 0 | 0 | 0 | 0 | 0 | 0 | 0 | 0 | 0 | 0 | 0 | 0 | 0 | R1 | | | |
| | | 0 | 1 | 0 | 0 | 0 | 0 | 0 | 0 | 0 | 0 | 0 | 0 | 0 | 0 | 0 | 0 | 0 | 0 | 0 | 0 | 0 | 0 | 0 | 0 | 0 | R2 | | | |
| | | : | : | : | : | : | : | : | : | : | : | : | : | : | : | : | : | : | : | : | : | : | : | : | : | : | R3~R252 | | | |
| | LIGHT | : | : | : | : | : | : | : | : | : | : | : | : | : | : | : | : | : | : | : | : | : | : | : | : | : | | | | |
| | | 1 | 0 | 1 | 1 | 1 | 1 | 1 | 1 | 0 | 0 | 0 | 0 | 0 | 0 | 0 | 0 | 0 | 0 | 0 | 0 | 0 | 0 | 0 | 0 | 0 | R253 | | | |
| | 0 | 1 | 1 | 1 | 1 | 1 | 1 | 1 | 1 | 0 | 0 | 0 | 0 | 0 | 0 | 0 | 0 | 0 | 0 | 0 | 0 | 0 | 0 | 0 | 0 | 0 | R254 | | | |
| RED | 1 | 1 | 1 | 1 | 1 | 1 | 1 | 1 | 0 | 0 | 0 | 0 | 0 | 0 | 0 | 0 | 0 | 0 | 0 | 0 | 0 | 0 | 0 | 0 | 0 | R255 | | | | |
| GRAY SCALE OF GREEN | BLACK | 0 | 0 | 0 | 0 | 0 | 0 | 0 | 0 | 0 | 0 | 0 | 0 | 0 | 0 | 0 | 0 | 0 | 0 | 0 | 0 | 0 | 0 | 0 | 0 | 0 | G0 | | | |
| | DARK | 0 | 0 | 0 | 0 | 0 | 0 | 0 | 0 | 1 | 0 | 0 | 0 | 0 | 0 | 0 | 0 | 0 | 0 | 0 | 0 | 0 | 0 | 0 | 0 | 0 | G1 | | | |
| | | 0 | 0 | 0 | 0 | 0 | 0 | 0 | 0 | 0 | 1 | 0 | 0 | 0 | 0 | 0 | 0 | 0 | 0 | 0 | 0 | 0 | 0 | 0 | 0 | 0 | G2 | | | |
| | | : | : | : | : | : | : | : | : | : | : | : | : | : | : | : | : | : | : | : | : | : | : | : | : | : | G3~G252 | | | |
| | LIGHT | : | : | : | : | : | : | : | : | : | : | : | : | : | : | : | : | : | : | : | : | : | : | : | : | : | | | | |
| | | 0 | 0 | 0 | 0 | 0 | 0 | 0 | 0 | 1 | 0 | 1 | 1 | 1 | 1 | 1 | 1 | 0 | 0 | 0 | 0 | 0 | 0 | 0 | 0 | 0 | G253 | | | |
| | 0 | 0 | 0 | 0 | 0 | 0 | 0 | 0 | 0 | 0 | 1 | 1 | 1 | 1 | 1 | 1 | 1 | 0 | 0 | 0 | 0 | 0 | 0 | 0 | 0 | 0 | G254 | | | |
| GREEN | 0 | 0 | 0 | 0 | 0 | 0 | 0 | 0 | 1 | 1 | 1 | 1 | 1 | 1 | 1 | 1 | 0 | 0 | 0 | 0 | 0 | 0 | 0 | 0 | 0 | G255 | | | | |
| GRAY SCALE OF BLUE | BLACK | 0 | 0 | 0 | 0 | 0 | 0 | 0 | 0 | 0 | 0 | 0 | 0 | 0 | 0 | 0 | 0 | 0 | 0 | 0 | 0 | 0 | 0 | 0 | 0 | 0 | B0 | | | |
| | DARK | 0 | 0 | 0 | 0 | 0 | 0 | 0 | 0 | 0 | 0 | 0 | 0 | 0 | 0 | 0 | 0 | 1 | 0 | 0 | 0 | 0 | 0 | 0 | 0 | 0 | B1 | | | |
| | | 0 | 0 | 0 | 0 | 0 | 0 | 0 | 0 | 0 | 0 | 0 | 0 | 0 | 0 | 0 | 0 | 0 | 1 | 0 | 0 | 0 | 0 | 0 | 0 | 0 | B2 | | | |
| | | : | : | : | : | : | : | : | : | : | : | : | : | : | : | : | : | : | : | : | : | : | : | : | : | : | B3~B252 | | | |
| | LIGHT | : | : | : | : | : | : | : | : | : | : | : | : | : | : | : | : | : | : | : | : | : | : | : | : | : | | | | |
| | | 0 | 0 | 0 | 0 | 0 | 0 | 0 | 0 | 0 | 0 | 0 | 0 | 0 | 0 | 0 | 0 | 1 | 0 | 1 | 1 | 1 | 1 | 1 | 1 | 1 | B253 | | | |
| | 0 | 0 | 0 | 0 | 0 | 0 | 0 | 0 | 0 | 0 | 0 | 0 | 0 | 0 | 0 | 0 | 0 | 0 | 1 | 1 | 1 | 1 | 1 | 1 | 1 | 1 | B254 | | | |
| BLUE | 0 | 0 | 0 | 0 | 0 | 0 | 0 | 0 | 0 | 0 | 0 | 0 | 0 | 0 | 0 | 0 | 1 | 1 | 1 | 1 | 1 | 1 | 1 | 1 | 1 | B255 | | | | |

Note (1) Definition of Gray :
 Rn : Red Gray, Gn : Green Gray, Bn : Blue Gray (n = Gray level)
 Input Signal : 0 = Low level voltage, 1 = High level voltage

6. Interface Timing

6.1 Timing Parameters (DE only mode)

| SIGNAL | ITEM | SYMBOL | MIN. | TYP. | MAX. | Unit | NOTE |
|-------------------------|-----------------------|----------|------|------|------|--------|--------------|
| Clock | Frequency | $1/T_C$ | 56.4 | 67.3 | 83.0 | MHz | - |
| Hsync | | F_H | 54.2 | 66.0 | 83.8 | kHz | - |
| Vsync | | F_V | 49 | 60 | 75 | Hz | - |
| Vertical Display Term | Active Display Period | T_{VD} | 1080 | 1080 | 1080 | Lines | - |
| | Vertical Total | T_V | 1105 | 1111 | 1118 | Lines | - |
| Horizontal Display Term | Active Display Period | T_{HD} | 960 | 960 | 960 | Clocks | 2pixel/clock |
| | Horizontal Total | T_H | 990 | 1010 | 1040 | clocks | 2pixel/clock |

- Note (1) Test Point : TTL control signal and CLK at LVDS Tx input terminal in system
 (2) Internal Vcc = 5.0V
 (3) While operation, DE signal should be have the same cycle.
 (4) Main frequency Max is 85MHz without spread spectrum.

6.2 Timing diagrams of interface signal (DE only mode)

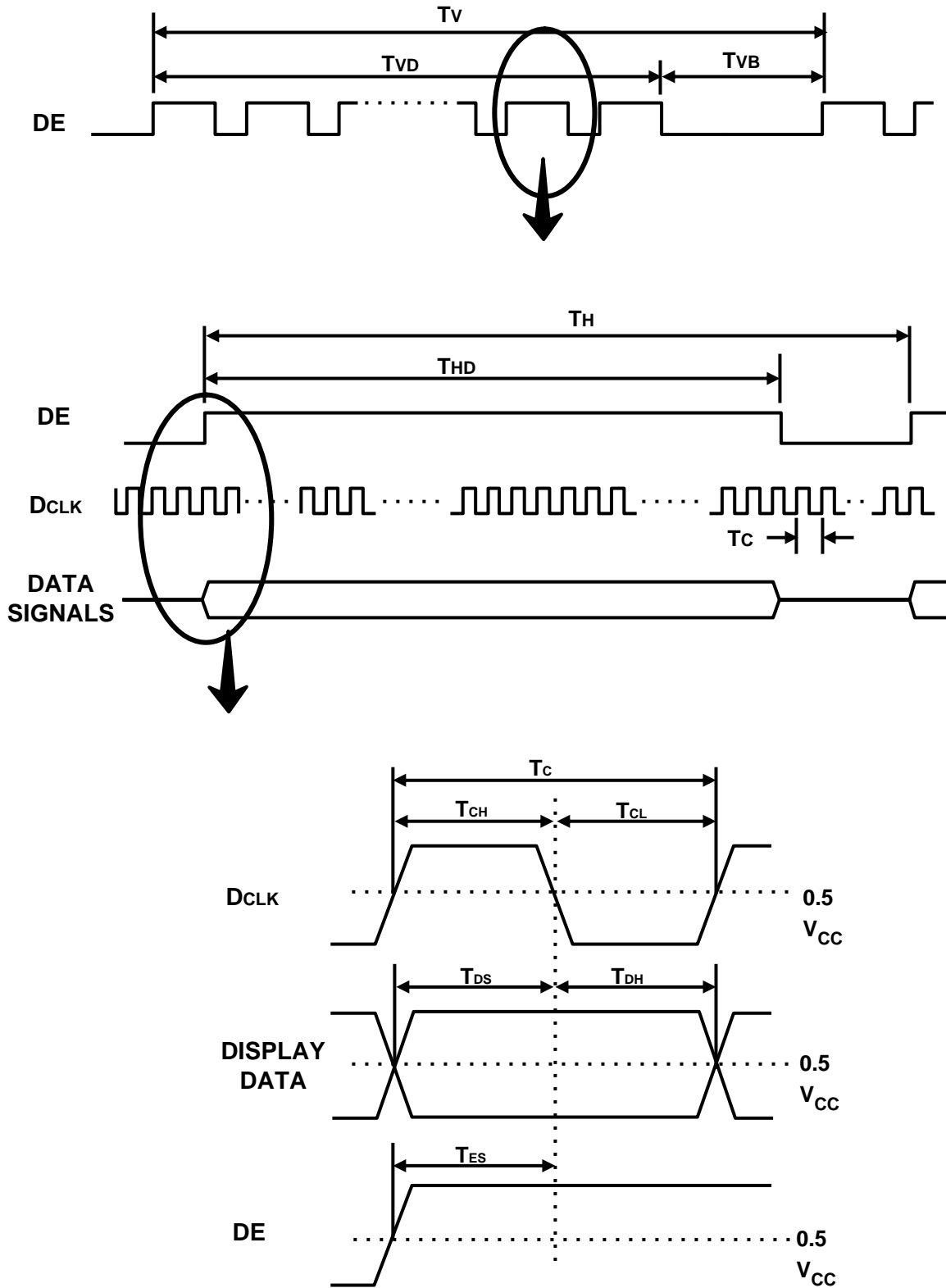

6.3 Power ON/OFF Sequence

To prevent a latch-up or DC operation of the LCD Module, the power on/off sequence should be as the diagram below.

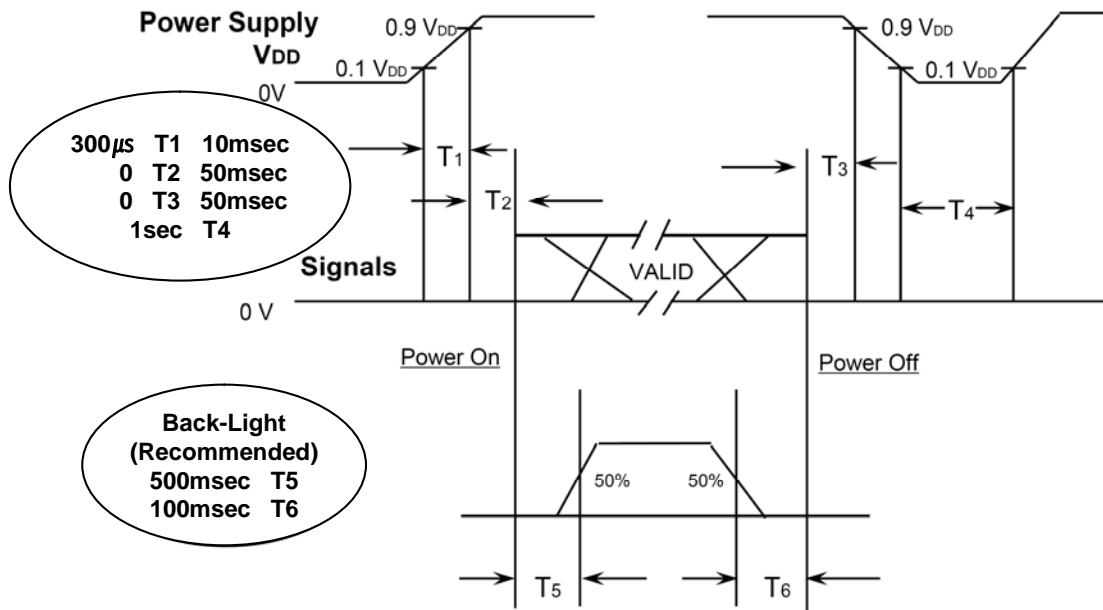

- T_1 : V_{DD} rising time from 10% to 90%
- T_2 : The time from V_{DD} to valid data at power ON.
- T_3 : The time from valid data off to V_{DD} off at power Off.
- T_4 : V_{DD} off time for Windows restart
- T_5 : The time from valid data to B/L enable at power ON.
- T_6 : The time from valid data off to B/L disable at power Off.

- The supply voltage of the external system for the Module input should be the same as the definition of V_{DD} .
- Apply the lamp voltage within the LCD operation range. When the back light turns on before the LCD operation or the LCD turns off before the back light turns off, the display may momentarily show abnormal screen.
- In case of V_{DD} = off level, please keep the level of input signals low or keep a high impedance.
- T_4 should be measured after the Module has been fully discharged between power off and on period.
- Interface signal should not be kept at high impedance when the power is on.

6.4 VDD Power Dip Condition

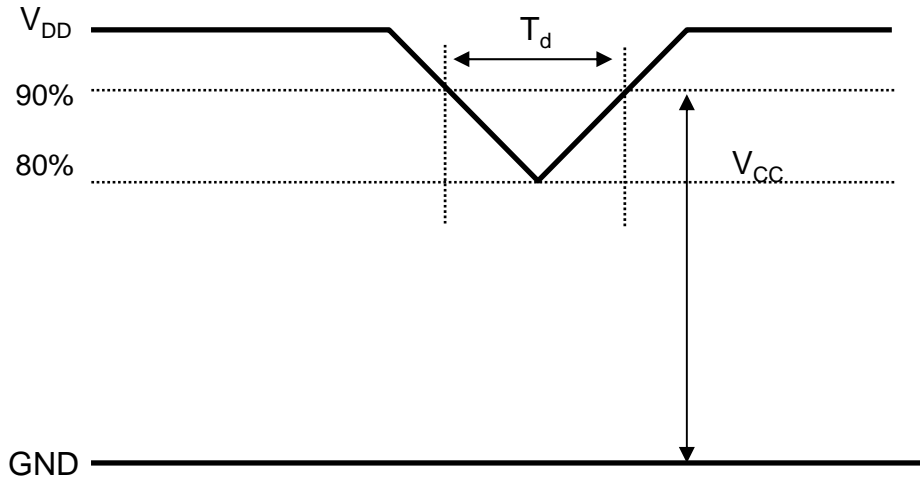

$4.5V$ V_{DD} $5.5V$
 If $V_{DD}(typ.) \times 80\%$ V_{CC} $V_{DD}(typ) \times 90\%$
 Then, $0 < T_d < 20msec$

- Note (1) The above conditions are for the glitch of the input voltage.
 (2) For stable operation of an LCD Module power, please follow them.
 i.e., if $typ\ VDD \times 80\%$ V_{cc} $typ\ VDD \times 90\%$, then T_d should be less than 20ms.

7. Outline Dimension

[Refer to the next page]

PRODUCT INFORMATION

| NO | PART NAME | CODE NO | SPECIFICATION | Q'TY | WEIGHT | FINISH | INFLUENCE OF MATERIAL | REMARK |
|----|-----------|---------|---------------|------|--------|--------|-----------------------|--------|
|----|-----------|---------|---------------|------|--------|--------|-----------------------|--------|

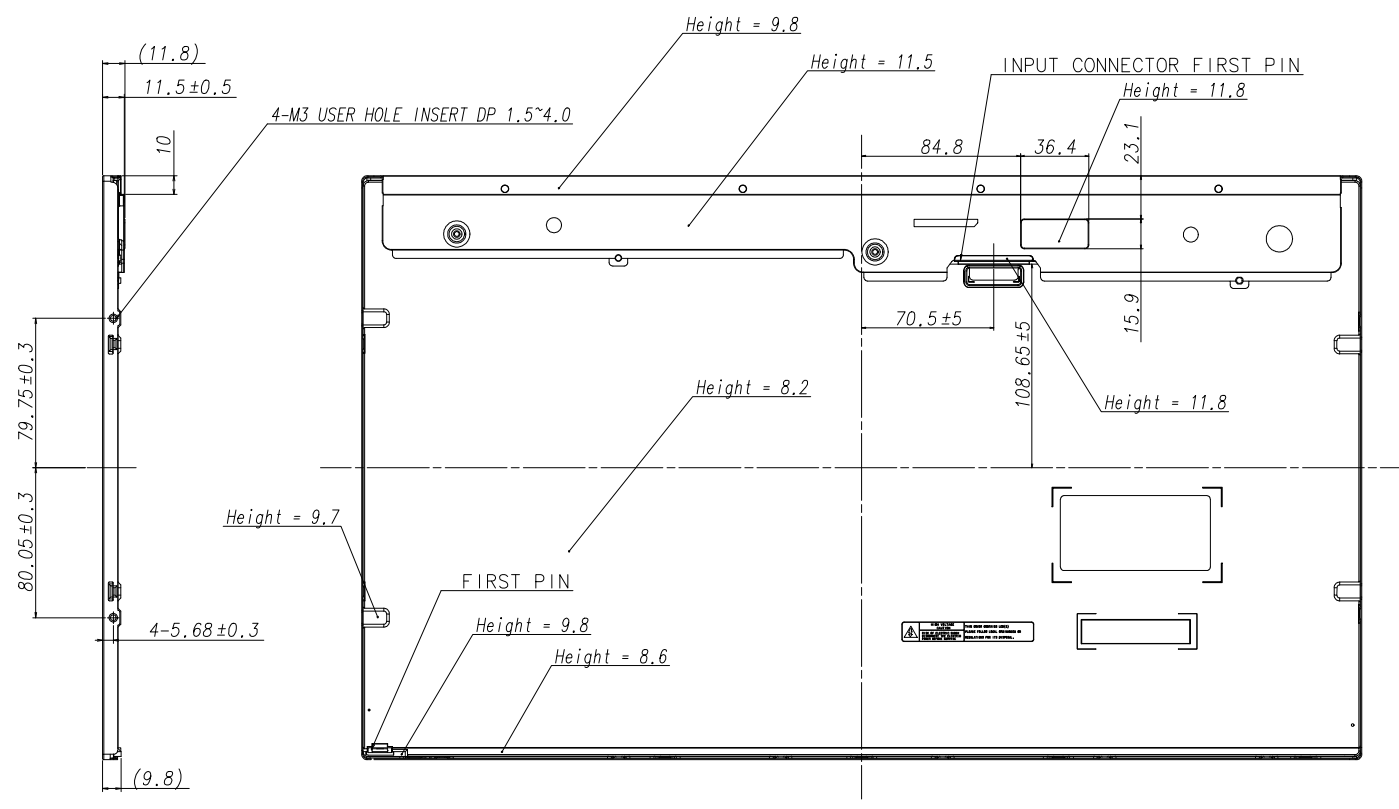
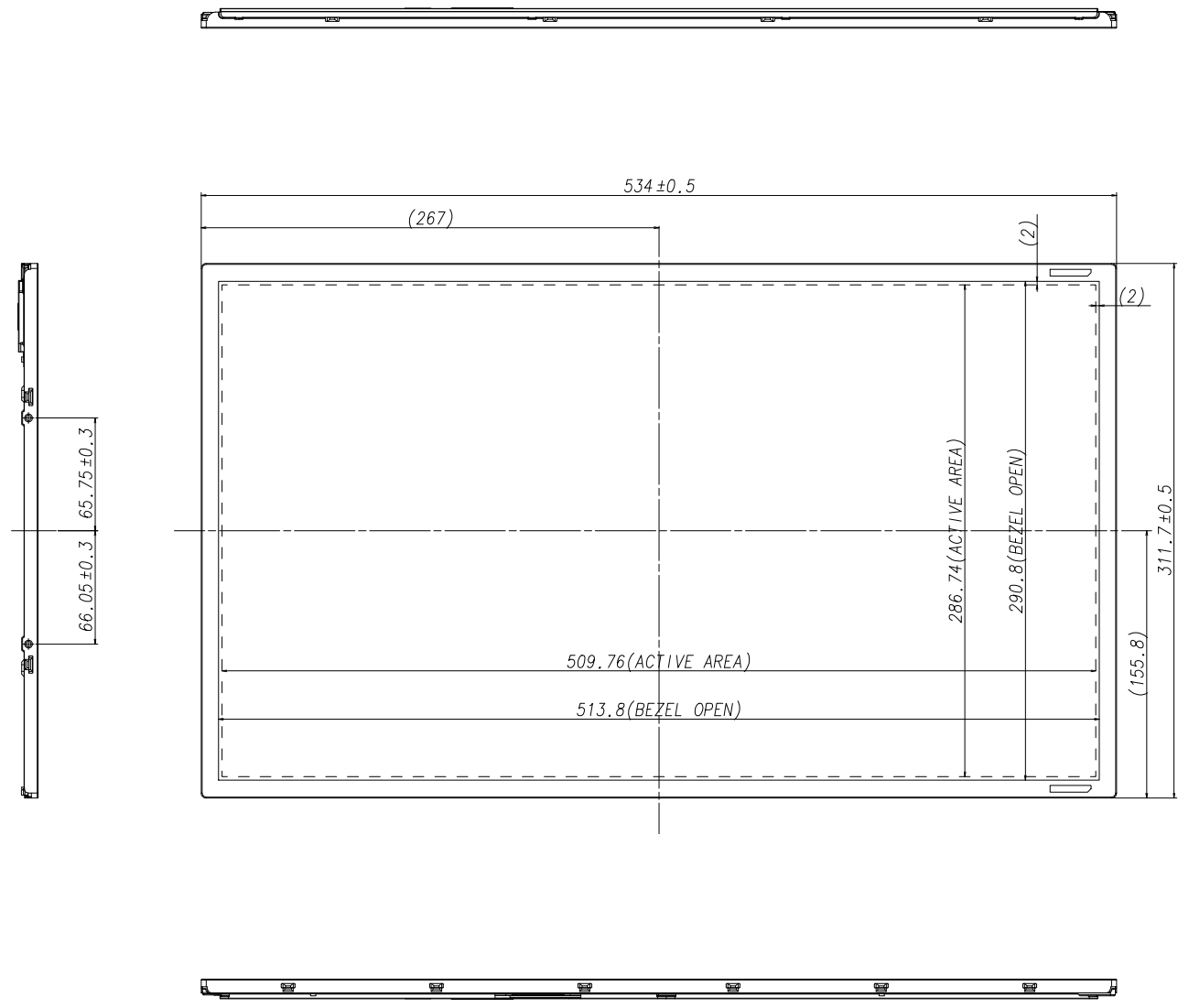

*** NOTES**

- BACKLIGHT : WHITE LED
- I/F CONNECTOR SPEC.
 - MAKER: UJU
 - PART NO.: 1S100-L30B-C23
 or equivalent
- LED CONNECTOR/WIRE SPECIFICATION.
 - MAKER : YEONHO
 - PART NO : 12507WR-06L
 or equivalent
- SCREW TORQUE SPEC : 3 ~ 4 kgf-cm
- BLACK MATRIX SPEC
 - |A - B| ≤ 2.0 mm
 - |C - D| ≤ 2.0 mm

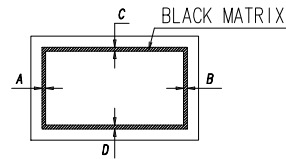

| GENERAL TOLERANCE | | | | REV. DATE | DESCRIPTION OF REVISION | REASON | CHK'D BY |
|-------------------|---------|---------|---------|-----------|-------------------------|------------|----------|
| STEP | LEVEL 1 | LEVEL 2 | LEVEL 3 | UNIT | DRAW'N BY | DES'G'D BY | CHK'D BY |
| 0 < X ≤ 4 | ±0.05 | ±0.1 | ±0.2 | SCALE | / | | |
| 4 < X ≤ 16 | ±0.08 | ±0.15 | ±0.3 | TOLERANCE | JS / K | | |
| 16 < X ≤ 64 | ±0.12 | ±0.25 | ±0.5 | | 2009.11.04 | | |
| 64 < X ≤ 256 | ±0.25 | ±0.4 | ±0.8 | | | | |

| MODEL NAME | PART/SHEET NAME | SHEET |
|------------|-----------------|-------|
| LTM230HT05 | OUTLINE-DIM. | 1/1 |

| SPEC. NO. | CODE NO. | VER. |
|-----------|----------|------|
| | | 03 |

8. General Precautions

8.1 Handling

- (a) When the module is assembled, it should be attached to the system firmly using all mounting holes. Be careful not to twist and bend the module.
- (b) Refrain from strong mechanical shock and / or any force to the module.
In addition to damage, it may cause improper operation or damage to the module and LED back light.
- (c) Note that polarizer films are very fragile and could be damaged easily.
Do not press or scratch the surface harder than a HB pencil lead.
- (d) Wipe off water droplets or oil immediately. If you leave the droplets for a long time, staining or discoloration may occur.
- (e) If the surface of the polarizer is dirty, clean it using absorbent cotton or soft cloth.
- (f) Desirable cleaners are water, IPA (Isopropyl Alcohol) or Hexane.
Do not use Ketone type materials (ex. Acetone), Ethyl alcohol, Toluene, Ethyl acid or Methyl chloride. It might cause permanent damage to the polarizer due to chemical reaction.
- (g) If the liquid crystal material leaks from the panel, it should be kept away from the eyes or mouth . In case of contact with hands, legs or clothes, it must be washed away with soap thoroughly.
- (h) Protect the Module from static, or the CMOS Gate Array IC would be damaged.
- (i) Use finger-stalls with soft gloves in order to keep display clean during the incoming inspection and assembly process.
- (j) Do not disassemble the Module.
- (k) Protection film for polarizer on the Module should be slowly peeled off just before use so that the electrostatic charge can be minimized.
- (l) Pins of I/F connector should not be touched directly with bare hands.

8.2 Storage

- (a) Do not leave the Module in high temperature, and high humidity for a long time. It is highly recommended to store the Module with temperature from 0 to 35 and relative humidity of less than 70%.
- (b) Do not store the TFT-LCD Module in direct sunlight.
- (c) The Module should be stored in a dark place. It is prohibited to apply sunlight or fluorescent light in storing.

8.3 Operation

- (a) Do not connect or disconnect the Module in the "Power On" condition.
- (b) Power supply should always be turned on/off by the item 6.3 "Power on/off sequence"
- (c) Module has high frequency circuits. Sufficient suppression to the electromagnetic interference should be done by system manufacturers. Grounding and shielding methods may be important to minimize the interference.
- (d) The cable between the back light connector and its converter power supply should be connected directly with a minimized length. A longer cable between the back light and the convertor may cause lower luminance of LED

8.4 Operation Condition Guide

- (a) The LCD product should be operated under normal conditions. Normal condition is defined as below;
 - Temperature : 20 ± 15
 - Humidity : $65 \pm 20\%$
 - Display pattern : continually changing pattern (Not stationary)
- (b) If the product will be used in extreme conditions such as high temperature, humidity, display patterns or operation time etc., It is strongly recommended to contact SEC for Application engineering advice. Otherwise, its reliability and function may not be guaranteed. Extreme conditions are commonly found at Airports, Transit Stations, Banks, Stock market, and Controlling systems.

| | | | |
|--------------|------------|------|-------|
| MODEL | LTM230HT05 | Page | 32/33 |
|--------------|------------|------|-------|

8.5 Others

- (a) Ultra-violet ray filter is necessary for outdoor operation.
- (b) Avoid condensation of water. It may result in improper operation or disconnection of electrode.
- (c) Do not exceed the absolute maximum rating value. (supply voltage variation, input voltage variation, variation in part contents and environmental temperature, and so on)
Otherwise the Module may be damaged.
- (d) If the Module keeps displaying the same pattern for a long period of time, the image may be "stuck" to the screen.
To avoid image sticking, it is recommended to use a screen saver.
- (e) This Module has its circuitry PCB's on the rear side and should be handled carefully in order not to be stressed.
- (f) Please contact SEC in advance when you display the same pattern for a long time.