



ISSUED DATE : 07/10/2005

SAMSUNG TFT-LCD PRODUCT INFORMATION
MODEL : LTM201UX-L01

Note : This is Product Information is subject to change after 3 months of issuing date.

LCD Application Engineering 2, TCS Team

Samsung Electronics Co . , LTD.



MODEL	LTM201UX-L01	Page	1/32
-------	--------------	------	------

Contents

PRODUCT INFORMATION

General Description	(3)
1. Absolute Maximum Ratings	(4)
2. Optical Characteristics	(6)
3. Electrical Characteristics	(11)
3.1 TFT LCD Module	
3.2 Back Light Unit	
4. Block Diagram	(16)
4.1 TFT LCD Module	
4.2 Back Light Unit	
5. Input Terminal Pin Assignment	(17)
5.1 Input Signal & Power	
5.2 LVDS Interface	
5.3 Back Light Unit	
5.4 Input Signals, Basic Display Colors and Gray Scale of Each Color	
6. Interface Timing	(24)
6.1 Timing Parameters (DE only mode)	
6.2 Timing Diagrams of interface Signal (DE only mode)	
6.3 Power ON/OFF Sequence	
6.4 LVDS Input Characteristics	
6.5 VDD Power Dip Condition	
7. Outline Dimension	(28)
8. General Precaution	(30)
8.1 Handling	
8.2 Storage	
8.3 Operation	
8.4 Others	

General Description

Description

LTM201UX-L01 is a color active matrix liquid crystal display (LCD) that uses amorphous silicon TFT (Thin Film Transistor) as switching components. This model is composed of a TFT LCD panel, a driver circuit and a back light unit. The resolution of a [20.1"] is [1600 x 1200] and this model can display up to [16.7 millions] colors.

Features

- RoHS compliance (Pb-free)
- TCO'03
- High contrast ratio, high aperture ratio, fast response time
- TN (Twisted Nematic) mode
- 2 dual CCFTs (Cold Cathode Fluorescent Tube)
- DE (Data Enable) mode
- LVDS (Low Voltage Differential Signaling) interface (2pixel/clock)
- COMPACT SIZE DESIGN

Applications

- Workstation & desktop monitors
 - Display terminals for AV application products
 - Monitors for industrial machine
- * If the module is used to other applications besides the above, please contact SEC in advance.

General Information

Items	Specification	Unit	Note
Pixel Pitch	0.255(H) x 0.255(W)	mm	
Active Display Area	408(H) x 306(V)	mm	
Surface Treatment	Haze 44% , Hard-coating (3H)		
Display Colors	16.7M (6bits + Hi-FRC)	colors	
Number of Pixels	1600 x 1200	pixel	
Pixel Arrangement	RGB vertical stripe		
Display Mode	Normally White		
Power Consumption	25.5 Watt (Typ.)		
Luminance of White	300(Typ.)	cd/m ²	

Mechanical Information

Item		Min.	Typ.	Max.	Unit	Note
Module size	Horizontal (H)	431.5	432.0	432.5	mm	w/o inverter ass'y
	Vertical (V)	331.0	331.5	332.0	mm	
	Depth (D)	-	-	25.5	mm	
Weight		-	-	3250	g	LCD module only
		-	-	-	g	w/ Inverter assembly

Note (1) Mechanical tolerance is $\pm 0.5\text{mm}$ unless there is a special comment.

1. Absolute Maximum Ratings

If the condition exceeds maximum ratings, it can cause malfunction or unrecoverable damage to the device.

Item		Symbol	Min.	Max.	Unit	Note
Power Supply Voltage		V_{DD}	GND-0.5	6.5	V	(1)
Data Signal		V_{sig}	-	5	V	
Storage temperature		T_{STG}	-25	60		(2)
Glass surface temperature (Operation)	Center	T_{OPR}	0	50		(2),(5)
	T. Uniformity	T	-	10		
Shock (non - operating)		S_{nop}	-	50	G	(3)
Vibration (non - operating)		V_{nop}	-	1.0	G	(4)

Note (1) $T_a = 25 \pm 2 \text{ }^\circ\text{C}$

- (2) Temperature and relative humidity range are shown in the figure below.
 - a. 90 % RH Max. (Ta 39 °C)
 - b. Maximum wet-bulb temperature at 39 °C or less. (Ta 39 °C)
 - c. No condensation
- (3) 11ms, sine wave, one time for ±X, ±Y, ±Z axis
- (4) 10-300 Hz, Sweep rate 10min, 30min for X,Y,Z axis

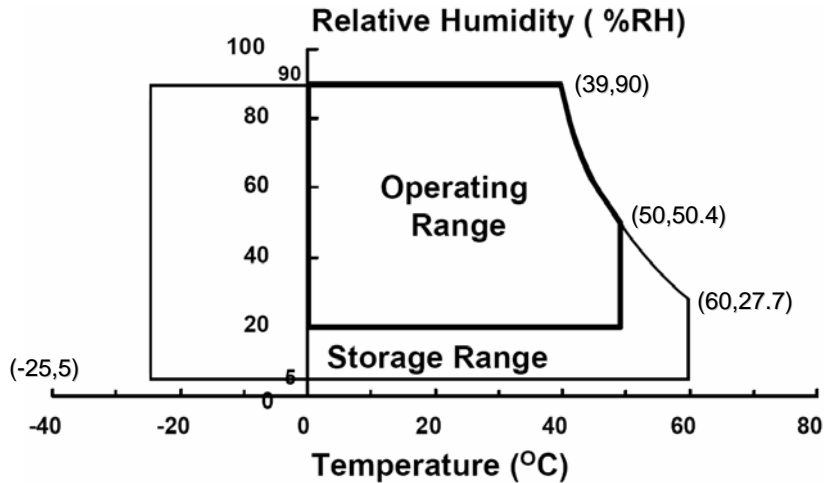
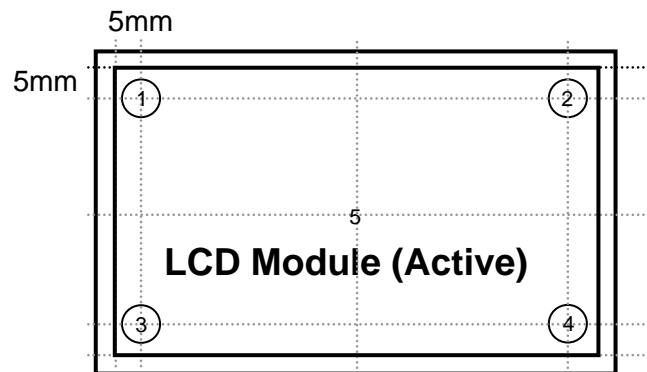

Fig. Temperature and Relative humidity range

- (5) Definition of test point



T should be less than 10 ($T = |T_{OPR} - T_{MAX}|$)

T_{OPR} : Temperature of the center of the glass surface (Test point 5)
 T1~ T4 : Temperature of each edge of the glass surface
 T_{MAX} : The highest temperature of the glass surface

2. Optical Characteristics

PRODUCT INFORMATION

The optical characteristics should be measured in a dark room or equivalent.

Measuring equipment : TOPCON BM-7,SPECTRORADIOMETER SR-3

(Ta = 25 ± 2°C, VDD=5V, fv= 60Hz, fDCLK=65.2MHz, IL = 7..5mArms)

Item	Symbol	Condition	Min.	Typ.	Max.	Unit	Note	
Contrast Ratio (Center of screen)	C/R	Normal L,R=0 u,D=0 Viewing Angle	500	800	-		(3) SR-3	
Response Time	Rising		Tr	-	1.0	3.0	msec	(5) BM-7
	Falling		Tf	-	4.0	8.0		
Luminance of White (Center of screen)	Y _L			250	300	-	cd/m ²	(6) SR-3
Color Chromaticity (CIE 1931)	Red		Rx	0.610	0.640	0.670		(7),(8) SR-3
			Ry	0.300	0.330	0.360		
	Green		Gx	0.270	0.300	0.330		
			Gy	0.570	0.600	0.630		
	Blue		Bx	0.120	0.150	0.180		
			By	0.020	0.060	0.090		
	White		Wx	0.283	0.313	0.343		
			Wy	0.299	0.329	0.359		
Color Chromaticity (CIE 1976)	Red		Ru'	-	0.451	-		
			Rv'	-	0.523	-		
	Green	Gu'	-	0.125	-			
		Gv'	-	0.563	-			
	Blue	Bu'	-	0.175	-			
		Bv'	-	0.158	-			
	White	Wu'	-	0.198	-			
		Wv'	-	0.468	-			
C.G.L (ACC ONLY)	White	u'v'	-	0.018	-		(9)	

* C.G.L : Color Grayscale Linearity

(continue to the next page)

PRODUCT INFORMATION

Item	Symbol	Condition	Min.	Typ.	Max.	Unit	Note	
Color Gamut	-		-	72	-	%		
Color Temperature	-		-	6500	-	K		
Viewing Angle	Hor.	L	CR 10	70	80	-	Degrees	(8) SR-3
		R		70	80	-		
	Ver.	U		70	80	-		
		D		70	80	-		
Brightness Uniformity (9 Points)	B _{uni}		-	-	25	%	(4) SR-3	

Note (1) Test Equipment Setup

The measurement should be executed in a stable, windless and dark room between 30min after lighting the back light at the given temperature for stabilization of the back light. This should be measured in the center of screen.

Single lamp current : 6.5mA

Environment condition : Ta = 25 ± 2 °C

Photo detector	Field
SR-3	1 °
BM-7	2 °

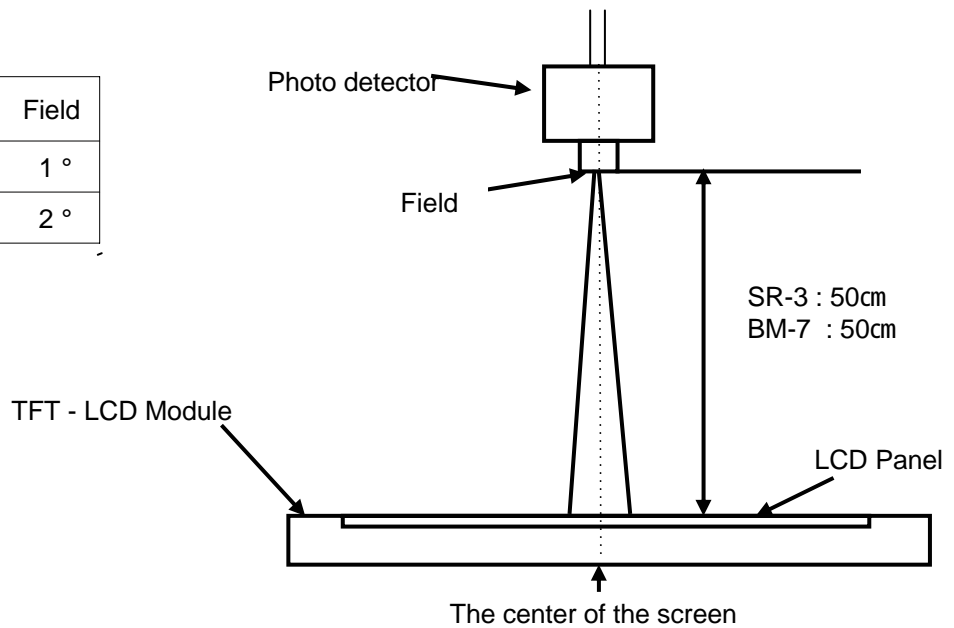

Note (2) Definition of test point

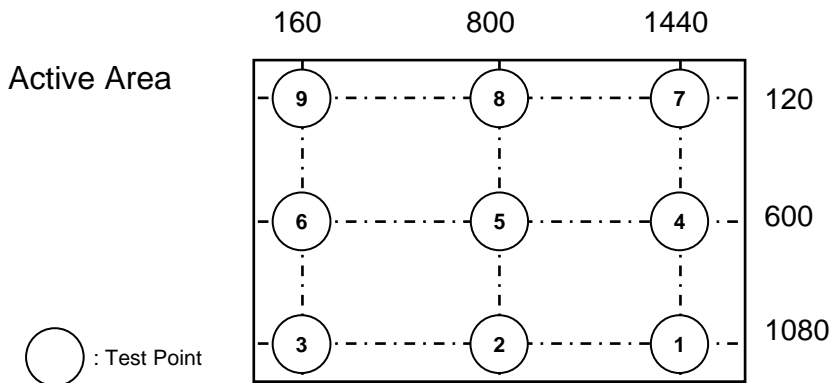

Note (3) Definition of Contrast Ratio (C/R)

: Ratio of gray max (Gmax) & gray min (Gmin) at the center point of the panel

$$CR = \frac{G \text{ max}}{G \text{ min}}$$

Gmax : Luminance with all pixels white

Gmin : Luminance with all pixels black

Note (4) Definition of 9 points brightness uniformity

$$Buni = 100 \times \frac{(B \text{ max} - B \text{ min})}{B \text{ max}}$$

Bmax : Maximum brightness

Bmin : Minimum brightness

Note (5) Definition of Response time : Sum of Tr, Tf

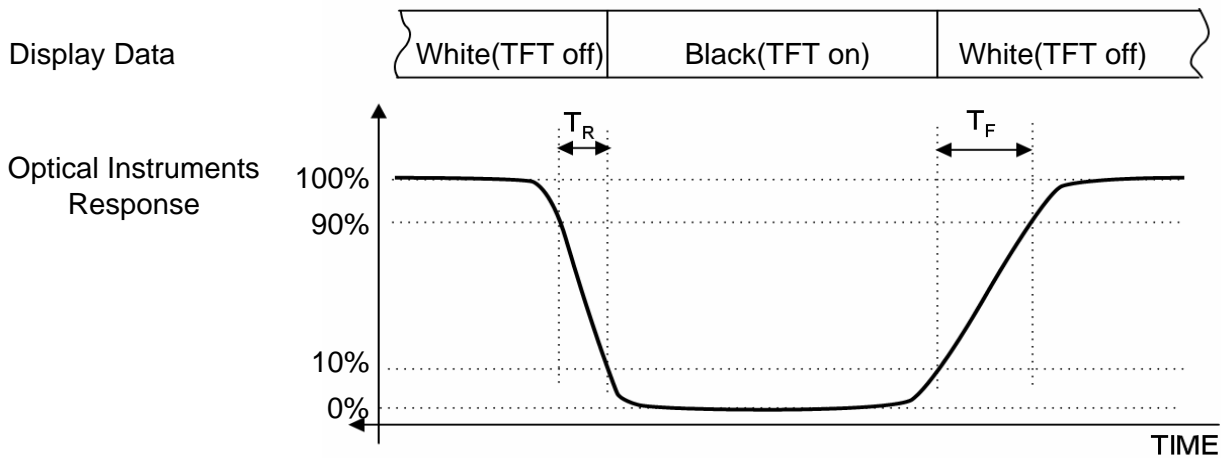

PRODUCT INFORMATION

Note (6) Definition of Luminance of White : Luminance of white at center point

Note (7) Definition of Color Chromaticity (CIE 1931, CIE1976)
Color coordinate of Red, Green, Blue & White at center point

Note (8) Definition of Viewing Angle
: Viewing angle range (CR 10)

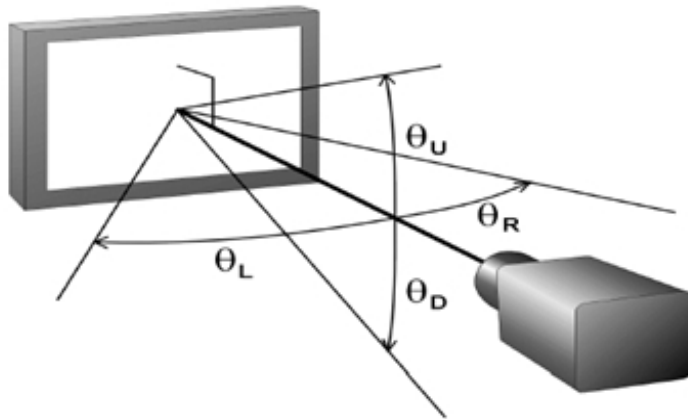

Note (9) Color Grayscale Linearity

a. Test image : 100% full white pattern with a test pattern as below

b. Test pattern : Squares, 40mm by 40mm in size, filled with 255, 225, 195, 165, 135 and 105 grays steps should be arranged at the center of the screen.



c. Test method

-1st gray step : move a square of 255 gray level should be moved into the center of the screen and measure luminance and u' and v' coordinates.

- Next gray step : Move a 225 gray square into the center and measure both luminance and coordinates, too.

d. Test evaluation

$$\Delta u' v' = \sqrt{(u'_A - u'_B)^2 + (v'_A - v'_B)^2}$$

Where A, B : 2 gray levels found to have the largest color differences between them

i.e. get the largest u' and v' of each 6 pair of u' and v' and calculate the $u'v'$.

3. Electrical Characteristics

3.1 TFT LCD Module

The connector for display data & timing signal should be connected.

Ta = 25°C

Item	Symbol	Min.	Typ.	Max.	Unit	Note	
Voltage of Power Supply	V_{DD}	4.5	5.0	5.5	V	(1)	
LVDS Input Characteristics	Differential Input Voltage for LVDS Receiver Threshold	High	-	-	+100	mV	(2)
		Low	-100	-	-	mV	
	LVDS skew	t_{SKEW}	-380		380		(3)
	Differential input voltage	$ V_{ID} $	200		600	mV	(4)
	Input voltage range (single-ended)	V_{IN}	0		2.4	V	(4)
	Common mode voltage	V_{CM}	0+ $ V_{ID} /2$	1.2	2.4- $ V_{ID} /2$	V	(4)
	Input current	I_{IN}			± 10	μA	(5)
Current of Power Supply	(a) Black	I_{DD}	-	900	1200	mA	(6),(7)
	(b) White		-	650	800	mA	
	(c) Dot		-	1200	1500	mA	
Vsync Frequency	f_V	50	60	75	Hz		
Hsync Frequency	f_H	61.7	74.1	93.2	kHz		
Main Frequency	f_{DCLK}	54.4	65.2	85.0	MHz		
Rush Current	I_{RUSH}	-	-	4.0	A	(8)	

Note (1) The ripple voltage should be controlled under 10% of V_{DD} .

(2) Differential receiver voltage definitions and propagation delay and transition time test circuit

- a. All input pulses have frequency = 10MHz, t_R or $t_F=1ns$
- b. C_L includes all probe and fixture capacitance

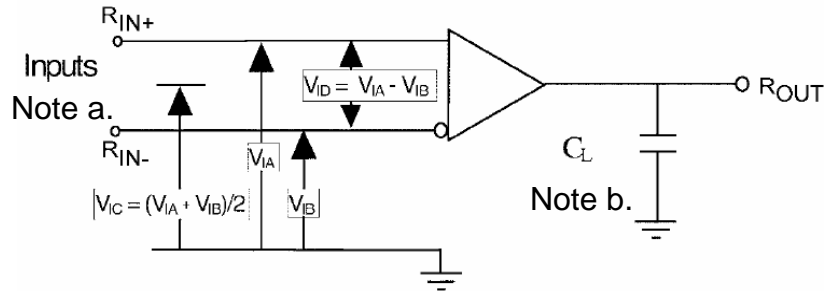

(3) LVDS Receiver DC parameters are measured under static and steady conditions which may not be reflective of its performance in the end application.

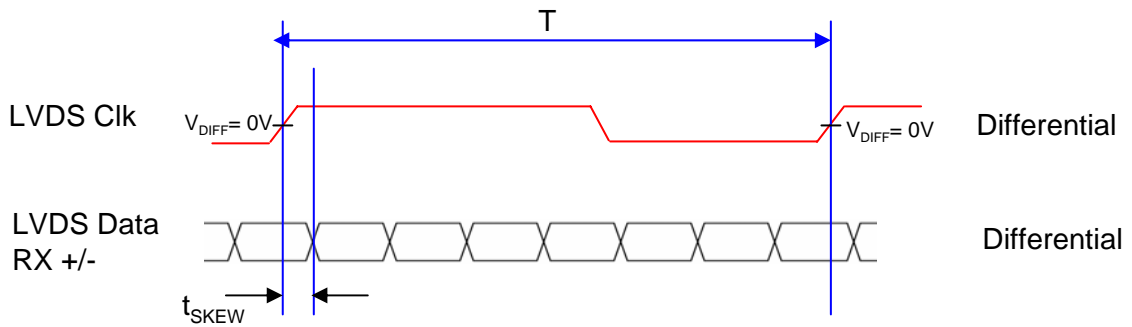

where t_{skew} : skew between LVDS clock & LVDS data,

T : 1 period time of LVDS clock

cf) (-/+) of 380psec means LVDS data goes before or after LVDS clock.

(4) Definition of V_{ID} and V_{CM} using single-end signals

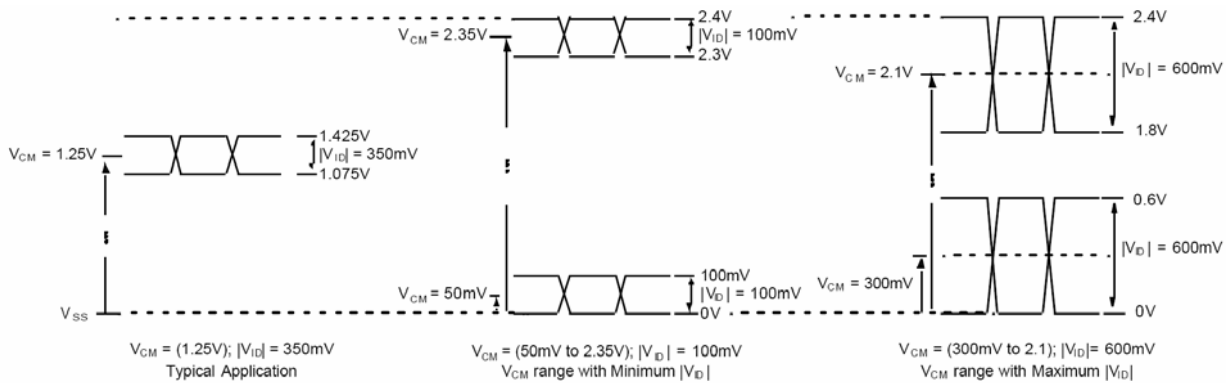

PRODUCT INFORMATION

- (5) Measurement Conditions condition $V_{IN}=2.4V$, $V_{DD}=3.6V$, $V_{IN}=0V$, $V_{DD}=3.6V$
- (6) $f_V=60Hz$, $f_{DCLK} = 65.2MHz$, $V_{DD} = 5.0V$, DC Current.
- (7) Power dissipation check pattern (LCD Module only)

a) Black Pattern

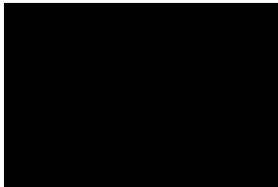

b) White Pattern



c) Dot Pattern

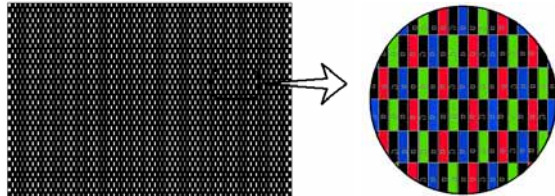

- (8) Measurement Conditions condition $V_{IN}=2.4V$, $V_{DD}=3.6V$, $V_{IN}=0V$, $V_{DD}=3.6V$

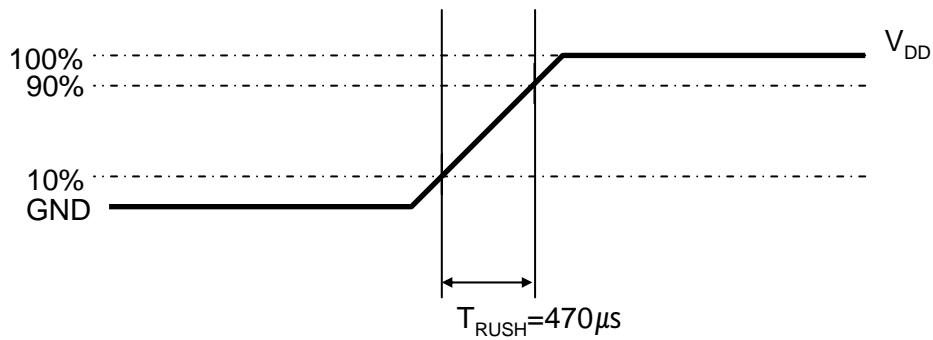

Rush Current I_{RUSH} can be measured when T_{RUSH} is $470 \mu s$.

3.2 Back Light Unit

The back light unit is an edge - lighting type with 2 dual CCFTs (Cold Cathode Fluorescent Tube) The characteristics of two dual lamps are shown in the following tables.

Ta=25 ± 2°C

Item	Symbol	Min.	Typ.	Max.	Unit	Note	
Lamp Current	I_L	3.0	7.5	8.0	mArms	(1)	
Lamp Current Uniformity	I_{UNI}	-	-	25	%	(2)	
Lamp Voltage	V_L	-	650	-	Vrms		
Lamp Frequency	f_L	40	-	60	kHz	(3)	
Operating Life Time	Hr	50,000	-	-	Hour	(4)	
Inverter waveform	Asymmetry rate	Wasy	-	-	10	%	(5)
	Distortion rate	Wdis	1.2726	1.414	1.5554		
Startup Voltage	V_s	-	-	0 : 1,750	Vrms	(6)	
				25 : 1,450			

Note (1) Specified values are for a single lamp.

Lamp current is measured with current meter for high frequency as shown below.
Refer to the following block diagram of the back light unit for more information.

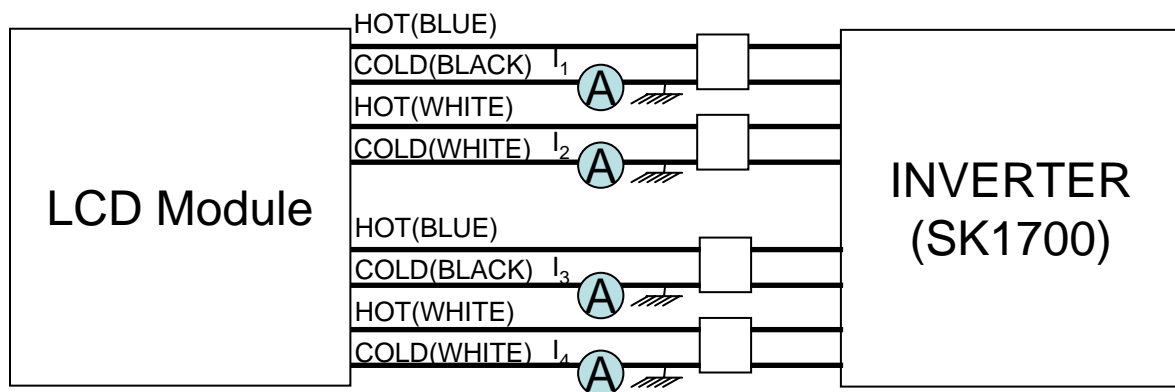

Fig. Measurement point of Lamp Current

(2) Define of Lamp current uniformity : I_{UNI}

$$I_{UNI} = \frac{|I_{Max} - I_{Min}|}{I_{Max}} \times 100$$

I_{max} : Maximum lamp current

I_{min} : Minimum lamp current

Lamp current uniformity I_{UNI} should be less than 25%

(3) Lamp frequency which may produce interference with horizontal synchronous frequency may cause line flow on the display. Therefore lamp frequency should be detached from the horizontal synchronous frequency and its harmonics as far as possible in order to avoid interference.

(4) Life time (Hr) is defined as the time when brightness of a lamp unit itself becomes 50% or less than its original value at the condition of $T_a = 25 \pm 2^\circ\text{C}$ and $I_L = 7.5\text{mA}_{rms}$

(5) Designing a system inverter intended to have better display performance, power efficiency and lamp reliability.

They would help increase the lamp lifetime and reduce leakage current.

- a. The measurement should be done at typical lamp current.
- b. The asymmetry rate of the inverter waveform should be less than 10%.
- c. The distortion rate of the waveform should be 2 with $\pm 10\%$ tolerance.
 - Inverter output waveform had better be more similar to ideal sine wave.

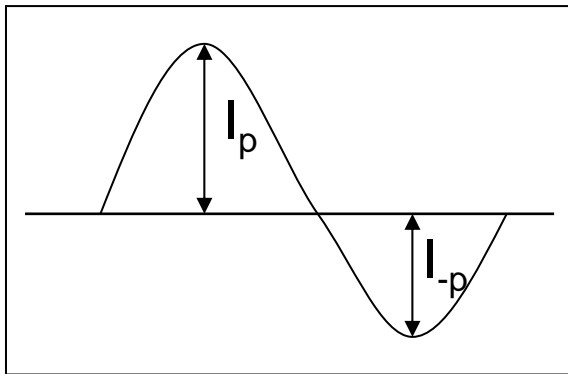

Fig. Wave form of the inverter

- Asymmetry rate

$$\frac{|I_p - I - p|}{I_{rms}} \times 100$$

- Distortion rate

$$\left| \frac{I_p}{I_{rms}} \right| \text{ or } \left| \frac{I - p}{I_{rms}} \right|$$

(6) If an inverter has shutdown function, it should keep its output for over 1 second even if the lamp connector is open. Otherwise the lamps may not be turned on.

4. BLOCK DIAGRAM

4.1 TFT LCD Module

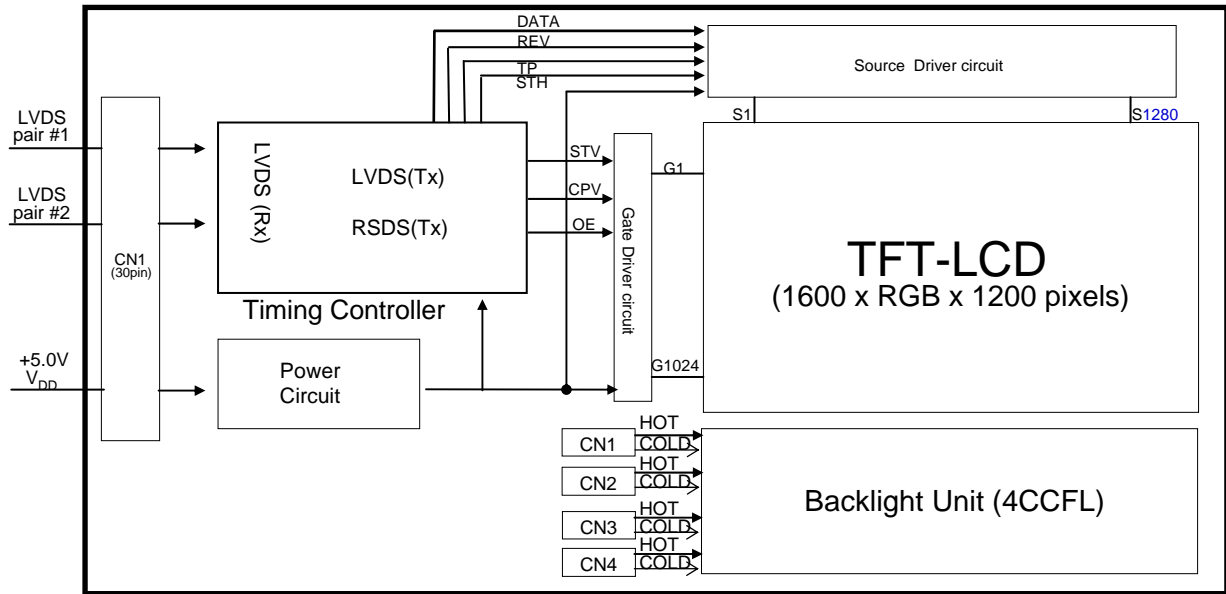

4.2 Back Light Unit

Connector: YEON-HO 35002WR-04L

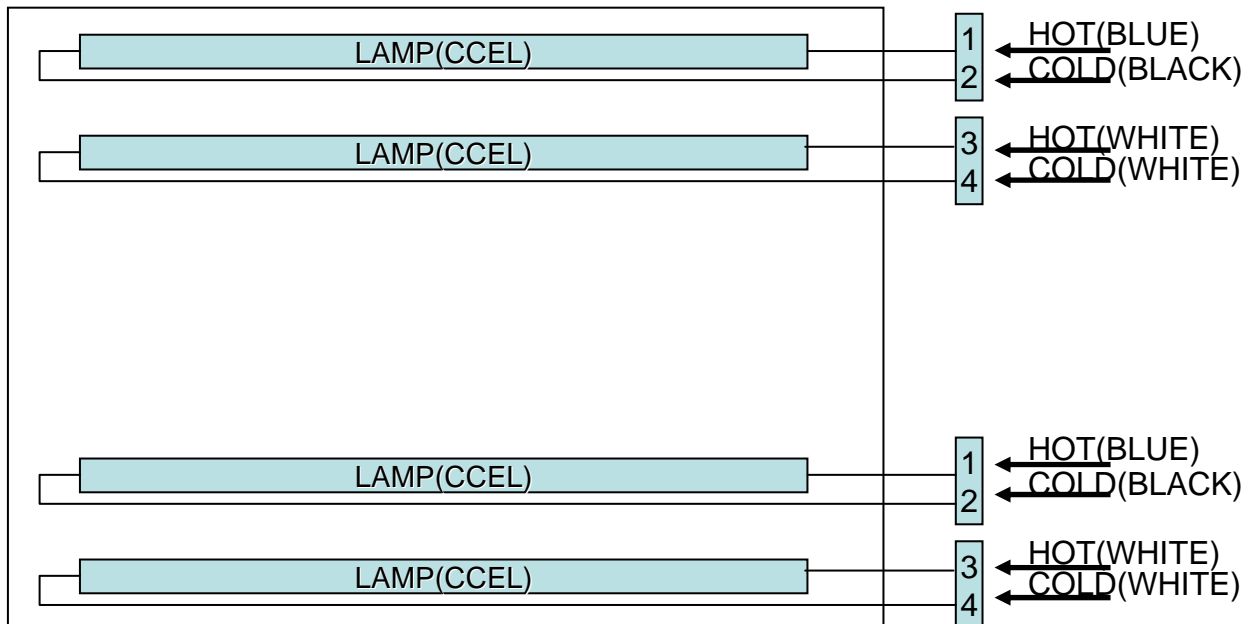

5. Input Terminal Pin Assignment

5.1. Input Signal & Power (Connector : UJU IS100-L300-C23 or Compatible)

PIN NO	SYMBOL	FUNCTION
1	V_{DD}	Power Supply : +5V
2	V_{DD}	
3	V_{DD}	
4	NC	No Connection
5	NC	No Connection
6	NC	No Connection
7	GND	Power Ground
8	RXE3+	Positive Transmission Data of Pixel 3 (EVEN data)
9	RXE3-	Negative Transmission Data of Pixel 3 (EVEN data)
10	RXEC+	Positive Sampling Clock (EVEN data)
11	RXEC-	Negative Sampling Clock (EVEN data)
12	RXE2+	Positive Transmission Data of Pixel 2 (EVEN data)
13	RXE2-	Negative Transmission Data of Pixel 2 (EVEN data)
14	GND	Power Ground
15	RXE1+	Positive Transmission Data of Pixel 1 (EVEN data)
16	RXE1-	Negative Transmission Data of Pixel 1 (EVEN data)
17	GND	Power Ground
18	RXE0+	Positive Transmission Data of Pixel 0 (EVEN data)
19	RXE0-	Negative Transmission Data of Pixel 0 (EVEN data)
20	RXO3+	Positive Transmission Data of Pixel 3 (ODD data)
21	RXO3-	Negative Transmission Data of Pixel 3 (ODD data)
22	RXOC+	Positive Sampling Clock (ODD data)
23	RXOC-	Negative Sampling Clock (ODD data)
24	GND	Power Ground
25	RXO2+	Positive Transmission Data of Pixel 2 (ODD data)
26	RXO2-	Negative Transmission Data of Pixel 2 (ODD data)
27	RXO1+	Positive Transmission Data of Pixel 1 (ODD data)
28	RXO1-	Negative Transmission Data of Pixel 1 (ODD data)
29	RXO0+	Positive Transmission Data of Pixel 0 (ODD data)
30	RXO0-	Negative Transmission Data of Pixel 0 (ODD data)

* If the system already uses the 5, 6pins, it should keep under GND level
The voltage applied to those pins should not exceed -200mV.

Note) Pin number starts from Right side

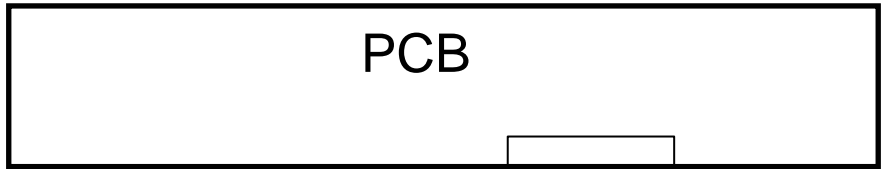

Pin No. 30 Pin No. 1



connect name



Fig. Connector diagram

- a. All GND pins should be connected together and also be connected to the LCD's metal chassis.
- b. All power input pins should be connected together.
- c. All NC pins should be separated from other signal or power.

5.2 LVDS Interface

5.2.1 Odd Pixel Data (1st pixel data)

1st LVDS Transmitter (DS90C383, DS90C385) Signal Interface						
Device Input Pin		Device Input Signal		Output Signal	To LTM170EU Interface (CN101)	
No	Symbol	Symbol	Function		Terminal	Symbol
51	TXIN0	RO0	Red Odd Pixel Data (LSB)	TXOUT0- TXOUT0+	No. 1 No. 2	RXO0- RXO0+
52	TXIN1	RO1	Red Odd Pixel Data			
54	TXIN2	RO2	Red Odd Pixel Data			
55	TXIN3	RO3	Red Odd Pixel Data			
56	TXIN4	RO4	Red Odd Pixel Data			
2	TXIN5	RO7	Red Odd Pixel Data (MSB)	TXOUT3- TXOUT3+	No. 10 No. 11	RXO3- RXO3+
3	TXIN6	RO5	Red Odd Pixel Data	TXOUT0- TXOUT0+	No. 1 No. 2	RXO0- RXO0+
4	TXIN7	GO0	Green Odd Pixel Data (LSB)			
6	TXIN8	GO1	Green Odd Pixel Data	TXOUT1- TXOUT1+	No. 3 No. 4	RXO1- RXO1+
7	TXIN9	GO2	Green Odd Pixel Data			
8	TXIN10	GO6	Green Odd Pixel Data	TXOUT3- TXOUT3+	No. 10 No. 11	RXO3- RXO3+
10	TXIN11	GO7	Green Odd Pixel Data (MSB)			
11	TXIN12	GO3	Green Odd Pixel Data	TXOUT1- TXOUT1+	No. 3 No. 4	RXO1- RXO1+
12	TXIN13	GO4	Green Odd Pixel Data			
14	TXIN14	GO5	Green Odd Pixel Data			
15	TXIN15	BO0	Blue Odd Pixel Data (LSB)			
16	TXIN16	BO6	Blue Odd Pixel Data	TXOUT3- TXOUT3+	No. 10 No. 11	RXO3- RXO3+
18	TXIN17	BO7	Blue Odd Pixel Data (MSB)			
19	TXIN18	BO1	Blue Odd Pixel Data	TXOUT1- TXOUT1+	No. 3 No. 4	RXO1- RXO1+
20	TXIN19	BO2	Blue Odd Pixel Data	TXOUT2- TXOUT2+	No. 5 No. 6	RXO2- RXO2+
22	TXIN20	BO3	Blue Odd Pixel Data			
23	TXIN21	BO4	Blue Odd Pixel Data			
24	TXIN22	BO5	Blue Odd Pixel Data			
50	TXIN27	RO6	Red Odd Pixel Data	TXOUT3- TXOUT3+	No. 10 No. 11	RXO3- RXO3+

5.2.2 Even Pixel Data (2nd pixel data)

2nd LVDS Transmitter (DS90C383 , DS90C385) Signal Interface						
Device Input Pin		Device Input Signal		Output Signal	To LTM170EU Interface (CN101)	
No	Symbol	Symbol	Function		Terminal	Symbol
51	TXIN0	RE0	Red Even Pixel Data (LSB)	TXOUT0- TXOUT0+	No. 12 No. 13	RXE0- RXE0+
52	TXIN1	RE1	Red Even Pixel Data			
54	TXIN2	RE2	Red Even Pixel Data			
55	TXIN3	RE3	Red Even Pixel Data			
56	TXIN4	RE4	Red Even Pixel Data			
2	TXIN5	RE7	Red Even Pixel Data (MSB)	TXOUT3- TXOUT3+	No. 22 No. 23	RXE3- RXE3+
3	TXIN6	RE5	Red Even Pixel Data	TXOUT0- TXOUT0+	No. 12 No. 13	RXE0- RXE0+
4	TXIN7	GE0	Green Even Pixel Data (LSB)			
6	TXIN8	GE1	Green Even Pixel Data	TXOUT1- TXOUT1+	No. 15 No. 16	RXE1- RXE1+
7	TXIN9	GE2	Green Even Pixel Data			
8	TXIN10	GE6	Green Even Pixel Data	TXOUT3- TXOUT3+	No. 22 No. 23	RXE3- RXE3+
10	TXIN11	GE7	Green Even Pixel Data (MSB)			
11	TXIN12	GE3	Green Even Pixel Data	TXOUT1- TXOUT1+	No. 15 No. 16	RXE1- RXE1+
12	TXIN13	GE4	Green Even Pixel Data			
14	TXIN14	GE5	Green Even Pixel Data			
15	TXIN15	BE0	Blue Even Pixel Data (LSB)	TXOUT3- TXOUT3+	No. 22 No. 23	RXE3- RXE3+
16	TXIN16	BE6	Blue Even Pixel Data			
18	TXIN17	BE7	Blue Even Pixel Data (MSB)			
19	TXIN18	BE1	Blue Even Pixel Data	TXOUT1- TXOUT1+	No. 15 No. 16	RXE1- RXE1+
20	TXIN19	BE2	Blue Even Pixel Data	TXOUT2- TXOUT2+	No. 18 No. 19	RXE2- RXE2+
22	TXIN20	BE3	Blue Even Pixel Data			
23	TXIN21	BE4	Blue Even Pixel Data			
24	TXIN22	BE5	Blue Even Pixel Data	TXOUT3- TXOUT3+	No. 22 No. 23	RXE3- RXE3+
50	TXIN27	RE6	Red Even Pixel Data			

5.2.3 Timing Diagrams of LVDS For Transmitting
 LVDS Receiver : Integrated T-CON

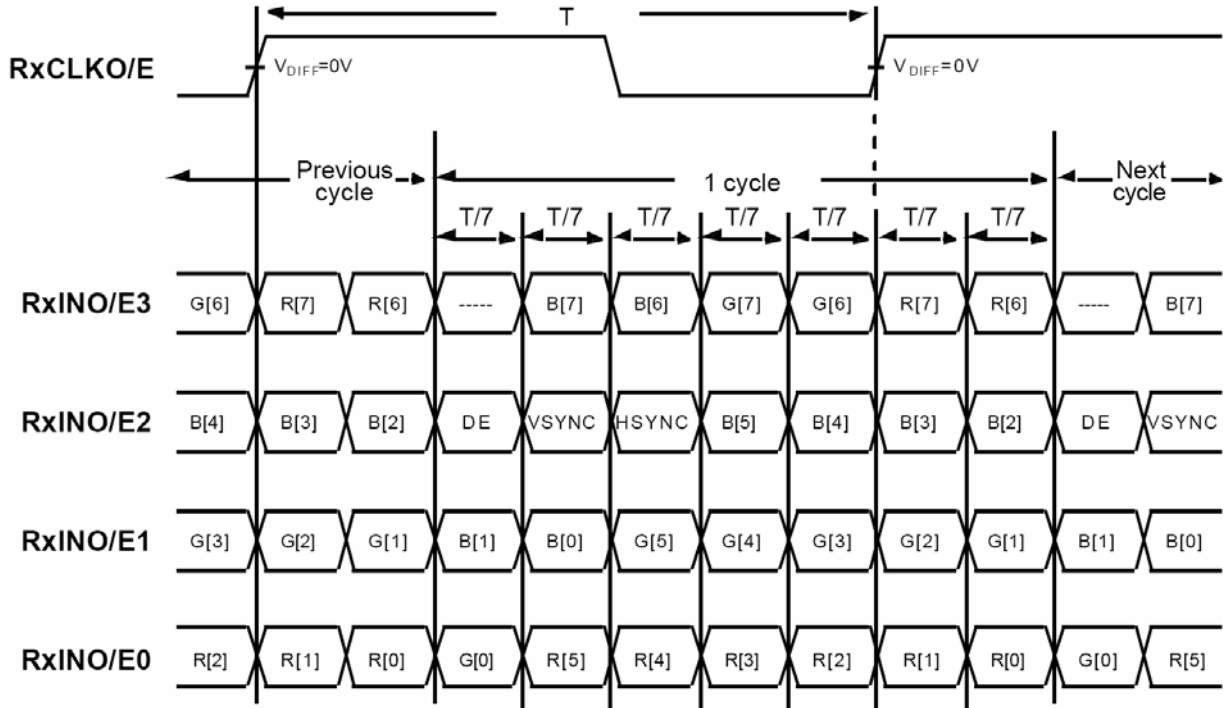

5.3 Back Light Unit

	Pin No.	Input	Color	Function
Upper	1	Hot1	Blue	High Voltage
	2	Cold1	Black	Ground
	3	Hot2	White	High Voltage
	4	Cold2	White	Ground
Lower	1	Hot1	Blue	High Voltage
	2	Cold1	Black	Ground
	3	Hot2	White	High Voltage
	4	Cold2	White	Ground
	Connect or Part No.	YEON-HO 35002WR-04L or equivalent		

5.4 Input Signals, Basic Display Colors and Gray Scale of Each Color

COLO R	DISPLAY (8bit)	DATA SIGNAL																					GRAY SCALE LEVEL			
		RED							GREEN							BLUE										
		R0	R1	R2	R3	R4	R5	R6	R7	G0	G1	G2	G3	G4	G5	G6	G7	B0	B1	B2	B3	B4		B5	B6	B7
BASIC COLO R	BLACK	0	0	0	0	0	0	0	0	0	0	0	0	0	0	0	0	0	0	0	0	0	0	0	0	-
	BLUE	0	0	0	0	0	0	0	0	0	0	0	0	0	0	0	0	1	1	1	1	1	1	1	1	-
	GREEN	0	0	0	0	0	0	0	0	1	1	1	1	1	1	1	1	0	0	0	0	0	0	0	0	-
	CYAN	0	0	0	0	0	0	0	0	1	1	1	1	1	1	1	1	1	1	1	1	1	1	1	1	-
	RED	1	1	1	1	1	1	1	1	0	0	0	0	0	0	0	0	0	0	0	0	0	0	0	0	-
	MAGENTA	1	1	1	1	1	1	1	1	0	0	0	0	0	0	0	0	1	1	1	1	1	1	1	1	-
	YELLOW	1	1	1	1	1	1	1	1	1	1	1	1	1	1	1	1	0	0	0	0	0	0	0	0	-
	WHITE	1	1	1	1	1	1	1	1	1	1	1	1	1	1	1	1	1	1	1	1	1	1	1	1	-
GRAY SCALE OF RED	BLACK	0	0	0	0	0	0	0	0	0	0	0	0	0	0	0	0	0	0	0	0	0	0	0	R0	
	DARK	1	0	0	0	0	0	0	0	0	0	0	0	0	0	0	0	0	0	0	0	0	0	0	R1	
		0	1	0	0	0	0	0	0	0	0	0	0	0	0	0	0	0	0	0	0	0	0	0	R2	
		:	:	:	:	:	:	:	:	:	:	:	:	:	:	:	:	:	:	:	:	:	:	:	R3~ R252	
	LIGHT	:	:	:	:	:	:	:	:	:	:	:	:	:	:	:	:	:	:	:	:	:	:	:		
		1	0	1	1	1	1	1	1	0	0	0	0	0	0	0	0	0	0	0	0	0	0	0	R252	
	0	1	1	1	1	1	1	1	1	0	0	0	0	0	0	0	0	0	0	0	0	0	0	0	R252	
RED	1	1	1	1	1	1	1	1	0	0	0	0	0	0	0	0	0	0	0	0	0	0	0	R252		
GRAY SCALE OF GREE N	BLACK	0	0	0	0	0	0	0	0	0	0	0	0	0	0	0	0	0	0	0	0	0	0	0	G0	
	DARK	0	0	0	0	0	0	0	0	1	0	0	0	0	0	0	0	0	0	0	0	0	0	0	G1	
		0	0	0	0	0	0	0	0	0	1	0	0	0	0	0	0	0	0	0	0	0	0	0	G2	
		:	:	:	:	:	:	:	:	:	:	:	:	:	:	:	:	:	:	:	:	:	:	:	G3~ G252	
	LIGHT	:	:	:	:	:	:	:	:	:	:	:	:	:	:	:	:	:	:	:	:	:	:	:		
		0	0	0	0	0	0	0	0	1	0	1	1	1	1	1	1	0	0	0	0	0	0	0	G252	
	0	0	0	0	0	0	0	0	0	0	1	1	1	1	1	1	1	0	0	0	0	0	0	0	G252	
GREEN	0	0	0	0	0	0	0	0	1	1	1	1	1	1	1	1	0	0	0	0	0	0	0	G252		
GRAY SCALE OF BLUE	BLACK	0	0	0	0	0	0	0	0	0	0	0	0	0	0	0	0	0	0	0	0	0	0	0	B0	
	DARK	0	0	0	0	0	0	0	0	0	0	0	0	0	0	0	0	1	0	0	0	0	0	0	B1	
		0	0	0	0	0	0	0	0	0	0	0	0	0	0	0	0	0	1	0	0	0	0	0	B2	
		:	:	:	:	:	:	:	:	:	:	:	:	:	:	:	:	:	:	:	:	:	:	:	B3~ B252	
	LIGHT	:	:	:	:	:	:	:	:	:	:	:	:	:	:	:	:	:	:	:	:	:	:	:		
		0	0	0	0	0	0	0	0	0	0	0	0	0	0	0	0	1	0	1	1	1	1	1	B252	
	0	0	0	0	0	0	0	0	0	0	0	0	0	0	0	0	0	0	1	1	1	1	1	1	B252	
BLUE	0	0	0	0	0	0	0	0	0	0	0	0	0	0	0	0	1	1	1	1	1	1	1	B252		

Note (1) Definition of Gray :

Rn : Red Gray, Gn : Green Gray, Bn : Blue Gray (n = Gray level)

Input Signal : 0 = Low level voltage, 1 = High level voltage

6. Interface Timing

6.1 Timing Parameters (DE only mode)

SIGNAL	ITEM	SYMBOL	MIN.	TYP.	MAX.	Unit	NOTE
Clock	Frequency	$1/T_C$	54.34	65.2	85.0	MHz	-
Hsync		F_H	61.7	74.1	93.2	KHz	-
Vsync		F_V	50	60	75	Hz	-
Vertical Display Term	Active Display Period	T_{VD}	1200	1200	1200	lines	-
	Vertical Total	T_V	1229	1235	-	lines	-
Horizontal Display Term	Active Display Period	T_{HD}	800	800	800	clocks	2pixel/clock
	Horizontal Total	T_H	850	880	-	clocks	2pixel/clock

Note (1) This product is DE only mode. The input of Hsync & Vsync signal does not have an effect on normal operation.

(2) Test Point : TTL control signal and CLK at LVDS Tx input terminal in system

(3) Internal Vcc = 3.3V

(4) VESA Standard CVT Reduced Blank Timing.

6.2 Timing diagrams of interface signal (DE only mode)

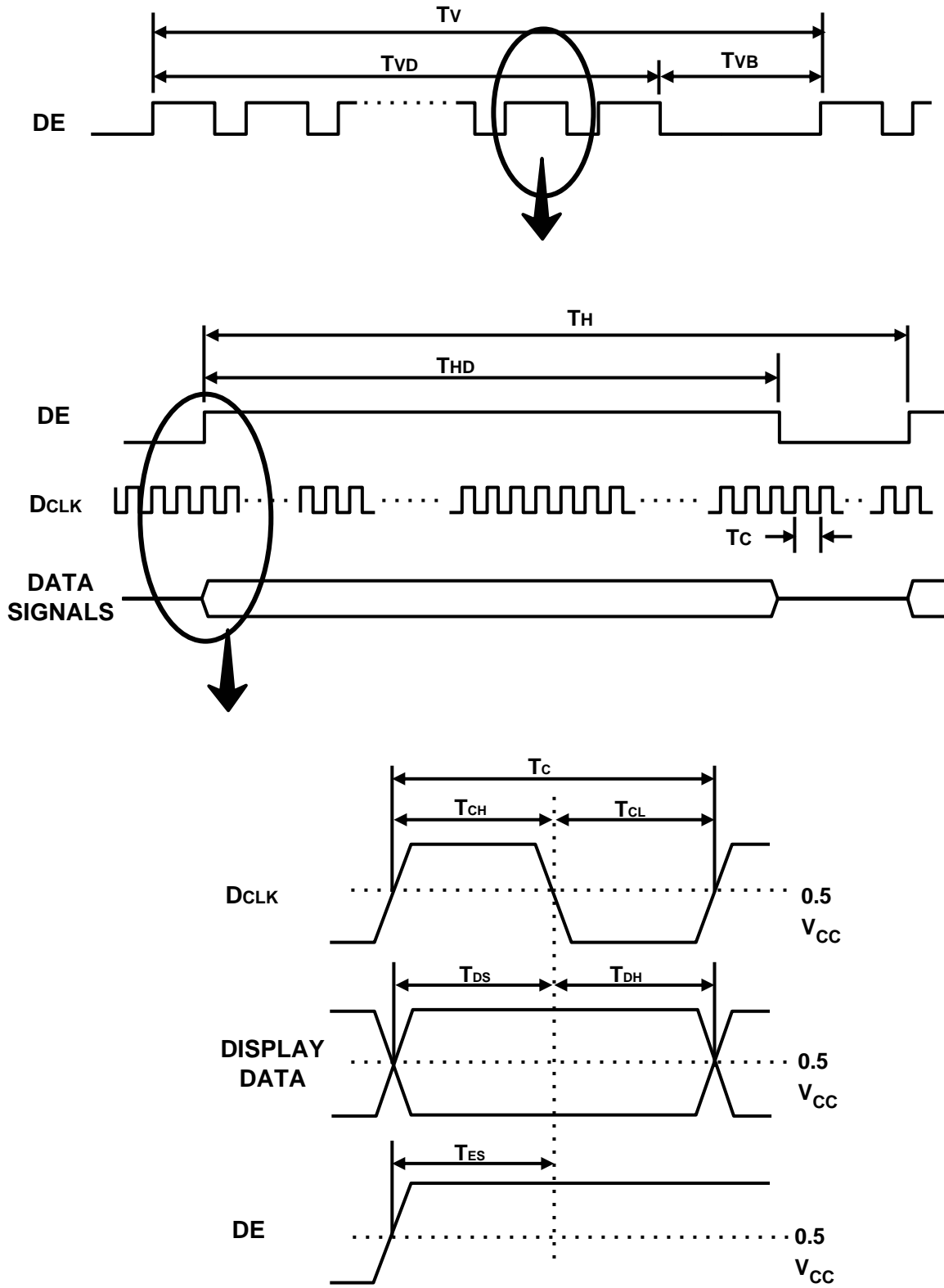

6.3 Power ON/OFF Sequence

To prevent a latch-up or DC operation of the LCD Module, the power on/off sequence should be as the diagram below.

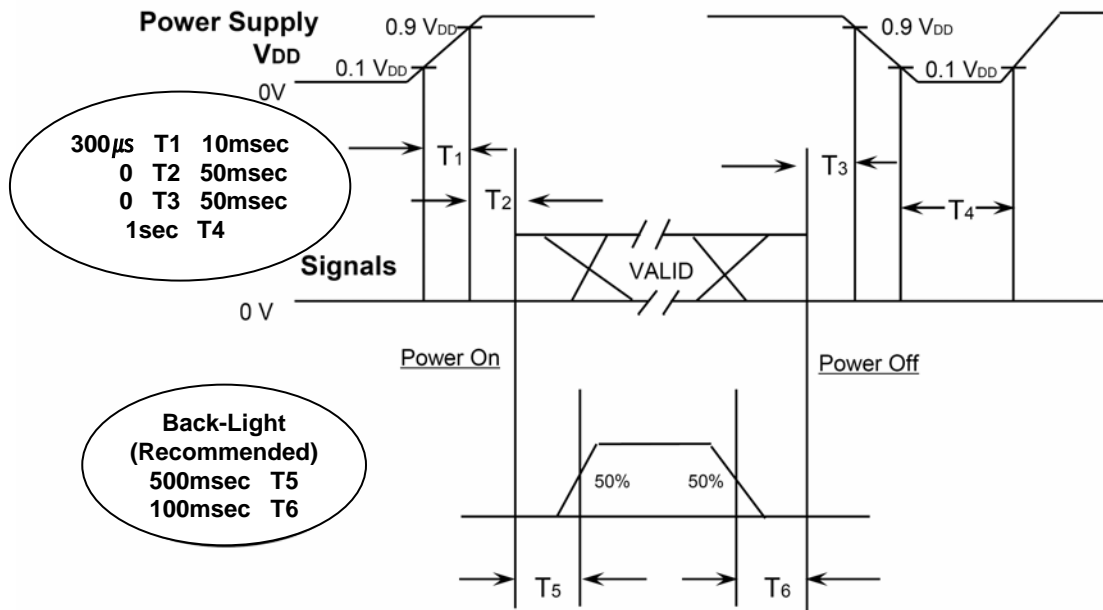

- T1 : V_{DD} rising time from 10% to 90%
- T2 : The time from V_{DD} to valid data at power ON.
- T3 : The time from valid data off to V_{DD} off at power Off.
- T4 : V_{DD} off time for Windows restart
- T5 : The time from valid data to B/L enable at power ON.
- T6 : The time from valid data off to B/L disable at power Off.

- The supply voltage of the external system for the Module input should be the same as the definition of V_{DD} .
- Apply the lamp voltage within the LCD operation range. When the back light turns on before the LCD operation or the LCD turns off before the back light turns off, the display may momentarily show abnormal screen.
- In case of V_{DD} = off level, please keep the level of input signals low or keep a high impedance.
- T4 should be measured after the Module has been fully discharged between power off and on period.
- Interface signal should not be kept at high impedance when the power is on.

6.5 VDD Power Dip Condition

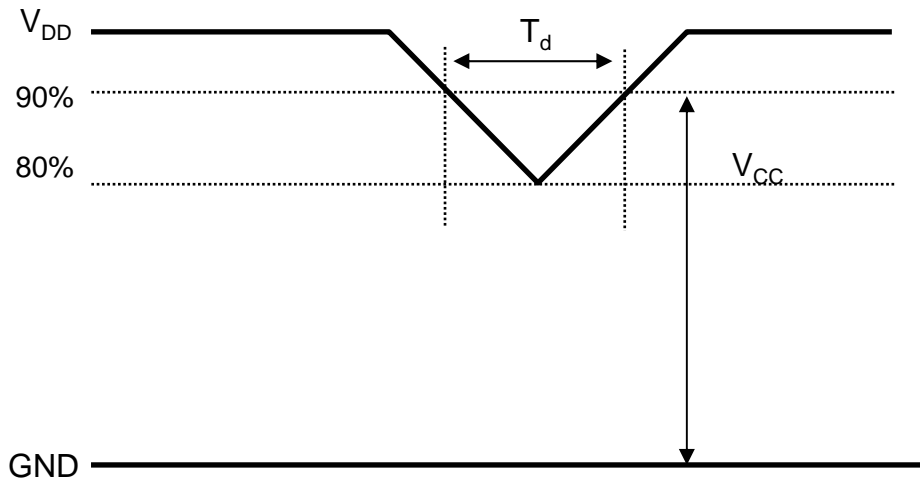

$\begin{aligned} &4.5V \quad V_{DD} \quad 5.5V \\ \text{If } V_{DD}(\text{typ.}) \times 80\% & \quad V_{CC} \quad V_{DD}(\text{typ}) \times 90\% \\ \text{Then, } 0 < T_d & \quad 20\text{msec} \end{aligned}$
--

- Note (1) The above conditions are for the glitch of the input voltage.
 (2) For stable operation of an LCD Module power, please follow them.
 i.e., if $\text{typ } V_{DD} \times 80\% \quad V_{CC} \quad \text{typ } V_{DD} \times 90\%$, then T_d should be less than 20ms.

7. Outline Dimension

[Refer to the next page]

NO.	PART NAME	CODE NO.	SPECIFICATION	QTY	UNIT	REMARKS

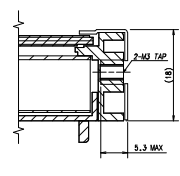
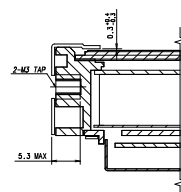
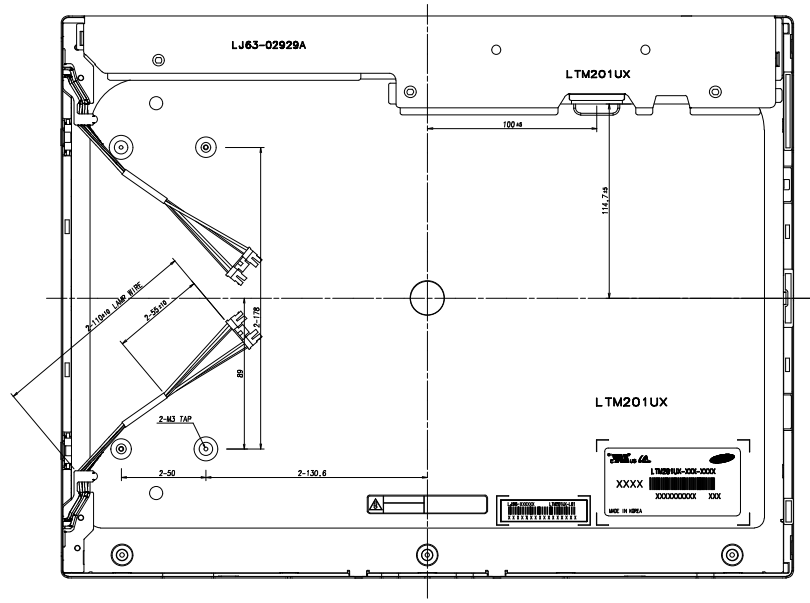
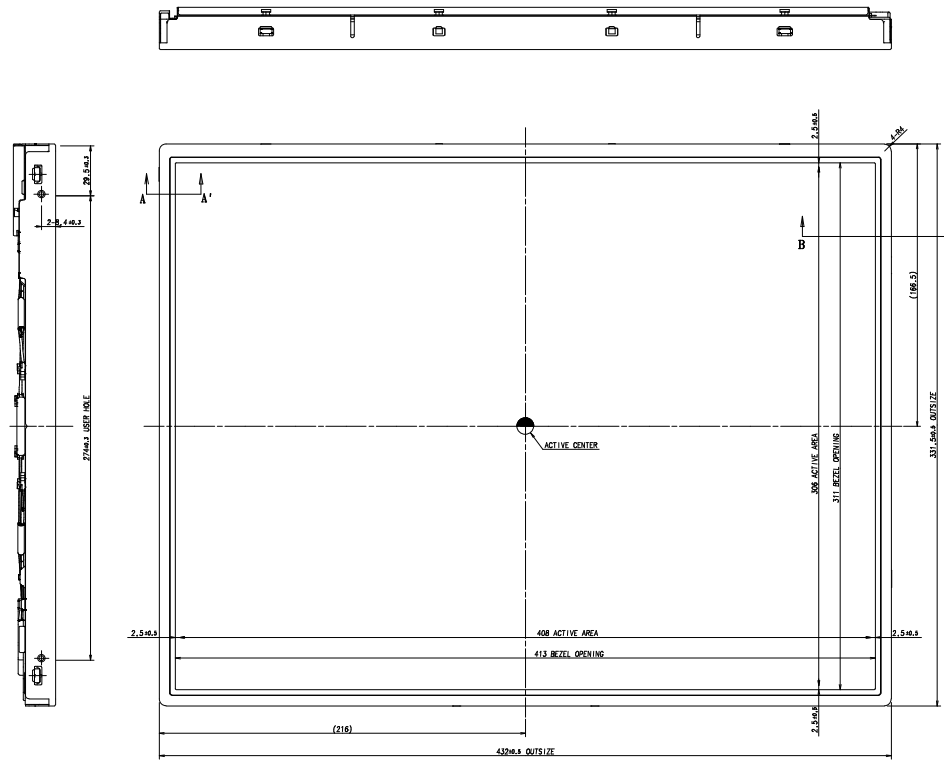

- * NOTES**
- BACKLIGHT : 4 COLD CATHODE FLUORESCENT LAMPS.
 - 1/F CONNECTOR SPECIFICATION.
F1-XB30SRL-HF-11 OR EQUIVLENT
 - LAMP CONNECTOR/WIRE SPECIFICATION.
YEON-HO 35001HS-04L OR EQUIVALENT
 - USER MOUNTING TORQUE SPEC : 3*4 Kgf-cm

GENERAL TOLERANCE		NO. IN QUANTITY	DESCRIPTION OF REVISION	DATE	BY	REASON
STEP	LEVEL 1 / LEVEL 2 / LEVEL	NO. 1 / NO. 2				
0 - 2 x 4	H0.05 / H0.1 / H0.2					
4 - 6 x 18	H0.08 / H0.15 / H0.2					
18 - 3 x 64	H0.12 / H0.25 / H0.3					
64 - 3 x 258	H0.25 / H0.4 / H0.8					

DATE	BY	DESCRIPTION	DATE	BY	DESCRIPTION

STEP	DATE	BY	DESCRIPTION

MODEL NAME	DATE	BY	DESCRIPTION
LTM201UX			

PART/ASSEMBLY NAME	DATE	BY	DESCRIPTION
OUTLINE DIM.			

CODE NO.	REV.	DATE	DESCRIPTION

ZD-WA-C-02

8. General Precautions

8.1 Handling

- (a) When the module is assembled, it should be attached to the system firmly using all mounting holes. Be careful not to twist and bend the module.
- (b) Because the inverter uses high voltages, it should be disconnected from power source before it is assembled or disassembled.
- (c) Refrain from strong mechanical shock and / or any force to the module. In addition to damage, it may cause improper operation or damage to the module and CCFT back light.
- (d) Note that polarizer films are very fragile and could be damaged easily. Do not press or scratch the surface harder than a HB pencil lead.
- (e) Wipe off water droplets or oil immediately. If you leave the droplets for a long time, staining or discoloration may occur.
- (f) If the surface of the polarizer is dirty, clean it using absorbent cotton or soft cloth.
- (g) Desirable cleaners are water, IPA (Isopropyl Alcohol) or Hexane. Do not use Ketone type materials (ex. Acetone), Ethyl alcohol, Toluene, Ethyl acid or Methyl chloride. It might cause permanent damage to the polarizer due to chemical reaction.
- (h) If the liquid crystal material leaks from the panel, it should be kept away from the eyes or mouth . In case of contact with hands, legs or clothes, it must be washed away with soap thoroughly.
- (i) Protect the Module from static, or the CMOS Gate Array IC would be damaged.
- (j) Use finger-stalls with soft gloves in order to keep display clean during the incoming inspection and assembly process.
- (k) Do not disassemble the Module.
- (l) Do not pull or fold the lamp wire.
- (m) Do not adjust the variable resistor located on the Module.
- (n) Protection film for polarizer on the Module should be slowly peeled off just before use so that the electrostatic charge can be minimized.
- (o) Pins of I/F connector should not be touched directly with bare hands.

8.2 Storage

- (a) Do not leave the Module in high temperature, and high humidity for a long time. It is highly recommended to store the Module with temperature from 0 to 35 and relative humidity of less than 70%.
- (b) Do not store the TFT-LCD Module in direct sunlight.
- (c) The Module should be stored in a dark place. It is prohibited to apply sunlight or fluorescent light in storing.

8.3 Operation

- (a) Do not connect or disconnect the Module in the "Power On" condition.
- (b) Power supply should always be turned on/off by the item 6.3 "Power on/off sequence"
- (c) Module has high frequency circuits. Sufficient suppression to the electromagnetic interference should be done by system manufacturers. Grounding and shielding methods may be important to minimize the interference.
- (d) The cable between the back light connector and its inverter power supply should be connected directly with a minimized length. A longer cable between the back light and the inverter may cause lower luminance of lamp(CCFT) and may require higher startup voltage(Vs).

8.4 Operation Condition Guide

- (a) The LCD product should be operated under normal conditions.
Normal condition is defined as below;
 - Temperature : 20 ± 15
 - Humidity : $65 \pm 20\%$
 - Display pattern : continually changing pattern (Not stationary)
- (b) If the product will be used in extreme conditions such as high temperature, humidity, display patterns or operation time etc., It is strongly recommended to contact SEC for Application engineering advice. Otherwise, its reliability and function may not be guaranteed. Extreme conditions are commonly found at Airports, Transit Stations, Banks, Stock market, and Controlling systems.

8.5 Others

- (a) Ultra-violet ray filter is necessary for outdoor operation.
- (b) Avoid condensation of water. It may result in improper operation or disconnection of electrode.
- (c) Do not exceed the absolute maximum rating value. (supply voltage variation, input voltage variation, variation in part contents and environmental temperature, and so on)
Otherwise the Module may be damaged.
- (d) If the Module keeps displaying the same pattern for a long period of time, the image may be "sticked" to the screen.
To avoid image sticking, it is recommended to use a screen saver.
- (e) This Module has its circuitry PCB's on the rear side and should be handled carefully in order not to be stressed.
- (f) Please contact SEC in advance when you display the same pattern for a long time.