

# **LQ281L1LW11**

## **TFT-LCD Module**

Spec. Issue Date: July 1, 2005

No: LD15212B

PREPARED BY :    DATE	 Mobile Liquid Crystal Display Group SHARP CORPORATION  <b>SPECIFICATION</b>	SPEC No. LD15212B
APPROVED BY :    DATE		FILE No.
		ISSUE : Jul.01. 2005
		PAGE : 23 pages
		APPLICABLE GROUP Mobile Liquid Crystal Display Group

DEVICE SPECIFICATION FOR  
**TFT-LCD Module**  
 MODEL No.  
**LQ281L1LW11**

CUSTOMER'S APPROVAL

DATE \_\_\_\_\_

BY \_\_\_\_\_

PRESENTED

BY *T. Naka*

T. Naka  
 Division deputy general manager of  
 Mobile LCD Design Center II  
 Engineering Department V  
 Mobile LCD Design Center II  
 Mobile Liquid Crystal Display Group  
 SHARP CORPORATION



## 1. Application 2

This specification applies to the color 28.05inch 2048x2048 TFT-LCD module LQ281L1LW11.

These specification sheets are the proprietary product of SHARP CORPORATION("SHARP") and include materials protected under the copyright of SHARP. Do not reproduce or cause any third party to reproduce them in any form or by any means, electronic or mechanical, for any purpose, in whole or in part, without the express written permission of SHARP.

In case of using the device for applications such as control and safety equipment for transportation(aircraft, trains, automobiles, etc. ), rescue and security equipment and various safety related equipment which require higher reliability and safety, take into consideration that appropriate measures such as fail-safe functions and redundant system design should be taken.

Do not use the device for equipment that requires an extremely high level of reliability, such as medical equipment for life support.

SHARP assumes no responsibility for any damage resulting from the use of the device which does not comply with the instructions and the precautions specified in these specification sheets.

Contact and consult with a SHARP sales representative for any questions about this device.

## 2. Overview

This module is a color active matrix LCD module incorporating amorphous silicon TFT (Thin Film Transistor). It is composed of a color TFT-LCD panel, driver ICs, control circuit, power supply circuit a backlight unit ,and backlight inverters. Graphics and texts can be displayed on a 2048 × 3 × 2048 dots panel with about 16.77 million colors (8 bit) by supplying 192 bit data signals(8bit × 2pixel × RGB × 4), eight display enable signals, and eight dot clock signals by LVDS, and +12V DC supply voltages for TFT-LCD panel driving and back light. The backlight inverters are built into this module.

## 3. Mechanical Specifications

Parameter	Specifications	Unit
Display size	71.2 (Diagonal)	cm
	28.05 (Diagonal)	Inch
Active area	503.808 (H) × 503.808 (V)	mm
Pixel format	2048 (H) × 2048 (V)	Pixel
	(1 pixel = R + G + B dots)	
Pixel pitch	0.246 (H) × 0.246 (V)	mm
Pixel configuration	R,G,B vertical stripe	
Display mode	Normally Black	
Unit outline dimensions *1	594 (W) × 594 (H) × 60(*1)/83(*2) (D)	mm
Mass	15 Typ	kg
Surface treatment	Anti-glare and hard-coating 2H	

\*1.Note: The thickness of module (D) doesn't contain the projection.

\*2.Note: The thickness of module (D) contains the projection.

Outline dimensions are shown in Fig.4 and Fig.5.

## 4. Input Terminals and their function

### 4-1. Interface signals

CN1(A area), CN2(B area), CN3(C area), CN4(D area) in Fig.1

Using connector : 10240-1210VE (3M)

Mating connector : 10140- (3M)

Using LVDS Receiver : DS90CF386(National Semiconductor Corp.) or THC63LVDF84B(Thine)

Pin Diagrams(CN1 - CN4)

Pin No.	Symbol	Function	Remark
1	NC	OPEN	-
2	RxBIN3 +	Positive ( + ) LVDS differential data input CH3(B port)	LVDS
3	GND	GND	GND
4	RxBIN3 -	Negative ( - ) LVDS differential data input CH3(B port)	LVDS
5	RxBCLKIN +	Positive ( + ) LVDS differential clock input (B port)	LVDS
6	GND	GND	GND
7	RxBCLKIN -	Negative ( - ) LVDS differential clock input (B port)	LVDS
8	NC	OPEN	-
9	NC	OPEN	-
10	RxBIN2 +	Positive ( + ) LVDS differential data input CH2(B port)	LVDS
11	GND	GND	GND
12	RxBIN2 -	Negative ( - ) LVDS differential data input CH2(B port)	LVDS
13	RxBIN1 +	Positive ( + ) LVDS differential data input CH1(B port)	LVDS
14	GND	GND	GND
15	RxBIN1 -	Negative ( - ) LVDS differential data input CH1(B port)	LVDS
16	NC	OPEN	-
17	NC	OPEN	-
18	RxBIN0 +	Positive ( + ) LVDS differential data input CH0(B port)	LVDS
19	GND	GND	GND
20	RxBIN0 -	Negative ( - ) LVDS differential data input CH0(B port)	LVDS
21	RxAIN3 +	Positive ( + ) LVDS differential data input CH3(A port)	LVDS
22	GND	GND	GND
23	RxAIN3 -	Negative ( - ) LVDS differential data input CH3(A port)	LVDS
24	NC	OPEN	-
25	NC	OPEN	-
26	RxACLKIN +	Positive ( + ) LVDS differential clock input (A port)	LVDS
27	GND	GND	GND
28	RxACLKIN -	Negative ( - ) LVDS differential clock input (A port)	LVDS
29	RxAIN2 +	Positive ( + ) LVDS differential data input CH2(A port)	LVDS
30	GND	GND	GND
31	RxAIN2 -	Negative ( - ) LVDS differential data input CH2(A port)	LVDS
32	NC	OPEN	-
33	NC	OPEN	-
34	RxAIN1 +	Positive ( + ) LVDS differential data input CH1(A port)	LVDS
35	GND	GND	GND
36	RxAIN1 -	Negative ( - ) LVDS differential data input CH1(A port)	LVDS
37	RxAIN0 +	Positive ( + ) LVDS differential data input CH0(A port)	LVDS
38	GND	GND	GND
39	RxAIN0 -	Negative ( - ) LVDS differential data input CH0(A port)	LVDS
40	NC	OPEN	-

Pin arrangement is shown in Fig.5

Data Mapping (National Semiconductor Corp.:DS90C385) or THC63LVDM83R(Thine)

A port Data

B port Data

Input Signal	Transmitter		Connector	Input Signal	Transmitter		Connector
	Pin	Data			Pin	Data	
RA2	51	TxIN0	RxAIN0 ±	RB2	51	TxIN0	RxBIN0 ±
RA3	52	TxIN1		RB3	52	TxIN1	
RA4	54	TxIN2		RB4	54	TxIN2	
RA5	55	TxIN3		RB5	55	TxIN3	
RA6	56	TxIN4		RB6	56	TxIN4	
RA7	3	TxIN6		RB7	3	TxIN6	
GA2	4	TxIN7		GB2	4	TxIN7	
GA3	6	TxIN8	RxAIN1 ±	GB3	6	TxIN8	RxBIN1 ±
GA4	7	TxIN9		GB4	7	TxIN9	
GA5	11	TxIN12		GB5	11	TxIN12	
GA6	12	TxIN13		GB6	12	TxIN13	
GA7	14	TxIN14		GB7	14	TxIN14	
BA2	15	TxIN15		BB2	15	TxIN15	
BA3	19	TxIN18		BB3	19	TxIN18	
BA4	20	TxIN19	RxAIN2 ±	BB4	20	TxIN19	RxBIN2 ±
BA5	22	TxIN20		BB5	22	TxIN20	
BA6	23	TxIN21		BB6	23	TxIN21	
BA7	24	TxIN22		BB7	24	TxIN22	
RSVD(NA)	27	TxIN24		RSVD(NA)	27	TxIN24	
RSVD(NA)	28	TxIN25		RSVD(NA)	28	TxIN25	
DE	30	TxIN26		DE	30	TxIN26	
RA0	50	TxIN27	RxAIN3 ±	RB0	50	TxIN27	RxBIN3 ±
RA1	2	TxIN5		RB1	2	TxIN5	
GA0	8	TxIN10		GB0	8	TxIN10	
GA1	10	TxIN11		GB1	10	TxIN11	
BA0	16	TxIN16		BB0	16	TxIN16	
BA1	18	TxIN17		BB1	18	TxIN17	
RSVD(NA)	25	TxIN23		RSVD(NA)	25	TxIN23	
CLK	31	TxCLKIN	RxACLKIN ±	CLK	31	TxCLKIN	RxBCLKIN ±

RSVD: Non connect

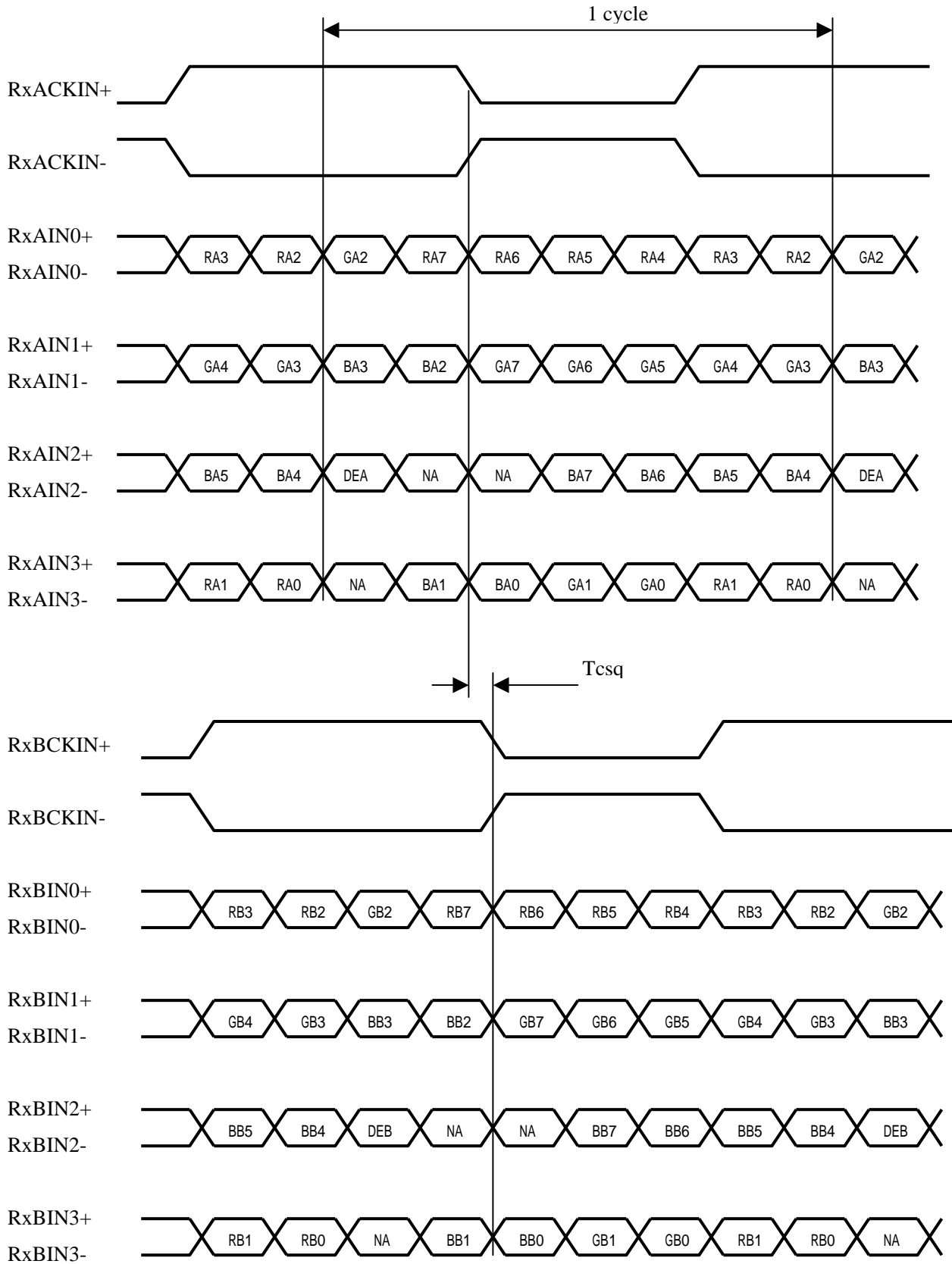

DE: Display Enable

NA: Not Available



4-2 Power supply for the TFT LCD.

CN5

Using connector : RP13A-12RC-20PB(HIROSE ELECTRIC Co.,Ltd)

Mating connector : RP13A-12PG-20SC (HIROSE ELECTRIC Co.,Ltd)

CN5

Pin No.	Symbol	Function	Remark
1	B/L 12V	Power supply for the Backlight (DC12V)	
2	B/L 12V	Power supply for the Backlight (DC12V)	
3	B/L 12V	Power supply for the Backlight (DC12V)	
4	B/L 12V	Power supply for the Backlight (DC12V)	
5	B/L 12V	Power supply for the Backlight (DC12V)	
6	B/L 12V	Power supply for the Backlight (DC12V)	
7	B/L 12V	Power supply for the Backlight (DC12V)	
8	B/L 12V	Power supply for the Backlight (DC12V)	
9	B/L GND	GND for the Backlight	
10	B/L GND	GND for the Backlight	
11	B/L GND	GND for the Backlight	
12	B/L GND	GND for the Backlight	
13	B/L GND	GND for the Backlight	
14	B/L GND	GND for the Backlight	
15	B/L GND	GND for the Backlight	
16	B/L GND	GND for the Backlight	
17	GND	GND	
18	GND	GND	
19	VCC12V	Power supply for the TFT LCD (DC12V)	
20	VCC12V	Power supply for the TFT LCD (DC12V)	

Pin arrangement is shown in Fig.5

4-3. Adjustment of Luminance

CN6

Using connector : S5B-PH-SM3-TB(J.S.T. Co. Ltd.)

Mating connector : PHR-5(J.S.T. Co. Ltd.)

Pin No.	Symbol	Function	Remarks
1	5.0V	Output terminal for output voltage.	
2	Vhign	Output terminal for output voltage to supply adjusted voltage, Vbr.	
3	Vbr	Dimmer voltage input.	
4	Vlow	Output terminal for output voltage to supply adjusted voltage, Vbr.	
5	GND	GND	

Pin arrangement is shown in Fig.5

## 4-4. Detection of an abnormality

### CN7

Using connector : HIF3BA-10PA-2.54DS(HIROSE ELECTRIC Co.,Ltd.)

Mating connector : HIF3BA-10D-2.54R (HIROSE ELECTRIC Co.,Ltd.)

Pin No.	Symbol	Function	Remarks
1	BITE-cable	Alarm output of connection of cable for CN7.	
2	INV-U	Alarm output of backlight unit at topside.	
3	INV-M	Alarm output of backlight unit at middle side.	
4	INV-L	Alarm output of backlight unit at bottom side	
5	B/L-Fuse	Alarm output of backlight fuse.	
6	VDD-fuse	Alarm output of VDD fuse.	
7	Sig-Detect	Alarm output of detection of input signal.	
8	Reserve	For future use.	
9	GND1	GND	
10	GND2	GND	

Pin arrangement is shown in Fig.5

\*An example of output signal when an abnormality is detected. 【Note1】

Mode of abnormality	Pin number							Remarks
	1	2	3	4	5	6	7	
VDD fuse is blown.	H	L	L	L	H	L	L	
The inverter fuse is blown.	L	L	L	L	L	L	L	
The lamp in the lamp tray at the top side is burned out or the inverter at the top side has an abnormality.	H	L	H	H	H	H	H	
The lamp in the lamp tray at the middle side is burned out or the inverter at the middle side has an abnormality.	H	H	L	H	H	H	H	
The lamp in the lamp tray at the bottom side is burned out or the inverter at the bottom side has an abnormality.	H	H	H	L	H	H	H	
No incoming signal.	H	L	L	L	H	H	L	【Note2】

【Note1】 When an abnormality is detected, an output signal is Low. When system has no problem, an output signal is High.

【Note2】 If any of input signals from CN1 to CN4 has abnormality, then low level is returned.

## Interface Block

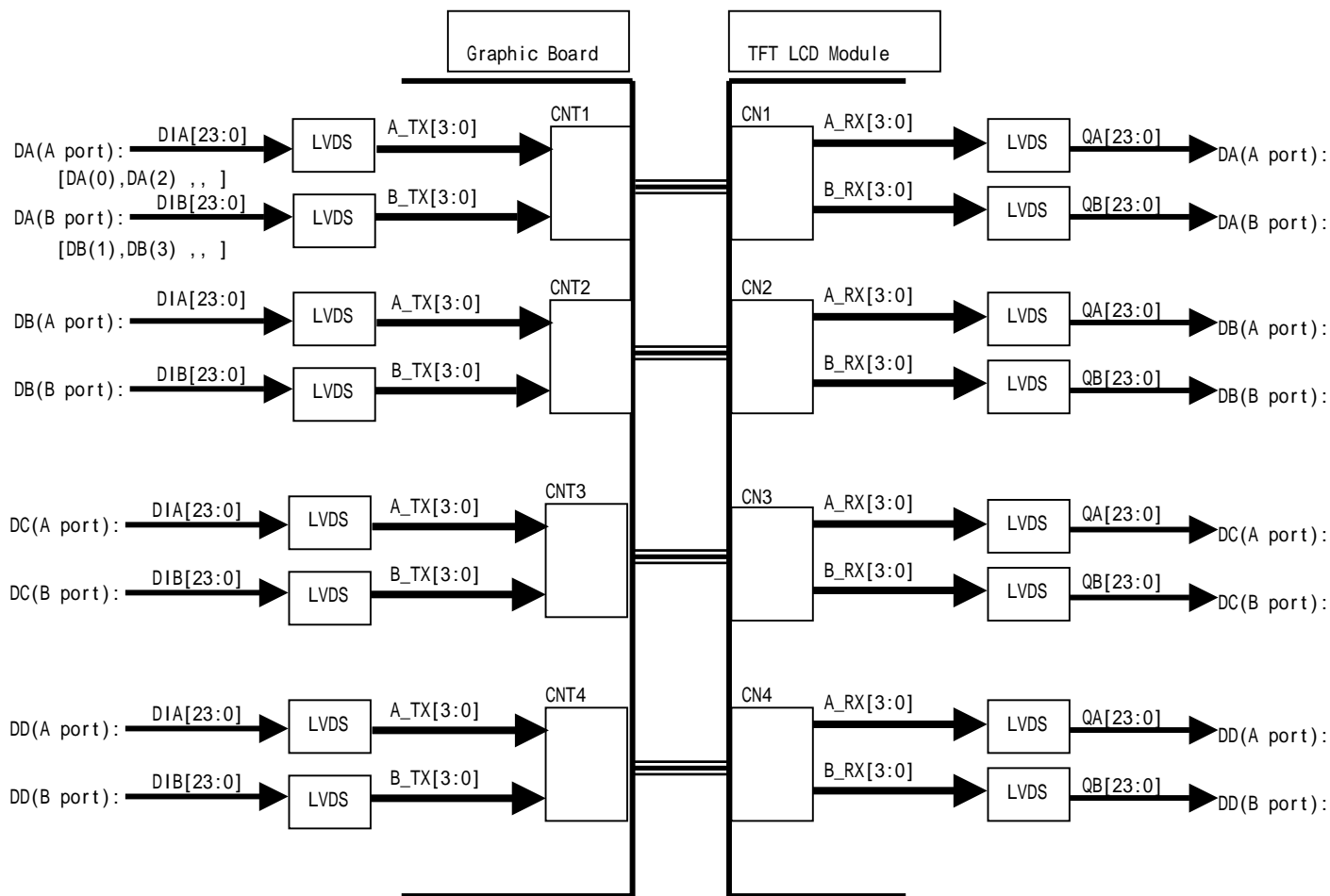

## Relation between screen and pixel data

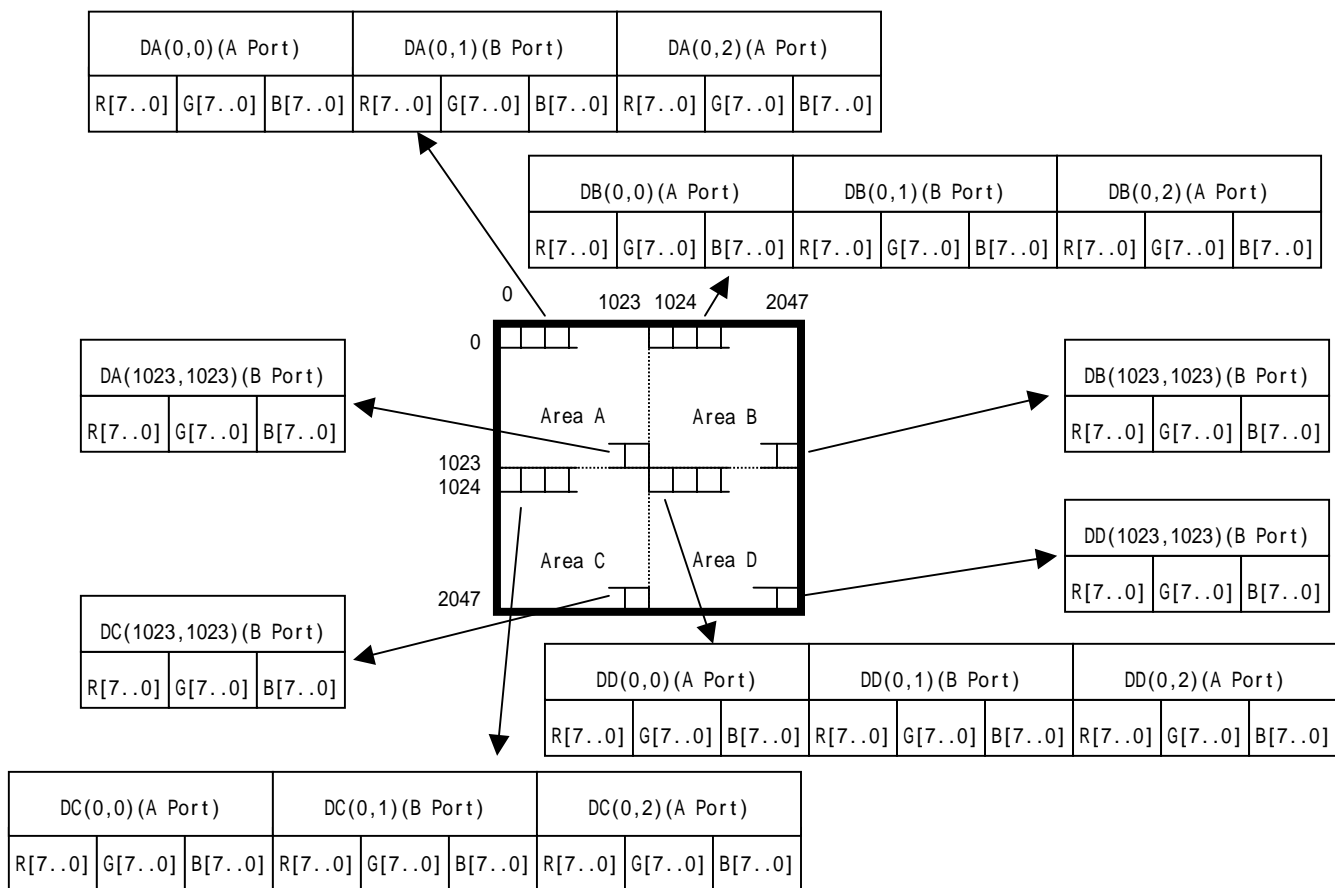

Fig.1 Relation between Data and Display Area

## 5. Absolute Maximum Ratings

### 5-1. Module

Parameter	Symbol	Condition	Ratings	Unit	Remark
Storage temperature	Tstg	-	- 25 ~ + 60		【Note1】
Operating temperature (Ambient)	Topa	-	0 ~ + 40		

【Note1】 Humidity : 95%RH Max. ( Ta 40 )

Be careful for electrostatic build up, but no condensation.

In case of using the module mounted in package, inner temperature should be +10 or less from ambient temperature.

### 5-2. TFT-LCD panel and backlight driving

Parameter	Symbol	Condition	Ratings	Unit	Remark
12V power supply voltage	Vcc_12V B/L_12V	Ta=25	0 ~ +14.0V	V	

## 6. Electrical Characteristics

### 6-1. TFT-LCD panel driving

Ta=25

Parameter		Symbol	Min.	Typ.	Max.	Unit	Remark
+12V supply voltage	Supply voltage	VCC12V	11.4	12.0	12.6	V	【Note1】
	Current dissipation	I <sub>cc</sub>	-	1.3	2.0	A	【Note2】
	Rush current	I <sub>r</sub>			7		A
T <sub>r</sub>				3		ms	
Permissible input ripple voltage		V <sub>RF</sub>	-	-	100	mV <sub>P-P</sub>	
Differential input voltage		V <sub>ID</sub>	75		1000	mV	
Input Leakage Current		I <sub>O</sub>	-10		10	μA	

### 6-2. Backlight driving

Ta=25

Parameter		Symbol	Min.	Typ.	Max.	Unit	Remark
+12V supply voltage	Supply voltage	B/L 12V	11.4	12.0	12.6	V	【Note1】
	Current dissipation	I <sub>cc</sub>	-	-	13.5	A	
Permissible input ripple voltage		V <sub>RF</sub>	-	-	100	mV <sub>P-P</sub>	【Note4】

### 6-3. Adjustment of Luminance

Ta=25

Parameter	Symbol	Min.	Typ.	Max.	Unit	Remark
The high level voltage that supply dimmer voltage, V <sub>br</sub> .	V <sub>high</sub>	3.1	3.23	3.4	V	
The low level voltage that supply dimmer voltage, V <sub>br</sub> .	V <sub>low</sub>	0.8	0.9	1.0	V	
Dimmer voltage input	V <sub>br</sub>	V <sub>low</sub>		V <sub>high</sub>	V	【Note5】

#### 【Note1】

1) On-off sequences of V<sub>cc</sub> and data

- 0 < t<sub>1</sub> 60ms
- 0 < t<sub>2</sub> 10ms
- 0 < t<sub>3</sub> 1s
- t<sub>4</sub> 100ms

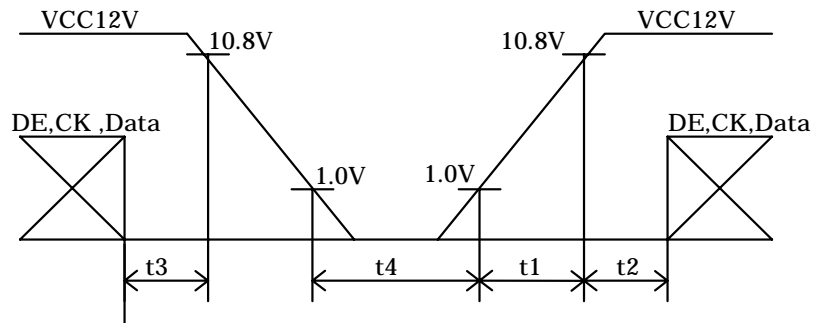

2) Dip conditions for supply voltage  
 (  $V_{min}, V_{th}$  ) = ( 11.4V, 9.6V )

i)  $V_{th} < V_{CC12V} < V_{min}$   
 $t_d = 20ms$

ii)  $V_{CC12V} < V_{th}$

This case is described below \*1.

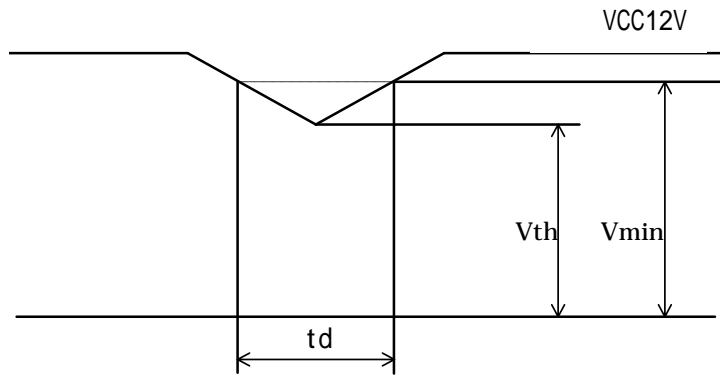

\*1 The LCD module shuts down when  $V_{CC12V} < V_{th}$ . It should also follow the 1) on-off sequence of VCC12V and data.

**【Note2】**

1) Typical current situation : 16-gray-bar pattern

$V_{cc} = +12.0V$

Gray scale : GS(16N)

$N = 0 \sim 15$

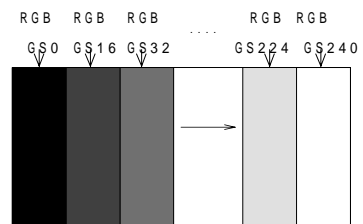

The explanation of each gray scale ,GS(16n), is described below section 8.

2) Maximum current situation : The left pattern of a figure (pattern1) by using the right scale of a figure (scale1).

Note: S = 255

VS means the voltage of V255 scale.

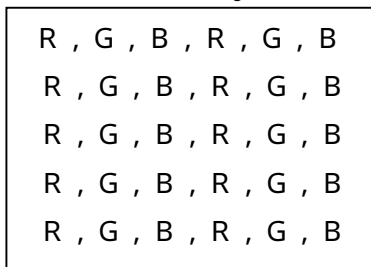

Pattern1

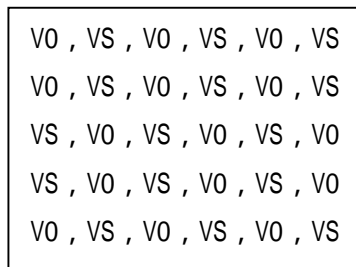

Scale1

**【Note3】** When power is supplied or when LCD starts to work by incoming input signal, the rush current flows.

Be careful that power circuit is never less than 11V when the rush current flows.

**【Note4】** It doesn't contain input ripple voltage of inverter switching by duty control.

The ripple voltage of inverter by duty control: 300mVp-p

**【Note5】** Relation between Adjusted voltage Vbr and Luminance

Adjusted Voltage(Vbr)	Min.(Vlow)	↔	Max(Vhigh)
Luminance	Min. (Dimmer:Min)	↔	Max. (Dimmer:Max)

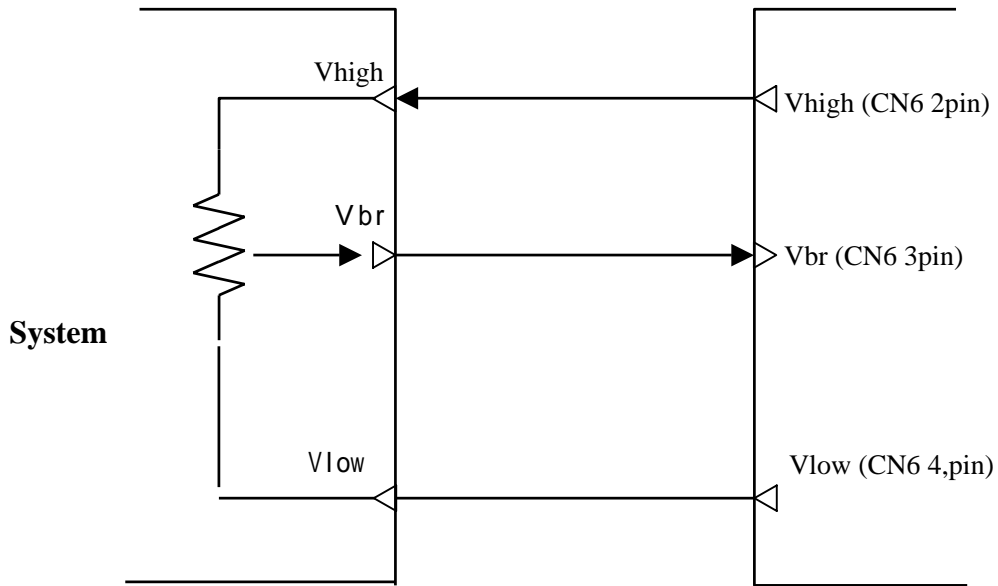

## 7. Timing characteristics of input signals

Parameter		Symbol	Min.	Typ.	Max.	Unit	Remark
Clock(CLK)	Frequency	1/Tc	28	35	47.3	MHz	
	Skew	Tcsq	-4	0	4	ns	【Note1】
Data Enable signal (DE)	Horizontal period	TH	528	550	860	Clock	
			12.9	15.7	19.4	μs	
	Horizontal period (Display Period)	THd	512	512	512	clock	
	Vertical period	TV	1026	1060	1535	line	【Note2】
			50	60	70	Hz	【Note3】
Vertical period (Display Period)	TVd	1024	1024	1024	Line		

【Note1】 The difference of clock phase between LVDS port A and port B.

【Note2】 In case of using the long vertical period, the deterioration of display quality, flicker etc. may occur.

【Note3】 There should be integral horizontal period per one vertical period.

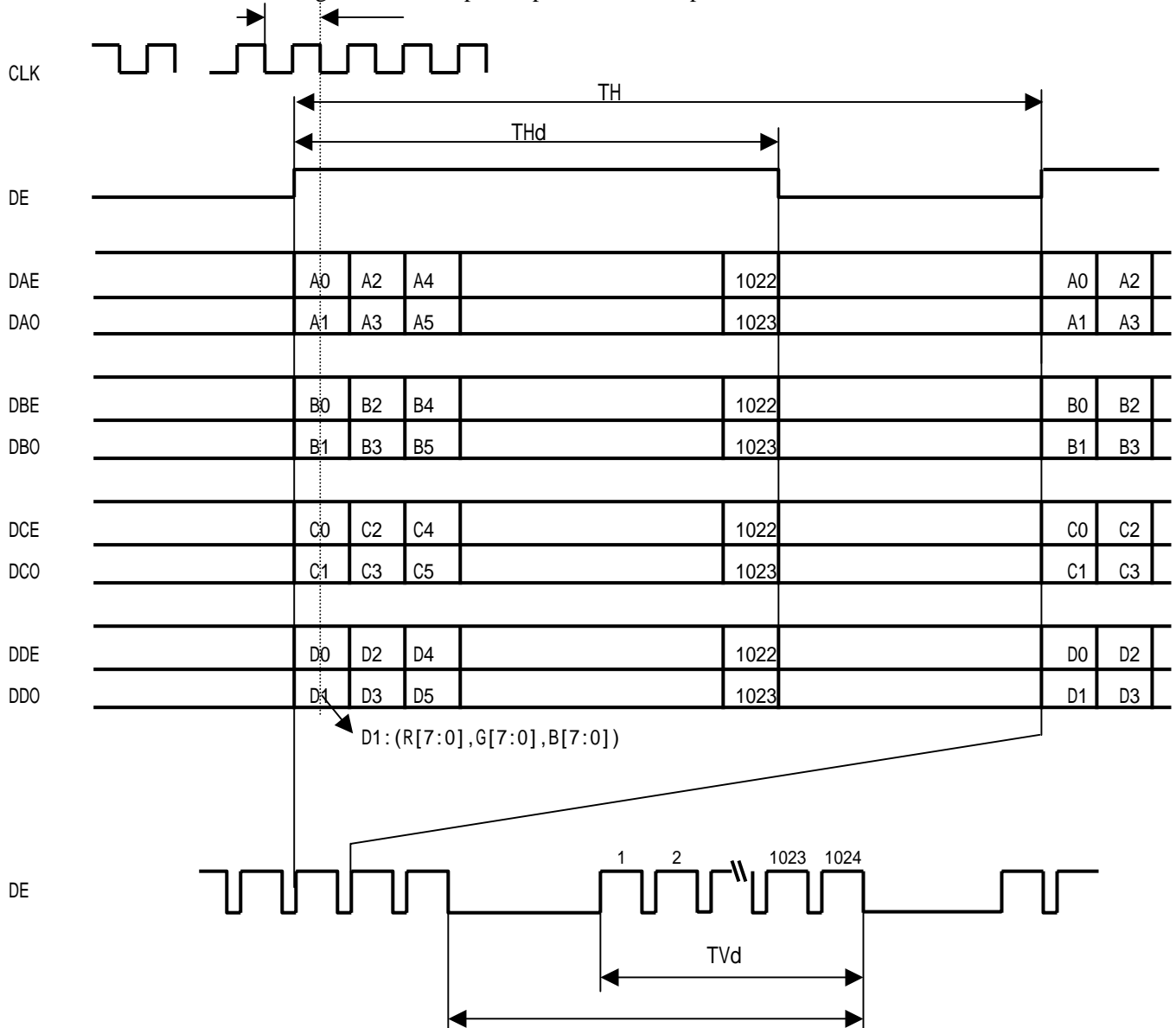



## 8. Input Signals, Basic Display Colors and Gray Scale of Each Color

	Colors & Gray Scale	Data Signal																											
		Gray Scale	RA0 RA1 RA2 RA3 RA4 RA5 RA6 RA7	GA0 GA1 GA2 GA3 GA4 GA5 GA6 GA7	BA0 BA1 BA2 BA3 BA4 BA5 BA6 BA7																								
			RB0 RB1 RB2 RB3 RB4 RB5 RB6 RB7	GB0 GB1 GB2 GB3 GB4 GB5 GB6 GB7	BB0 BB1 BB2 BB3 BB4 BB5 BB6 BB7																								
			RC0 RC1 RC2 RC3 RC4 RC5 RC6 RC7	GC0 GC1 GC2 GC3 GC4 GC5 GC6 GC7	BC0 BC1 BC2 BC3 BC4 BC5 BC6 BC7																								
		RD0 RD1 RD2 RD3 RD4 RD5 RD6 RD7	GD0 GD1 GD2 GD3 GD4 GD5 GD6 GD7	BD0 BD1 BD2 BD3 BD4 BD5 BD6 BD7																									
Basic Color	Black	-	0 0 0 0 0 0 0 0	0 0 0 0 0 0 0 0	0 0 0 0 0 0 0 0																								
	Blue	-	0 0 0 0 0 0 0 0	0 0 0 0 0 0 0 0	1 1 1 1 1 1 1 1																								
	Green	-	0 0 0 0 0 0 0 0	1 1 1 1 1 1 1 1	0 0 0 0 0 0 0 0																								
	Cyan	-	0 0 0 0 0 0 0 0	1 1 1 1 1 1 1 1	1 1 1 1 1 1 1 1																								
	Red	-	1 1 1 1 1 1 1 1	0 0 0 0 0 0 0 0	0 0 0 0 0 0 0 0																								
	Magenta	-	1 1 1 1 1 1 1 1	0 0 0 0 0 0 0 0	1 1 1 1 1 1 1 1																								
	Yellow	-	1 1 1 1 1 1 1 1	1 1 1 1 1 1 1 1	0 0 0 0 0 0 0 0																								
	White	-	1 1 1 1 1 1 1 1	1 1 1 1 1 1 1 1	1 1 1 1 1 1 1 1																								
Gray Scale of Red	Black	GS0	0 0 0 0 0 0 0 0	0 0 0 0 0 0 0 0	0 0 0 0 0 0 0 0																								
	↑	GS1	1 0 0 0 0 0 0 0	0 0 0 0 0 0 0 0	0 0 0 0 0 0 0 0																								
	Darker	GS2	0 1 0 0 0 0 0 0	0 0 0 0 0 0 0 0	0 0 0 0 0 0 0 0																								
	↑	↓																											
	↓	↓																											
	Brighter	GS253	1 0 1 1 1 1 1 1	0 0 0 0 0 0 0 0	0 0 0 0 0 0 0 0																								
	↓	GS254	0 1 1 1 1 1 1 1	0 0 0 0 0 0 0 0	0 0 0 0 0 0 0 0																								
	Red	GS255	1 1 1 1 1 1 1 1	0 0 0 0 0 0 0 0	0 0 0 0 0 0 0 0																								
Gray Scale of Green	Black	GS0	0 0 0 0 0 0 0 0	0 0 0 0 0 0 0 0	0 0 0 0 0 0 0 0																								
	↑	GS1	0 0 0 0 0 0 0 0	1 0 0 0 0 0 0 0	0 0 0 0 0 0 0 0																								
	Darker	GS2	0 0 0 0 0 0 0 0	0 1 0 0 0 0 0 0	0 0 0 0 0 0 0 0																								
	↑	↓																											
	↓	↓																											
	Brighter	GS253	0 0 0 0 0 0 0 0	1 0 1 1 1 1 1 1	0 0 0 0 0 0 0 0																								
	↓	GS254	0 0 0 0 0 0 0 0	0 1 1 1 1 1 1 1	0 0 0 0 0 0 0 0																								
	Green	GS255	0 0 0 0 0 0 0 0	1 1 1 1 1 1 1 1	0 0 0 0 0 0 0 0																								
Gray Scale of Blue	Black	GS0	0 0 0 0 0 0 0 0	0 0 0 0 0 0 0 0	0 0 0 0 0 0 0 0																								
	↑	GS1	0 0 0 0 0 0 0 0	0 0 0 0 0 0 0 0	1 0 0 0 0 0 0 0																								
	Darker	GS2	0 0 0 0 0 0 0 0	0 0 0 0 0 0 0 0	0 1 0 0 0 0 0 0																								
	↑	↓																											
	↓	↓																											
	Brighter	GS253	0 0 0 0 0 0 0 0	0 0 0 0 0 0 0 0	1 0 1 1 1 1 1 1																								
	↓	GS254	0 0 0 0 0 0 0 0	0 0 0 0 0 0 0 0	0 1 1 1 1 1 1 1																								
	Blue	GS255	0 0 0 0 0 0 0 0	0 0 0 0 0 0 0 0	1 1 1 1 1 1 1 1																								

0 : Low level voltage, 1 : High level voltage.

Each basic color can be displayed in 256 gray scales from 8 bit data signals. According to the combination of total 192 bit data signals, the 16.77-million-color display can be achieved on the screen.

## 9. Optical Characteristics 1

Ta=25 , VCC12V=+12V

Parameter		Symb ol	Condition	Min.	Typ.	Max.	Unit	Remark
Viewing Angle range	Vertical	11	CR 10	70	85	-	Deg.	【Note1,4】
		12		70	85	-	Deg.	
	Horizontal	21, 22		70	85	-	Deg.	
Contrast ratio		CR	=0 °	400	450	-	-	【Note2,4】
Response Time	Rise	r	=0 °	-	5	-	ms	【Note3,4】
	Decay	d		-	20	-	ms	
Chromaticity of white	Wx	Wy	=0 °	0.283	0.313	0.343	-	【Note4】
	0.299			0.329	0.359	-		
Chromaticity of red	Rx	Ry	=0 °	0.577	0.607	0.637	-	-
	0.309			0.339	0.369	-		
Chromaticity of green	Gx	Gy	=0 °	0.257	0.287	0.317	-	-
	0.567			0.597	0.627	-		
Chromaticity of Blue	Bx	By	=0 °	0.115	0.145	0.175	-	-
	0.057			0.087	0.117	-		
Luminance of white	Y <sub>L</sub>	=0 ° (Dimmer:Max.)	210	225	-	cd/m <sup>2</sup>	【Note4】	
		=0 ° (Dimmer:Min.)	-	22.5	27			
White Uniformity		w	=0 °	-	-	1.25	-	【Note5】

The measurement shall be executed 30 minutes after lighting at rating.

The optical characteristics shall be measured in a dark room or equivalent state with the method shown in Fig.2 below.

1

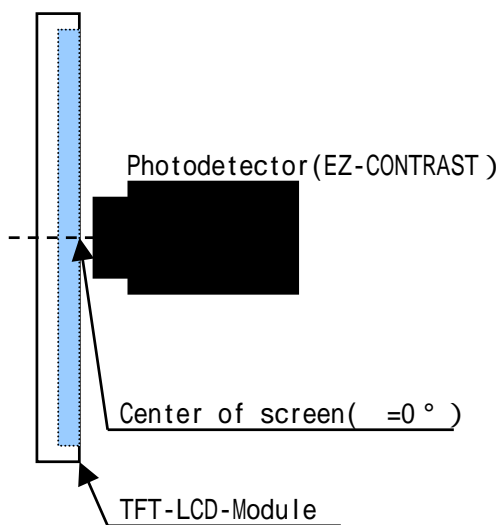

Fig2-1 Viewing angle measurement method

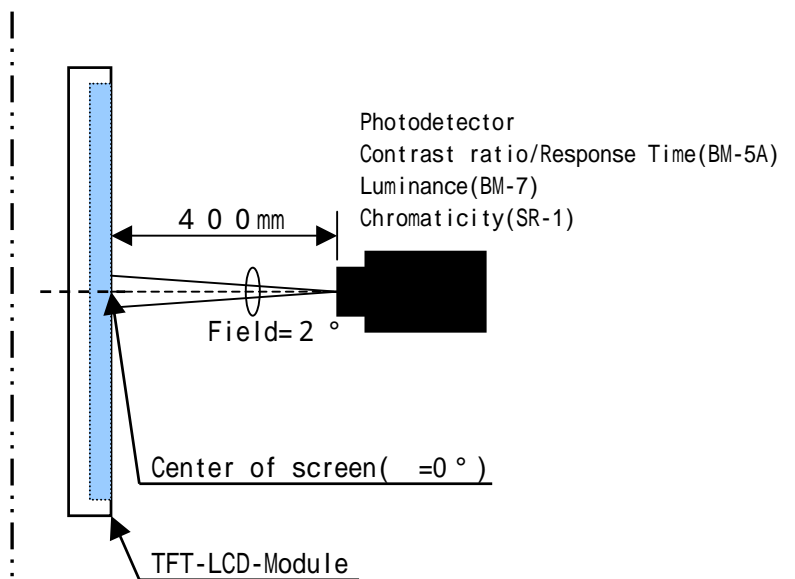
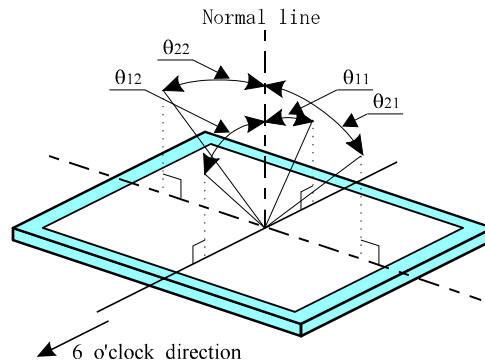

Fig2-2 Luminance/Contrast ratio/Response time/Chromaticity measurement method

Fig2 Optical characteristics measurement method

**【Note1】** Definitions of viewing angle range



**【Note2】** Definition of contrast ratio:

The contrast ratio is defined as the following.

$$\text{Contrast Ratio (CR)} = \frac{\text{Luminance (brightness) with all pixels white}}{\text{Luminance (brightness) with all pixels black}}$$

**【Note3】** Definition of response time:

The response time is defined as the following figure and shall be measured by switching the input signal for "black" and "white".

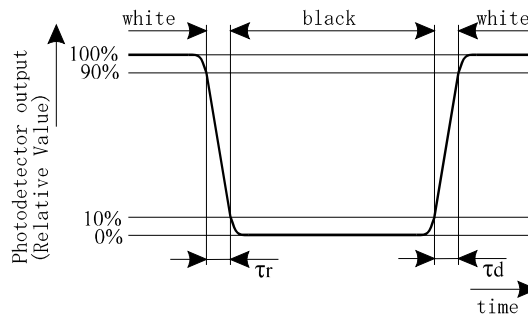

**【Note4】** This shall be measured at center of the screen.

**【Note5】** Definition of white uniformity:

White uniformity is defined as the following with five measurements (A ~ E).

$$w = \frac{\text{Maximum Luminance of five points (brightness)}}{\text{Minimum Luminance of five points (brightness)}}$$

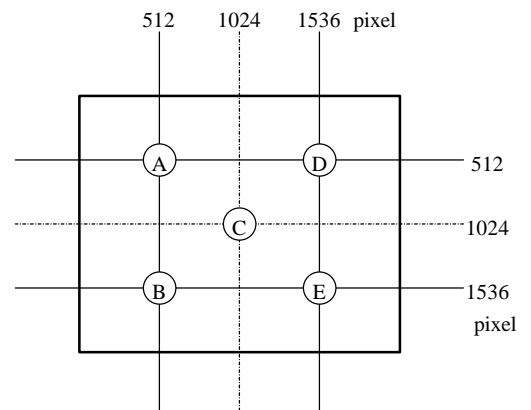

## 10. Handling Precautions

- a) Be sure to turn off the power supply when inserting or disconnecting the cable from the input connector.
- b) Be sure to design the cabinet so that the module can be installed without any extra stress such as warp or twist.
- c) Since the front polarizer is easily damaged, pay attention for handling.
- d) The adhesion of water to the module may cause discoloration or spots. Wipe it off immediately.
- e) In case the panel surface is soiled, wipe it with absorbent cotton or other soft cloth.
- f) Since the panel is made of fine wires on glass, it may break or crack if dropped or bumped on hard surface. Handle with care.
- g) Since CMOS LSI is used in this module, take care of static electricity and take the human earth into consideration when handling.
- h) Make sure the four mounting holes of the module are grounded sufficiently. Take electro-magnetic interference (EMI) into consideration.
- i) The module has some printed circuit boards (PCBs) on the back. Be sure to avoid them from any stress or pressure during the handling or installing of the module; otherwise some of electronic parts on the PCBs may be damaged.
- j) Observe all other precautionary requirements in handling components.
- k) When some pressure is added on the module from rear side constantly, it causes display non-uniformity issue, functional defect, etc. So, please avoid such design.
- l) When giving a touch to the panel while turning on the power supply, it may cause degradation. In that case, once turn off the power supply, and turn on again after several seconds, and then degradation is disappeared a few seconds after turning on again.
- m) When handling LCD modules and assembling them into cabinets, please be noted that long-term storage in the environment of oxidization or deoxidization gas and the use of such materials as reagent, solvent, adhesive, resin, etc. which generate these gasses, may cause corrosion and discoloration of the LCD modules.

## 11. Shipping condition 2

- a) Maximum number of carton over which can be stacked: maximum 2 cartons
- b) Maximum quantity in a carton : 2 set
- c) Carton size : 794(W)\*399(H)\*866(D) mm
- d) Gross weight for 2 set : maximum 43 kg

Packing drawing is shown in Fig. 3.

## 12 . Reliability test items

No.	Test item	Conditions
1	High temperature storage test	Ta=60 240h
2	Low temperature storage test	Ta=-25 240h
3	High temperature & high humidity operation test	Ta=40 ; 95%RH 240h (No condensation)
4	High temperature operation test	Ta=40 240h (The panel temp. must be less than 60 )
5	Low temperature operation test	Ta=0 240H
6	Vibration test (non- operating)	Frequency : 10 ~ 57Hz/Vibration width (one side) : 0.075mm : 58 ~ 500Hz/Gravity : 9.8m/s <sup>2</sup> Sweep time : 11 minutes Test period : 3 hours (1 hour for each direction of X,Y,Z)
7	Shock test (non- operating)	Max. gravity : 196m/s <sup>2</sup> Pulse width : 11ms, sine wave Direction : ± X, ± Y, ± Z, once for each direction.

**【Result Evaluation Criteria】**

Under the display quality test conditions with normal operation state, these shall be no change that may affect practical display function.

13 . Others

1) Lot No. and indication Label:

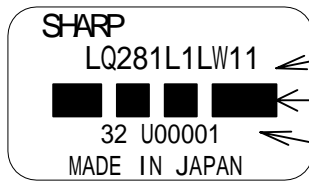

Model No.

Bar Code (Lot No.)

Lot No.

【How to express Lot No.】

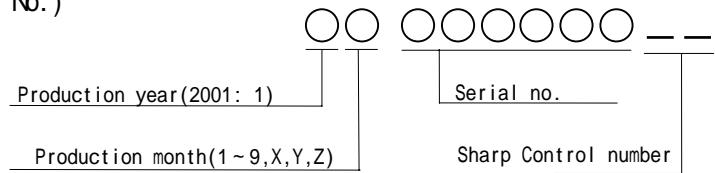

2) Packing Label

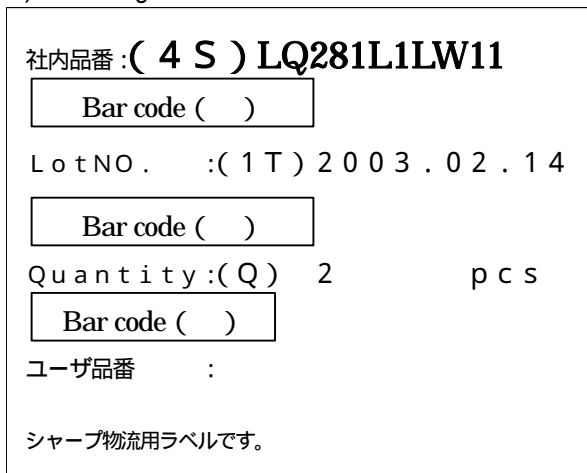

Model No. (LQ281L1LW11)

Lot No. (Date)

Quantity

- 3) Adjusting volume have been set optimally before shipment, so do not change any adjusted value.  
If adjusted value is changed, the specification may not be satisfied.
- 4) Disassembling the module can cause permanent damage and should be strictly avoided.
- 5) Please be careful since image retention may occur when a fixed pattern is displayed for a long time.
- 6) The chemical compound which causes the destruction of ozone layer is not being used.
- 7) Warning of mercury and material information of LPG(Light Pipe Guide) are labeled on the back of the module.

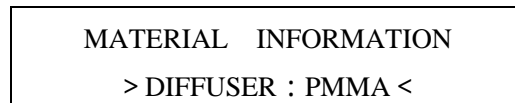

- 8) Cold cathode fluorescent lamp in LCD PANEL contains a small amount of mercury, Please follow local ordinances or regulations for disposal. (put on the back of the module. Size: 63 × 25.5mm )

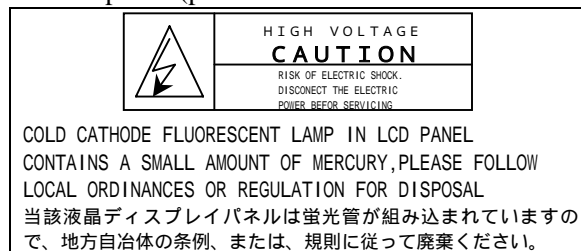

- 9) When any question or issue occurs, it shall be solved by mutual discussion.

## Carton storage condition

Temperature : 0 to 40

Humidity : 95%RH or less

Reference condition : 20 to 35 , 85%RH or less (summer)

: 5 to 15 , 85%RH or less (winter)

• the total storage time (40 ,95%RH) : 240H or less

Sunlight : Be sure to store in unpacked condition or at dark room to avoid direct sunlight.

Atmosphere: : Never leave in a corrosive atmosphere and/or an area that volatile liquids are generated.

## Cautions as to condensation:

- Do not put the carton directly on the floor. Be sure to keep on pallet or stand.

Also, to keep the ventilation of the bottom of pallet/stand well, be sure to place in the same direction properly.

-Be sure to keep away from the wall of warehouse.

- Please take care of ventilation in warehouse by using ventilation system.

- Control the ambient temperature to avoid sudden temperature change.

Storage period : 1 year, in the above conditions.

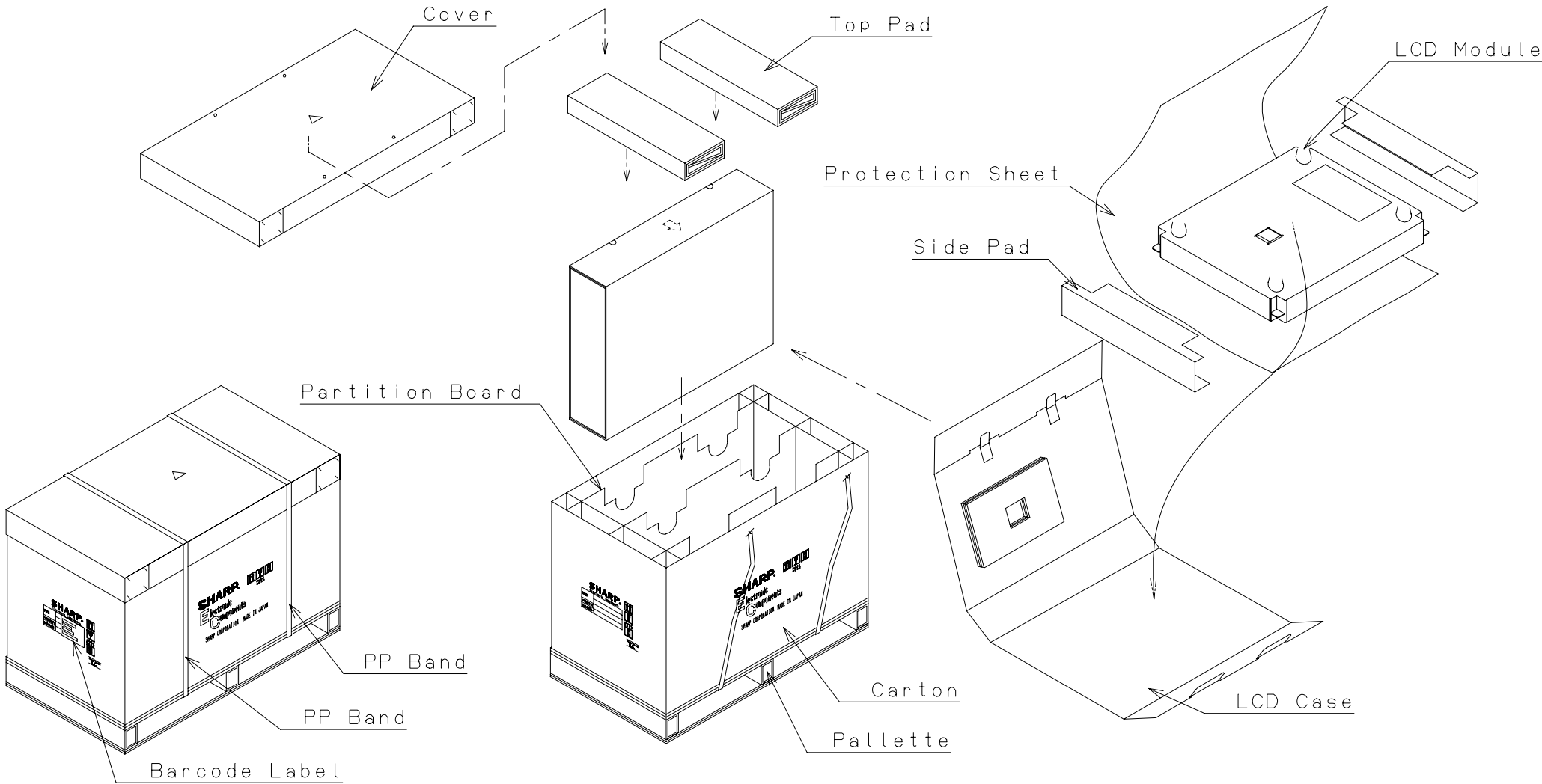

▲2 Fig. 3 Packing form



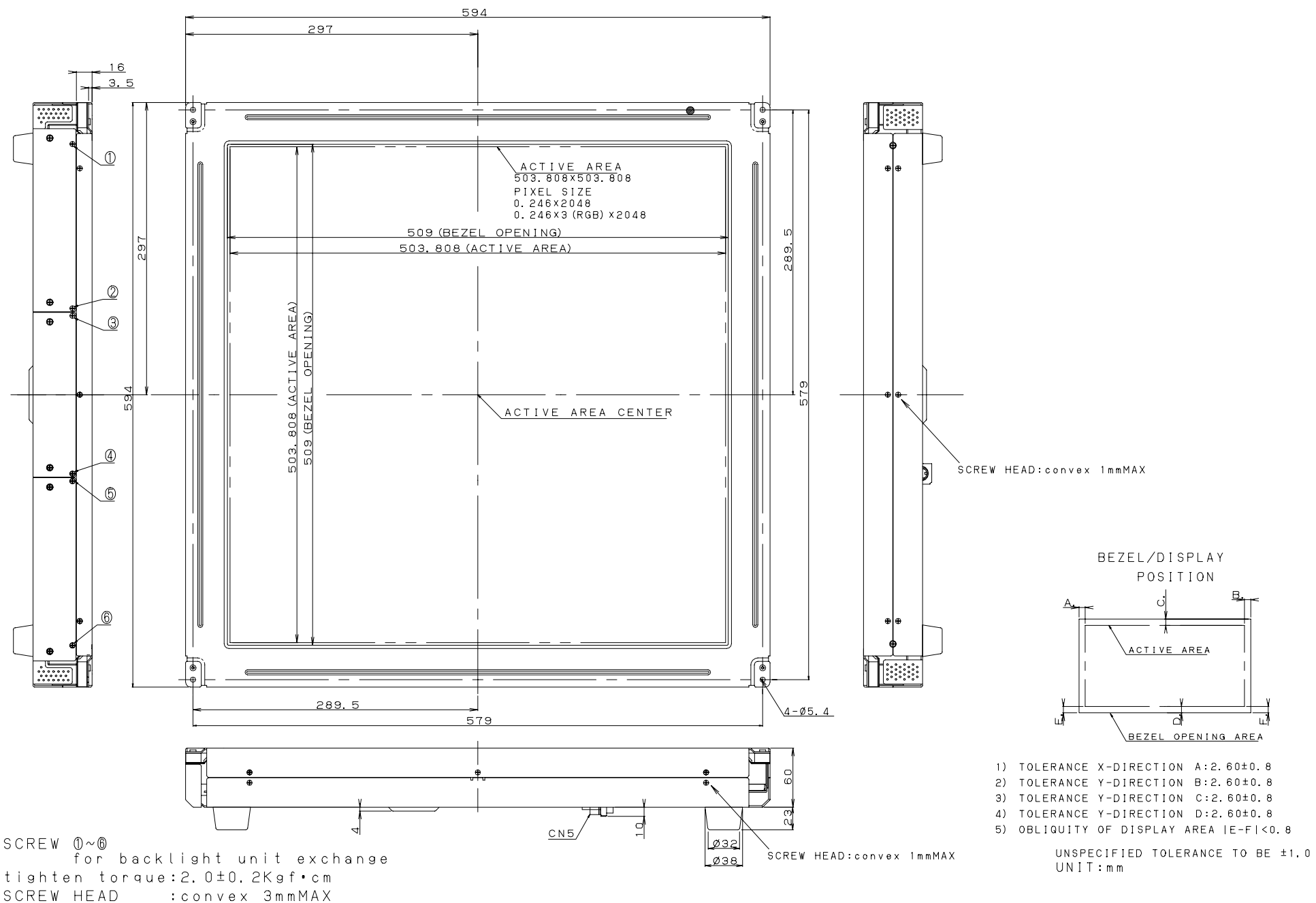

▲2 2005. 07. 01  
▲1 2003. 04. 10  
2003. 02. 27

Fig. 4 LQ281L1LW11 MODULE OUTLINE 1/2

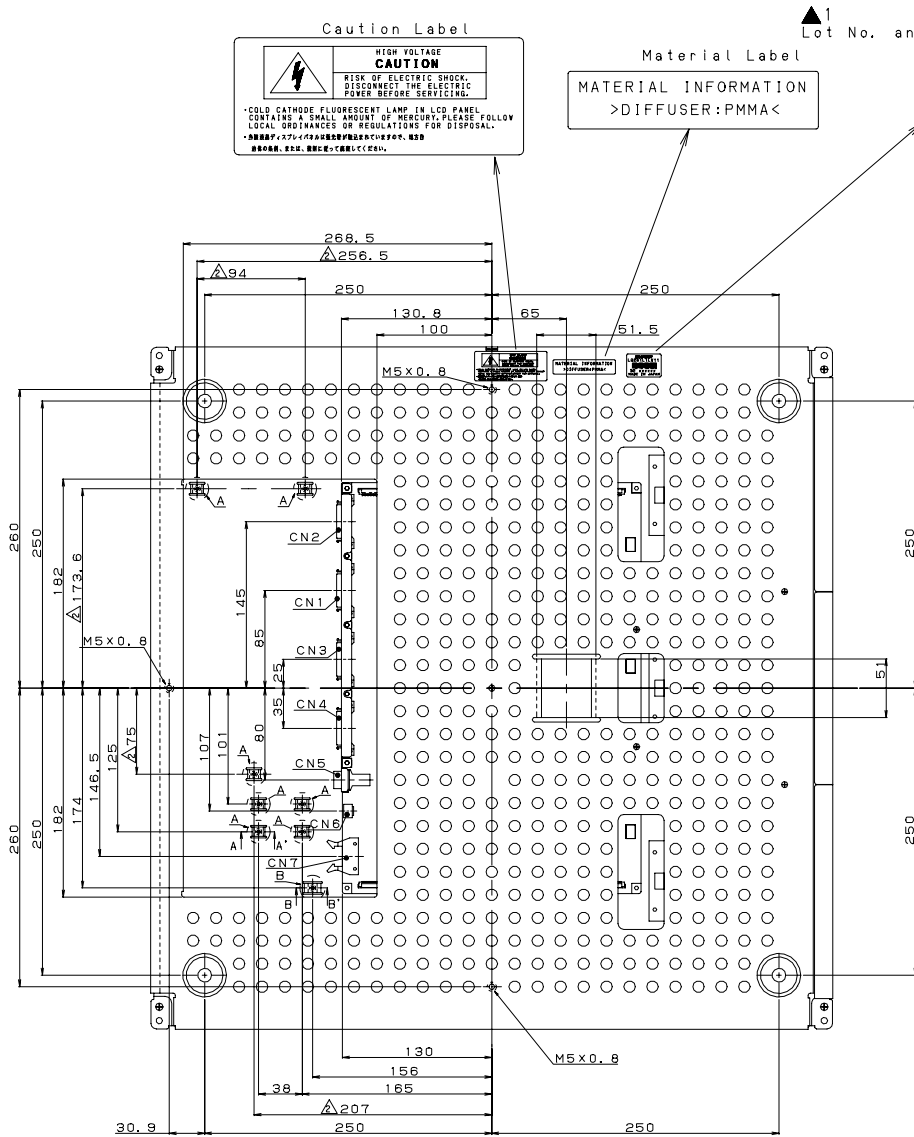

**Caution Label**

**HIGH VOLTAGE CAUTION**

RISK OF ELECTRIC SHOCK. DISCONNECT THE ELECTRIC POWER BEFORE SERVICING.

•COLD CATHODE FLUORESCENT LAMP IN LCD PANEL CONTAINS A SMALL AMOUNT OF MERCURY. PLEASE FOLLOW LOCAL ORDINANCES OR REGULATIONS FOR DISPOSAL.

•環境省資源再生センター指定品

•環境省資源再生センター指定品

**Material Label**

MATERIAL INFORMATION  
>DIFFUSER:PMMA<

**Lot No. and indication Label**

SHARP  
LQ281L1LW11  
32 xxxxxx  
MADE IN JAPAN

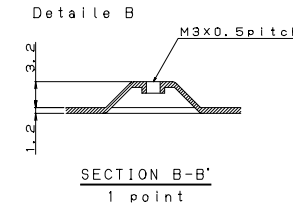
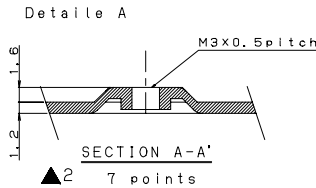

I/F Signal CN1~CN4 (Display Area A, B, C, D) : 10240-1210VE (3M)  
 Power supply CN5 : RP13A-12RC-20PB (HIROSE ELECTRIC Co., Ltd)  
 Adjustment of Luminance CN6 : S5B-PH-SM3-TB (J. S. T. Co. Ltd)  
 Detection of an abnormality CN7 : HIF3BA-10PA-2.54DS (HIROSE ELECTRIC Co., Ltd)

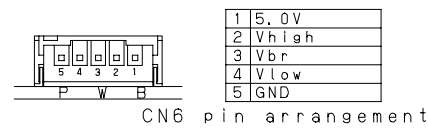
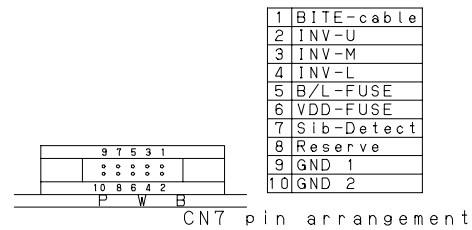
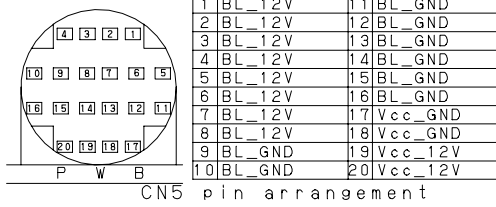
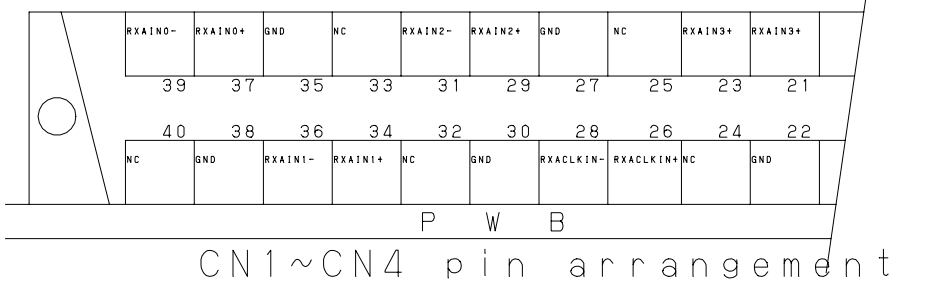
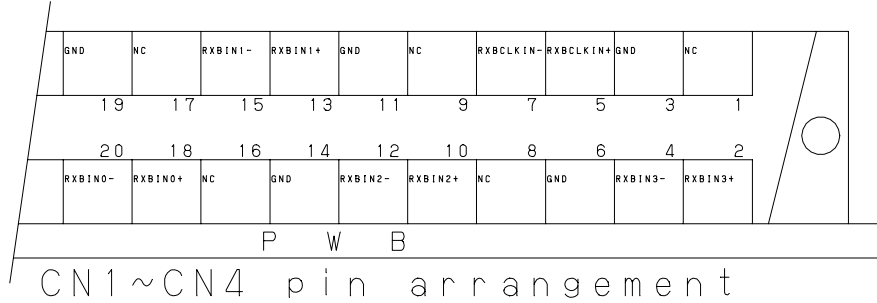
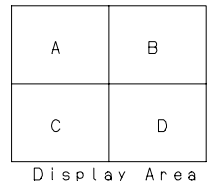

▲2 2005. 07. 01  
 ▲1 2003. 04. 10  
 2003. 02. 27

Fig. 5 LQ281L1LW11 MODULE OUTLINE 2/2

**SPECIFICATIONS ARE SUBJECT TO CHANGE WITHOUT NOTICE.**

Suggested applications (if any) are for standard use; See Important Restrictions for limitations on special applications. See Limited Warranty for SHARP's product warranty. The Limited Warranty is in lieu, and exclusive of, all other warranties, express or implied. ALL EXPRESS AND IMPLIED WARRANTIES, INCLUDING THE WARRANTIES OF MERCHANTABILITY, FITNESS FOR USE AND FITNESS FOR A PARTICULAR PURPOSE, ARE SPECIFICALLY EXCLUDED. In no event will SHARP be liable, or in any way responsible, for any incidental or consequential economic or property damage.

---

# SHARP®

---

## NORTH AMERICA

SHARP Microelectronics of the Americas  
5700 NW Pacific Rim Blvd.  
Camas, WA 98607, U.S.A.  
Phone: (1) 360-834-2500  
Fax: (1) 360-834-8903  
Fast Info: (1) 800-833-9437  
www.sharpsma.com

---

## EUROPE

SHARP Microelectronics Europe  
Division of Sharp Electronics (Europe) GmbH  
Sonninstrasse 3  
20097 Hamburg, Germany  
Phone: (49) 40-2376-2286  
Fax: (49) 40-2376-2232  
www.sharpsme.com

---

## JAPAN

SHARP Corporation  
Electronic Components & Devices  
22-22 Nagaike-cho, Abeno-Ku  
Osaka 545-8522, Japan  
Phone: (81) 6-6621-1221  
Fax: (81) 6117-725300/6117-725301  
www.sharp-world.com

---

## TAIWAN

SHARP Electronic Components  
(Taiwan) Corporation  
8F-A, No. 16, Sec. 4, Nanking E. Rd.  
Taipei, Taiwan, Republic of China  
Phone: (886) 2-2577-7341  
Fax: (886) 2-2577-7326/2-2577-7328

---

## SINGAPORE

SHARP Electronics (Singapore) PTE., Ltd.  
438A, Alexandra Road, #05-01/02  
Alexandra Technopark,  
Singapore 119967  
Phone: (65) 271-3566  
Fax: (65) 271-3855

---

## KOREA

SHARP Electronic Components  
(Korea) Corporation  
RM 501 Geosung B/D, 541  
Dohwa-dong, Mapo-ku  
Seoul 121-701, Korea  
Phone: (82) 2-711-5813 ~ 8  
Fax: (82) 2-711-5819

---

## CHINA

SHARP Microelectronics of China  
(Shanghai) Co., Ltd.  
28 Xin Jin Qiao Road King Tower 16F  
Pudong Shanghai, 201206 P.R. China  
Phone: (86) 21-5854-7710/21-5834-6056  
Fax: (86) 21-5854-4340/21-5834-6057

**Head Office:**

No. 360, Bashen Road,  
Xin Development Bldg. 22  
Waigaoqiao Free Trade Zone Shanghai  
200131 P.R. China  
Email: smc@china.global.sharp.co.jp

---

## HONG KONG

SHARP-ROXY (Hong Kong) Ltd.  
3rd Business Division,  
17/F, Admiralty Centre, Tower 1  
18 Harcourt Road, Hong Kong  
Phone: (852) 28229311  
Fax: (852) 28660779  
www.sharp.com.hk  
**Shenzhen Representative Office:**  
Room 13B1, Tower C,  
Electronics Science & Technology Building  
Shen Nan Zhong Road  
Shenzhen, P.R. China  
Phone: (86) 755-3273731  
Fax: (86) 755-3273735