

# LQ150X1KW31

## TFT LCD Module

(Model No.: LQ150X1KW31)

Spec. Issue Date: June 14, 2002

---

PREPARED BY :      DATE	 TFT Liquid Crystal Display Group SHARP CORPORATION  SPECIFICATION	SPEC No. LD-14506A
		FILE No.
APPROVED BY :      DATE		ISSUE : Jun. 14 2002
		PAGE : 21 pages
		APPLICABLE GROUP AVC Liquid Crystal Display Group

DEVICE SPECIFICATION FOR

# TFT-LCD Module

MODEL No.

# LQ150X1KW31

CUSTOMER'S APPROVAL

DATE \_\_\_\_\_

BY \_\_\_\_\_

PRESENTED

BY

Y. Inaba

Assistant Department General Manager

Development Engineering Department 2

AVC LIQUID CRYSTAL Division

AVC LIQUID CRYSTAL DISPLAY GROUP

SHARP CORPORATION



## 1. Application

This specification applies to a color TFT-LCD module, LQ150X1KW31 (15"XGA all in one module.).

- ◎These specification sheets are the proprietary product of SHARP CORPORATION("SHARP) and include materials protected under copyright of SHARP. Do not reproduce or cause any third party to reproduce them in any form or by any means, electronic or mechanical, for any purpose, in whole or in part, without the express written permission of SHARP .
- ◎The device listed in these technical sheets was designed and manufactured for use in OA equipment .
- ◎There are some of graphic cards which do not satisfy a standard. When such a card is used, it may not work properly.
- ◎In case of using the device for applications such as control and safety equipment for transportation(aircraft, trains, automobiles, etc. ), rescue and security equipment and various safety related equipment which require higher reliability and safety, take into consideration that appropriate measures such as fail-safe functions and redundant system design should be taken .
- ◎Do not use the device for equipment that requires an extreme level of reliability, such as aerospace applications, telecommunication equipment(trunk lines), nuclear power control equipment and medical or other equipment for life support .
- ◎SHARP assumes no responsibility for any damage resulting from the use of the device which does not comply with the instructions and the precautions specified in these technical sheets .
- ◎No guarantee for the firmware which is produced/rewritten by the customer.
- ◎Contact and consult with a SHARP sales representative for any questions about this device .

## 2. Overview

This module is a all in one model using a color active matrix LCD module incorporating amorphous silicon TFT (Thin Film Transistor). It is composed of a color TFT-LCD panel, driver ICs, control circuit, power supply circuit, monitor interface circuit, inverter circuit and a back light unit. Graphics and texts can be displayed on a  $1024 \times 3 \times 768$  dots panel with 16.7million colors by supplying analog video input ,with +12V DC supply voltage. It is a wide viewing-angle-module (Vertical viewing angle:  $170^\circ$  Horizontal viewing angle:  $170^\circ$  ,  $CR \geq 10$ ). This LCD module with new color filter is suitable for the LCD monitor applications where high vivid color saturation, and high color depth are very important.

## 3. Mechanical Specifications

Parameter	Specifications	Unit
Display size	38 (Diagonal)	cm
	15.0 (Diagonal)	inch
Active area	304.1 (H) $\times$ 228.1 (V)	mm
Pixel format	1024 (H) $\times$ 768 (V)	pixel
	(1 pixel=R+G+B dots)	
Pixel pitch	0.297 (H) $\times$ 0.297 (V)	mm
Pixel configuration	R,G,B vertical stripe	
Display mode	Normally black	
Unit outline dimensions	346.0 (W) $\times$ 255.0 (H) $\times$ 22.3 (D)	mm
Mass	1,700 (Maximum)	g
Surface treatment	Anti-glare and hard-coating 2H (Haze value = 28)	



\*1.Note: outline dimension is shown in Fig. 1 , Fig. 2

4. Block Diagram (Fig. 3)

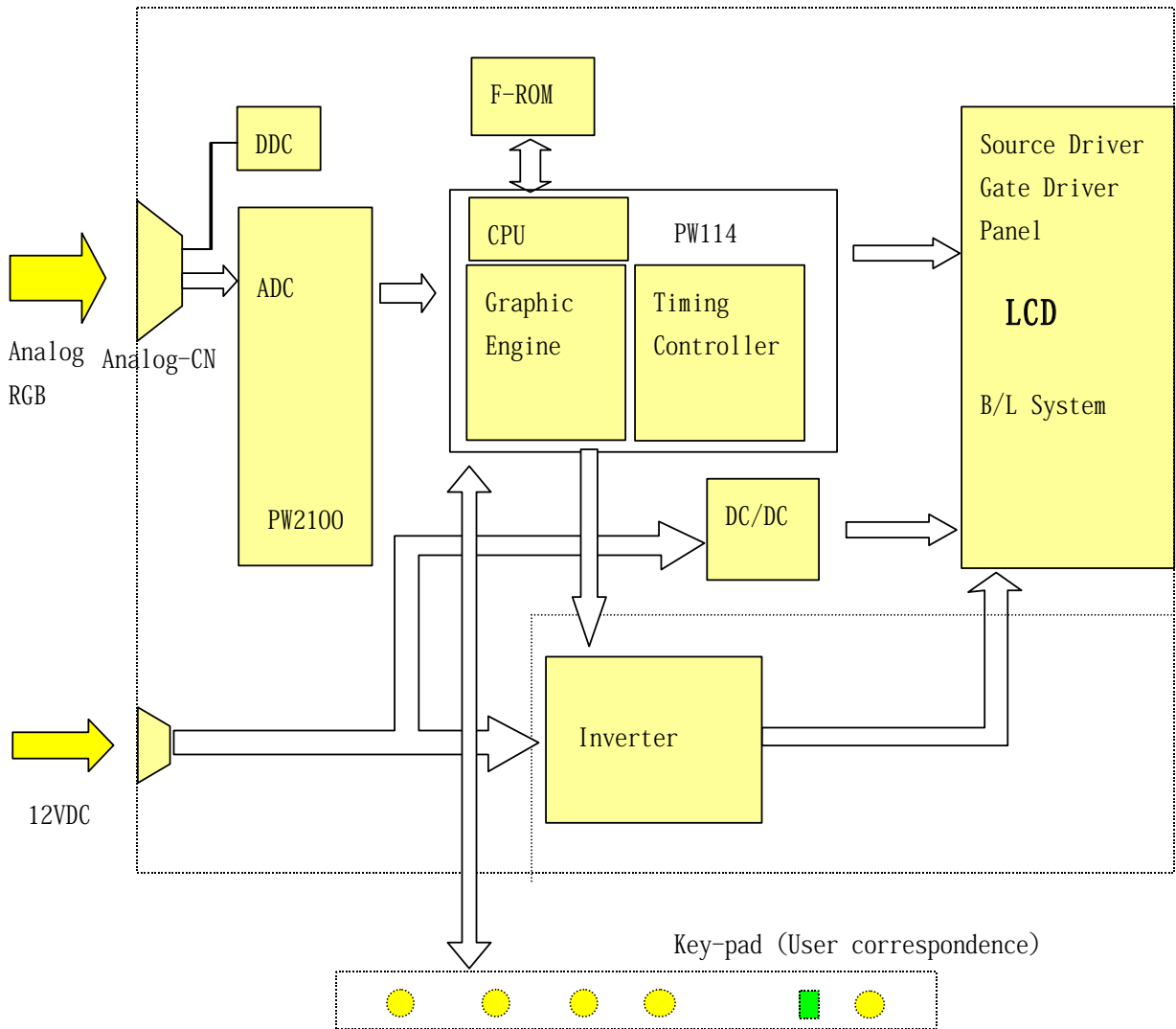

## 5. Input Terminals

## 5-1. Analog video input

CN1

The module-side connector : S15B-PH-SM3(JST)

The user-side connector : PHR-15(JST)

Pin No.	Symbol	Signal	Remark
1	RV	Red Video	
2	RG	Red GND	
3	GV	Green Video	
4	GG	Green GND	
5	BV	Blue Video	
6	BG	Blue GND	
7	+5V	+5VDC (for cable detect)	
8	SDA	Bidirectional DDC Data (SDA)	
9	SCL	DDC Data Clock (SCL)	
10	HS	Horizontal Sync	
11	VS	Vertical Sync	
12	GND	Signal GND	
13	GND	Inverter GND	
14	+12V	+12VDC (Signal Power Input)	
15	+12V	+12VDC (Inverter Power Input)	

## 6. Absolute Maximum Ratings

Parameter	Symbol	Condition	Ratings	Unit	Remark
Input voltage (Analog)	$V_{ia}$	Ta=25°C	0 ~ +3.6	V	【Note1】
(Signal)	$V_{is}$	Ta=25°C	-0.3 ~ +5.5	V	【Note1】
+12V supply voltage	$V_{cc}$	Ta=25°C	0 ~ +15	V	
Storage temperature	Tstg	—	-25 ~ +60	°C	【Note2】
Operating temperature (Ambient)	Topa	—	0 ~ +50	°C	

【Note1】 For signals

【Note2】 Humidity : 95%RH Max. ( Ta ≤ 40°C )

Maximum wet-bulb temperature at 39°C or less ( Ta &gt; 40°C )

No condensation.

## 7. Electrical Characteristics

## 7-1. Analog Video Input

Standard : VESA

Analog video signals : 0.7Vp-p 75 Ohm

DDC: L; Max0.8V H; Min2.0V

Other signals : 3.3 and 5V TTL logic families (Separate Sync, Composite Sync)

## 7-3. Power Input

Parameter	Symbol	Min.	Typ.	Max.	Unit	Remark
+12V	Supply voltage	$V_{in}$	11.4	12.0	12.6	V
	Current dissipation	$I_{in}$		1.7	2.0	A
	Ripple Voltage				200	mV

7-4. Back light driving

The back light system is an edge-lighting type with four CCFT (Cold Cathode Fluorescent Tube).

The characteristics of the lamp are shown in the following table .

The value mentioned below is at the case of one CCFT .

Parameter	Symbol	Min.	Typ.	Max.	Unit	Remark
Lamp life time	L <sub>L</sub>	50000	—	—	hour	【Note1】

【Note1】 Lamp life time is defined as the time when either ① or ② occurs in the continuous operation under the condition of Ta=25°C and IL=6.2 mArms.

- ① Brightness becomes 50% of the original value under standard condition .
- ② Kick-off voltage at Ta=0°C exceeds maximum value, 1400Vrms .

8. VESA DPMS FUNCTIONALITY

VESA DPMS specification

9. Display Resolution

Vertical frequency : From 58 to 75.03Hz

Horizontal frequency : From 31.47 to 60 KHz

If the input frequency is out of the above-specified range, the Smart Panel shall display a warning screen

Is out of the range above-specified range

Timing characteristics of input signals factory preset display mode

**FACTORY PRESET DISPLAY MODES**

Preset	Pixel Format	H-Freq (KHz)	H Polarity	V-Freq (Hz)	V Polarity	Pixel Clk (MHz)	Source
1	640 x 350	31.47	+	70.09	-	25.175	VGA
2	640 x 480	31.47	-	59.94	-	25.175	VGA
3	640 x 480	37.50	-	75.00	-	31.500	VESA
4	720 x 400	31.47	-	70.08	+	28.321	VGA
5	800 x 600	37.88	+	60.32	+	40.000	VESA
6	800 x 600	46.88	+	75.00	+	49.500	VESA
7	832 x 624	49.72	+/-	74.55	+/-	57.283	MAC
8	1024 x 768	48.36	-	60.00	-	65.000	VESA
9	1024 x 768	56.50	-	70.00	-	75.000	VESA
10	1024 x 768	60.02	+	75.03	+	78.750	VESA



## 10.CONTROLLER FUNCTION

/Video Stretching and Down Scaling

/Auto Correction -- display size, position, clock, Phase adjustment

/Panel Timing and Interface

/Controller ASICS -PW114

11. Output for Key-pad for Operation (C N 4)

Connector : SD53261-1510 (molex)

No	Name	Signal	Key Function
1	N.C.	N.C.	
2	N.C.	N.C.	
3	N.C.	N.C.	
4	GND	GND	
5	LEDG-ON	Green LED ON SIGNAL	
6	LEDO-ON	Red LED ON SIGNAL	
7	N.C.	N.C.	
8	N.C.	N.C.	
9	KB5	Key Input 5	SELECT
10	KB4	Key Input 4	-
11	KB3	Key Input 3	+
12	KB2	Key Input 2	MENU
13	KB1	Key Input 1	POWER
14	N.C.	N.C.	
15	+5V	+5V output	

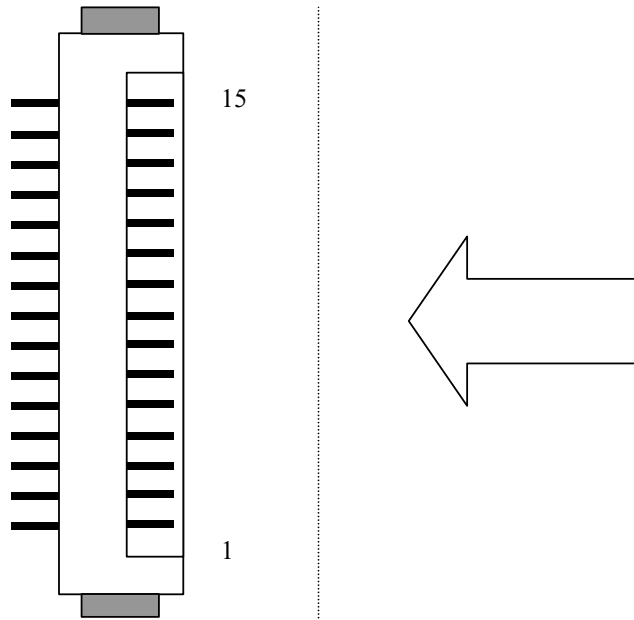

Fig. 4

## 12. OSD MENU

MENU	FUNCTION		Analog Input	REMARK
MENU1 ADJUSTMENT	MANUAL	CLOCK	*	
		PHASE	*	
		H-POS	*	
		V-POS	*	
	AUTO		*	Auto Adjust
MENU2 GAIN CONTROL	MANUAL	BLACK LEVEL	*	
		CONTRAST	*	
	AUTO		*	Auto Adjust
MENU3 WHITE BALANCE			*	5 step COOL-STD-WARM, USER
MENU4 MODE SELECT	OSD H-POSITION		*	
	OSD V-POSITION		*	
	400 LINE		*	
	EXPAND		*	
	SCALING		*	
	LANGUAGE		*	English, Deutsch, Español, Français , Italiano, Nether land, Svenska

## (Key Function)

\* MENU : Change “OSD Menu” (MENU1 – MENU4)

\* SELECT : Select items on OSD

\* + : When OSD Menu is not displayed = Increase brightness

When OSD Menu is displayed = Change value on OSD

\* - : When OSD Menu is not displayed = Decrease brightness

When OSD Menu is displayed = Change value on OSD

### 13. Operation method of OSD

- 1) To use auto adjustment” at first. (13-4-1)
- 2) To use manual adjustment, if necessary. (13-4-2)

[Memo]

Adjustment record can be sustained even after the power- off. (However, it might not be sustained if the power is turned off when the adjustment menu is shown on the display.)

#### 13-1. Backlight Brightness Adjustment

User needs to operate when adjustment menu is not shown on display. If the adjustment menu is shown on the display, the user needs to press “MENU” button (some times, occasionally) to disappear it, at first.

<Manual Adjustment>

- i) To press “-“ or “+” button when the adjustment menu is not shown on the display.



- ii) To press “-“ button (for darker image), or “+” button (for brighter) for the adjustment.  
The adjustment bar automatically disappears some seconds after the user’s last operation.

#### 13-2. Adjustment Lock Function

The operation buttons can be locked (Lock Function) to avoid the change after the completion of the adjustment

- i) To turn off the power supply of main body.
- ii) To press the power supply button (to turn on ) with “MENU” button pushed. Please press the button continuously until message is appeared on the display.

When the lock function is not activated...

The lock function becomes activated with “ADJUSTMENT LOCKED” shown on the display.

When the lock function is activated...

The lock function becomes cancelled with “ADJUSTMENT UNLOCKED” shown on the display

[MEMO]

When the lock function is activated, the buttons except for the power button can not be worked out.

**13-3. Reset of adjustment value**

<Reset of ADJUSTMENT menu>

The adjustment value of ADJUSTMENT menu can be returned back to the initial condition, which was set up in the time of the factory's shipping.

i) To turn on the power supply.

ii) To press both "MENU" button and "-" button. Reset is completed with "RESET" shown on the display.

<All reset of adjustment value>

All of the adjustment menu can be returned back to the initial condition, which is set up in the time of the factory's shipping.

i) To turn off the power supply.

ii) To press the power supply button (to turn on) with both "MENU" button and "SELECT" button pressed.

Please press the buttons continuously until "ALL RESET" is shown on the display. When "ALL RESET END" is shown, reset is completed.

iii) After reset completed, please turn off the power supply once.

[MEMO]

\* When "ALL RESET" is shown on the display, the operation button can not be worked out.

\* When the adjustment lock is activated, all reset can not be worked out. In this case, please unlock the adjustment lock, at first.

**13-4. Display Imaging Adjustment****13-4-1. Auto adjustment of display**

"CLOCK", "PHASE", "H-POS" (Horizontal position) and "V-POS" (Vertical position) in "ADJUSTMENT" menu are automatically adjusted.

[Memo]

Please make auto adjustment activated before the use when user uses this display for the first time, or when user changed the setting in use.

\* Please show the image, which has cross-lines on display area and white lines on edge of display area, on the display before auto adjustment activated.

<How to adjust>

i) To press “MENU” button. “ADJUSTMENT” menu is shown.

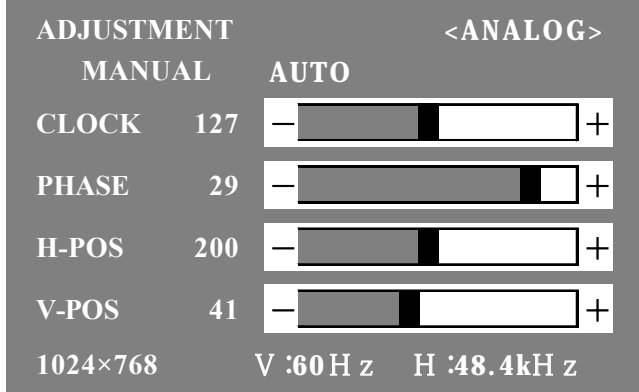

ii) To press “+” button. The display turns black with “ADJUSTING” shown, then comes back to “ADJUSTMENT” menu. (Auto adjustment is completed at this time.)

iii) To press “MENU” button four times so that adjustment menu can disappear.

[Memo]

\* Usually, auto adjustment only is enough to use.

\* In the following case even after auto adjustment made, please use manual adjustment (P.4) if necessary.

/ When user would like to adjust a little more.

/ When computer signal is such as composite sync or sync on green (In this case, it might not be adjusted appropriately by auto adjustment.)

/ When “OUT OF ADJUST” is shown on the display. [Depending on the display image (ex. too dark image), auto adjustment can not be worked out. Please show the image which has brighter lines before auto adjustment activated again.]

### 13-4-2. Manual Adjustment of display

Users can adjust the display image by using the adjustment menu which is prepared.

<Display Image for adjustment>

Please show the image, which has cross-lines on display area and white lines on edge of display area, on the display, and then adjust by seeing the display image.

<How to adjust>

i) To press “MENU” button. “ADJUSTMENT” menu is shown on the display.

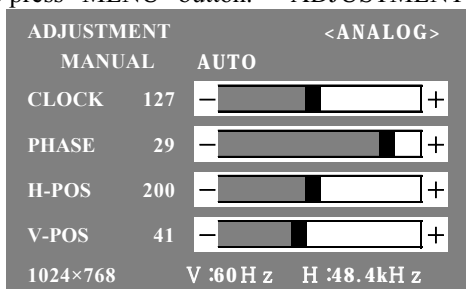

After then, user can adjust the item which needs to be change. Everytime you press “MENU” button, it is switched. (ADJUSTMENT → GAIN CONTROL → WHITE BALANCE → MODE SELECT → to make the menu disappear)

[MEMO]

The adjustment menu automatically disappears approx. 30 seconds after the user’s last operation

<ADJUSTMENT menu>

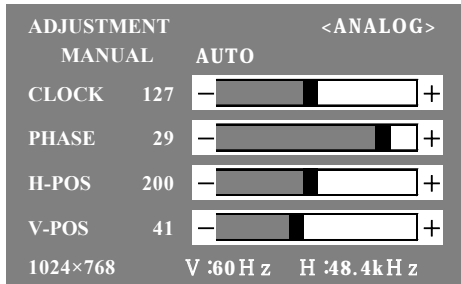

MANUAL...To adjust the item manually which needs to be changed.

AUTO.....,To adjust each item automatically

- \* To select “AUTO” by pressing “+” button.
- \* To select the item : “SELECT” button
- \* To next menu: : “MENU” button

CLOCK

Please adjust to make the noise of vertical strips. (“+” “-“ button)

PHASE

Please adjust to make the noise of horizontal strips. (“+” “-“ button)

- \* Please note that “PHASE” adjustment needs to be after “CLOCK” adjustment done appropriately.

H-POS(Horizontal Position), V-POS(Vertical Position)

Please adjust horizontal(H-POS) and vertical(V-POS) position so that all of the picture can be shown in the display. (“+” “-“ button)

<GAIN CONTROL menu>

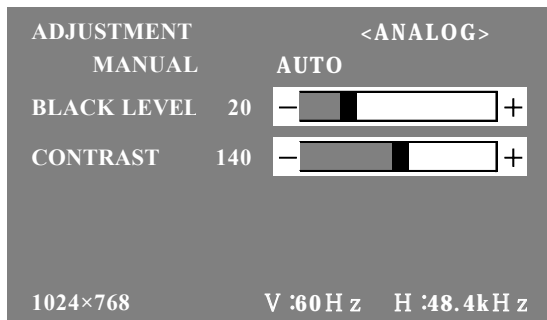

MANUAL...To adjust the item manually which needs to be changed.

AUTO.....,To adjust “BLACK LEVEL” and “CONTRAST” automatically by “Auto Gain Control” function. Please use manual adjustment after auto adjustment, if necessary.

- \* To select “AUTO” by pressing “+” button.

\* To select the item : “SELECT” button

\* To go to next menu : “MENU” button

<“Auto Gain Control” function>

/ Black level and Contrast are adjusted based upon the brightest color and the darkest color in the image shown on display. More than 5mm × 5mm imaging of black and white needs to be shown on the display. Otherwise, it might not be adjusted appropriately.

/ When the signal from computer is composite sync or sync on green, auto adjustment might not be worked out. In the case, please use manual adjustment.

## BLACK LEVEL

Please adjust the brightness of all the display. ( “+” “-“ button)

## CONTRAST

Please adjust so that all of gray scale can be displayed. ( “+” “-“ button)

<WHITE BALANCE menu>

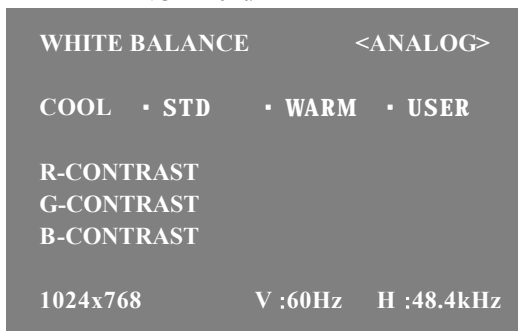

\* Please set up “STD” to show all of gray scale. Without “STD”, all of gray scale can not be shown.

\* To select “COOL”, “·”, “STD”, “·”, “WARM” or “USER” by “+” “-“ button.

\* If “USER” is selected, the setting value of “R-CONTRAST”, “G-CONTRAST” and “B-CONTRAST” is shown, and can be tuned in exactly.

\* To select “R-CONTRAST”, “G-CONTRAST” or “B-CONTRAST” by “SELCT” button.

\* To go to next menu : “MENU” button

COOL..... Bluish from standard

- ..... A little bluish from standard

STD..... Standard setting

- ..... A little reddish from standard

WARM.... Reddish from standard

USER

R-CONTRAST..... Cyan by “-“ button

Red by “+” button

G-CONTRAST..... Magenta by “-“ button

Green by “+” button



B-CONTRAST..... Yellow by “-“ button  
 Blue by “+” button

<MODE SELECT menu>

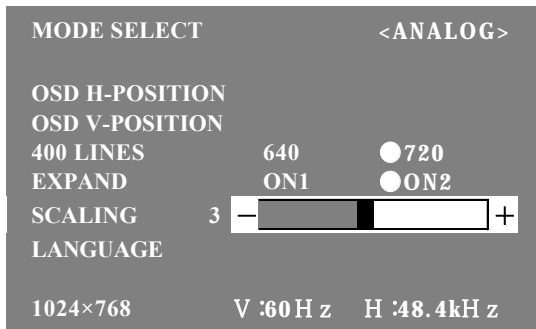

\* Depending on the resolution of input signal, the display condition might not be changed even if the item can be selected.

\* To select the item : SELECT button

\* To finish adjustment : MNU button

#### OSD H-POSITION

To shift the position of adjustment menu horizontally. ( “+” “-“ button)

#### OSD V-POSITION

To shift the position of adjustment menu vertically. ( “+” “-“ button)

#### 400 LINES (resolution)

To set the horizontal resolution of 400 line imaging in PC9800 series and US TEXT etc. ( “+” “-“ button)

640...640×400 dots mode (PC 9800 series etc.)

720...720×400 dots mode (US TEXT etc.)

\* When the input resolution is other than 400 line, user does not need to set because it can be automatically detected.

#### EXPAND

To select the expansion of the display image with less than 1024×768 dots of display mode. (“+” “-“ button)

ON1... To expand with ratio near aspect ratio.

ON2... To expand all parts of the display imaging.

\* When the resolution does not become 1024×768 even after the imaging expansion, the surrounding of display can be shown in black. (This is not out of order.)

#### SCALING

To adjust the sharpness of the expanded display imaging. (“+” “-“ button)

#### LANGUAGE

To change the language used in the adjustment menu.

i)To press “+” button

ii)To select the language by “SELECT” button. Language select menu (“LANGUAGE”) is shown.

iii)To press “MENU” button or “+” button to make the language select menu disappear.

14. Optical Characteristics

Ta=25°C

Parameter		Symbol	Condition	Min.	Typ.	Max.	Unit	Remark
View Angle Range	Horizontal	$\theta 21, \theta 22$	$CR \geq 10$	70	85	—	Deg.	【Note1,4,6】
	Vertical	$\theta 11$		70	85	—	Deg.	
		$\theta 12$		70	85	—	Deg.	
Contrast ratio		C R n	$\theta = 0^\circ$	250	400	—		【Note2,4,6】
Response Time	Rise	$\tau r$		—	20	50	m s	【Note3,4】
	Decay	$\tau d$		—	5	25	m s	
Chromaticity of White		x		0.283	0.313	0.343	—	【Note4,6】
		y		0.299	0.329	0.359	—	
Chromaticity of Red		x		0.607	0.637	0.667	—	【Note4,6】
		y		0.309	0.339	0.369	—	
Chromaticity of Green		x		0.245	0.275	0.305	—	【Note4,6】
		y		0.575	0.605	0.635	—	
Chromaticity of Blue		x		0.115	0.145	0.175	—	【Note4,6】
		y	0.057	0.087	0.117	—		
Luminance of white		$Y_{L1}$	200	250	—	cd/m <sup>2</sup>	【Note4,6】	
White Uniformity		$\delta_w$	—	—	1.25		【Note5】	

※The measurement shall be executed 30 minutes after lighting at rating

※The optical characteristics shall be measured in a dark room or equivalent state with the method Shown in Fig.6 below .

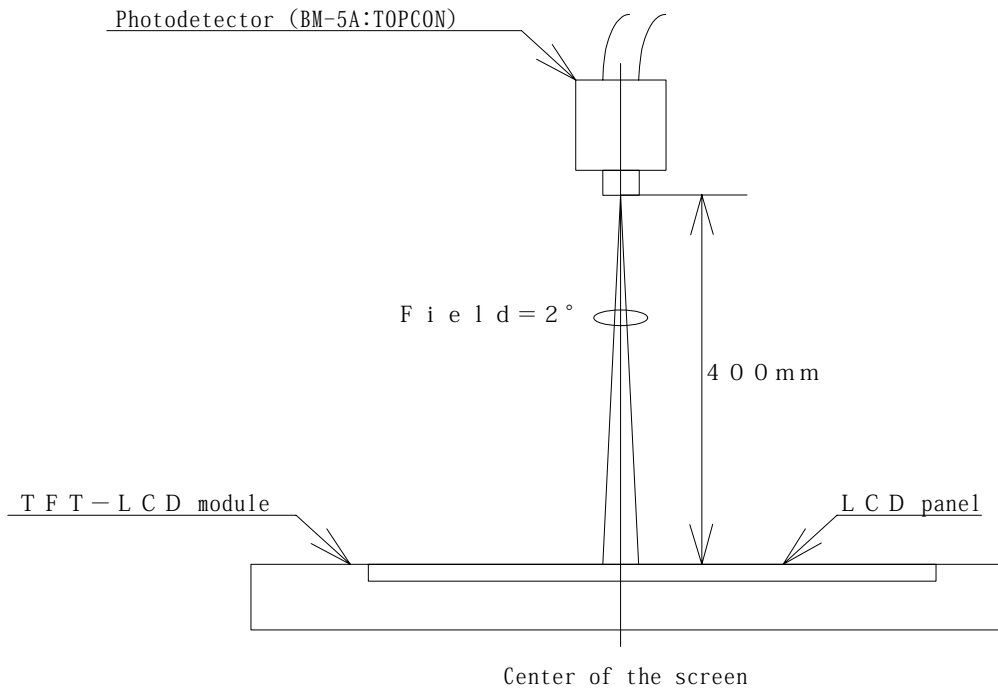
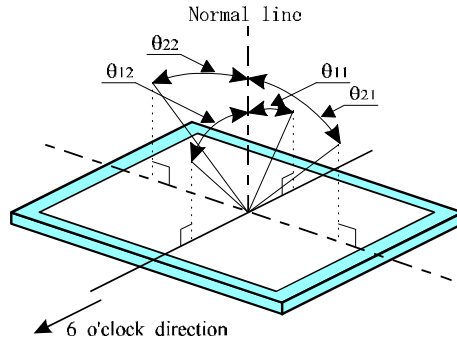

Fig.5 Optical characteristics measurement method

【Note1】 Definitions of viewing angle range:



【Note2】 Definition of contrast ratio:

The contrast ratio is defined as the following.

$$\text{Contrast Ratio (CR)} = \frac{\text{Luminance (brightness) with all pixels white}}{\text{Luminance (brightness) with all pixels black}}$$

【Note3】 Definition of response time:

The response time is defined as the following figure and shall be measured by switching the input signal for "black" and "white".

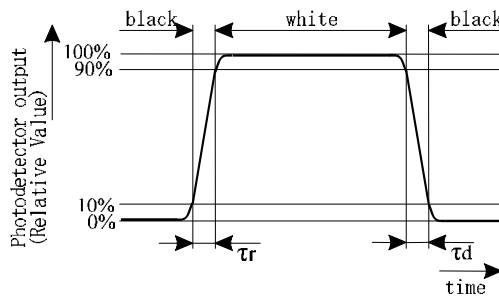

【Note4】 This shall be measured at center of the screen .

【Note5】 Definition of white uniformity:

White uniformity is defined as the following five measurements (A~E) at right figure and calculation with following formula.

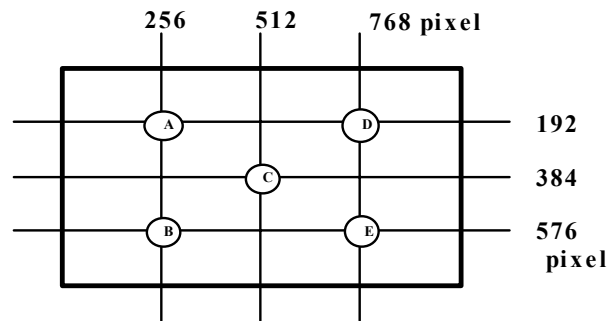

$$\delta_w = \frac{\text{Maximum Luminance of five points (brightness)}}{\text{Minimum Luminance of five points (brightness)}}$$

【Note6】 Measurement Condition

COLOR = STD

## 15. Handling Precautions

- a) Be sure to turn off the power supply when inserting or disconnecting the cable.
- b) Be sure to design the cabinet so that the module can be installed without any extra stress such as warp or twist.
- c) Since the front polarize is easily damaged, pay attention not to scratch it.
- d) Since long contact with water may cause discoloration or spots, wipe off water drop immediately.
- e) When the panel surface is soiled, wipe it with absorbent cotton or other soft cloth. .
- f) Since the panel is made of glass, it may break or crack if dropped or bumped on hard surface. Handle with care.
- g) Since CMOS LSI is used in this module, take care of static electricity and take the human earth into consideration when handling.
- h) Observe all other precautionary requirements in handling components.
- i) This module has its circuitry PCBs on the rear side and should be handled carefully in order not to be stressed.
- j) When some pressure is added onto the module from rear side constantly, it causes display non-uniformity issue, functional defect, etc. So, please avoid such design.
- k) Because Inverter portion use very high voltage, please don't touch when it powered on.

## 17. Packing form

- a) Piling number of cartons : MAX. 5
- b) Package quantity in one carton : 5pcs
- c) Carton size : 317\*272\*409(H)
- d) Packing form drawing : Fig.6

## 16. Reliability test items

No.	Test item	Conditions
1	High temperature storage test	Ta=60°C 240h
2	Low temperature storage test	Ta=-25°C 240h
3	High temperature & high humidity operation test	Ta=40°C ; 95%RH 240h (No condensation)
4	High temperature operation test	Ta=50°C 240h (The panel temp. must be less than 60°C)
5	Low temperature operation test	Ta=0°C 240H
6	Vibration test (non- operating)	Frequency : 10~57Hz/Vibration width (one said) : 0.075mm : 58~500Hz/Gravity : 9.8m/s <sup>2</sup> Sweep time : 11minutes Test period : 3 hours (1 hours for each direction X,Y,Z)
7	Shock test (non- operating)	Max, gravity : 490m/s <sup>2</sup> Pulse width : 11 ms, sine wave Direction : ±X, ±Y, ±Z once for each direction

## 【Result Evaluation Criteria】

Under the display quality test conditions with normal operation state, these shall be no change which may affect practical display function .

17. Others

1) Lot No. and indication Label:

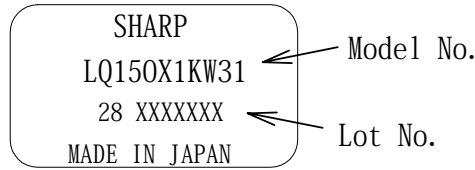

How to express Lot No.

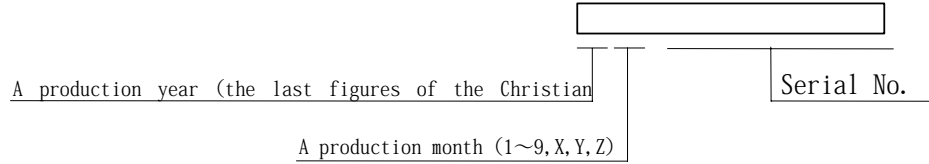

2) Packing box Label

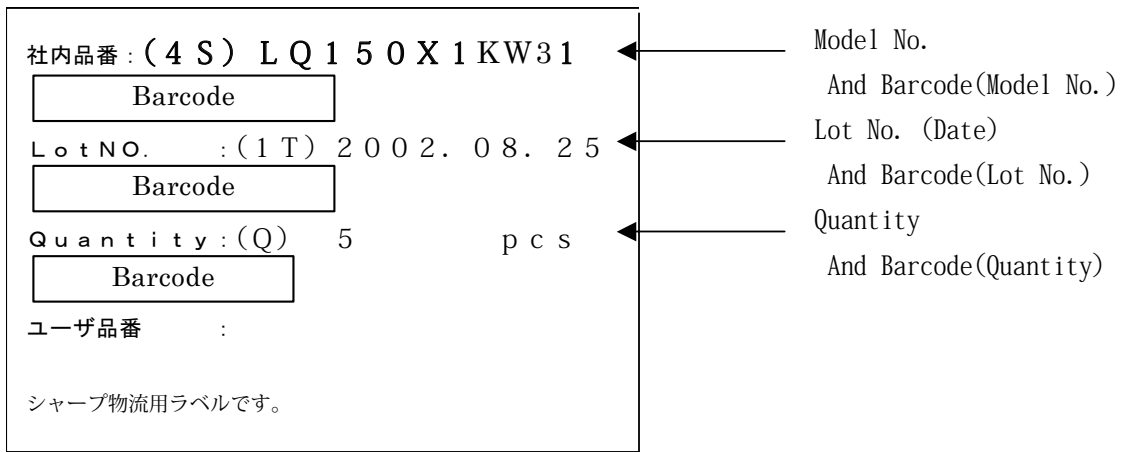

3) Adjusting volume have been set optimally before shipment, so do not change any adjusted value

If adjusted value is changed, the specification may not be satisfied

4) Disassembling the module can cause permanent damage and should be strictly avoided

5) Please be careful since image retention may occur when a fixed pattern is displayed for a long time

6) Chemical compound which causes the destruction of ozone layer is not being used

7) Warning of mercury and material information of LPG(Light Pipe Guide) are labeled on the back of the module.

8) Cold Cathode Fluorescent Lamp in LCD Panel contains a small amount of Mercury , Please follow Local Ordinance or Regulations for disposal

9) If any Problem occurs on relation on the description on this specification , it should be resolved through discussion with spirit of cooperation

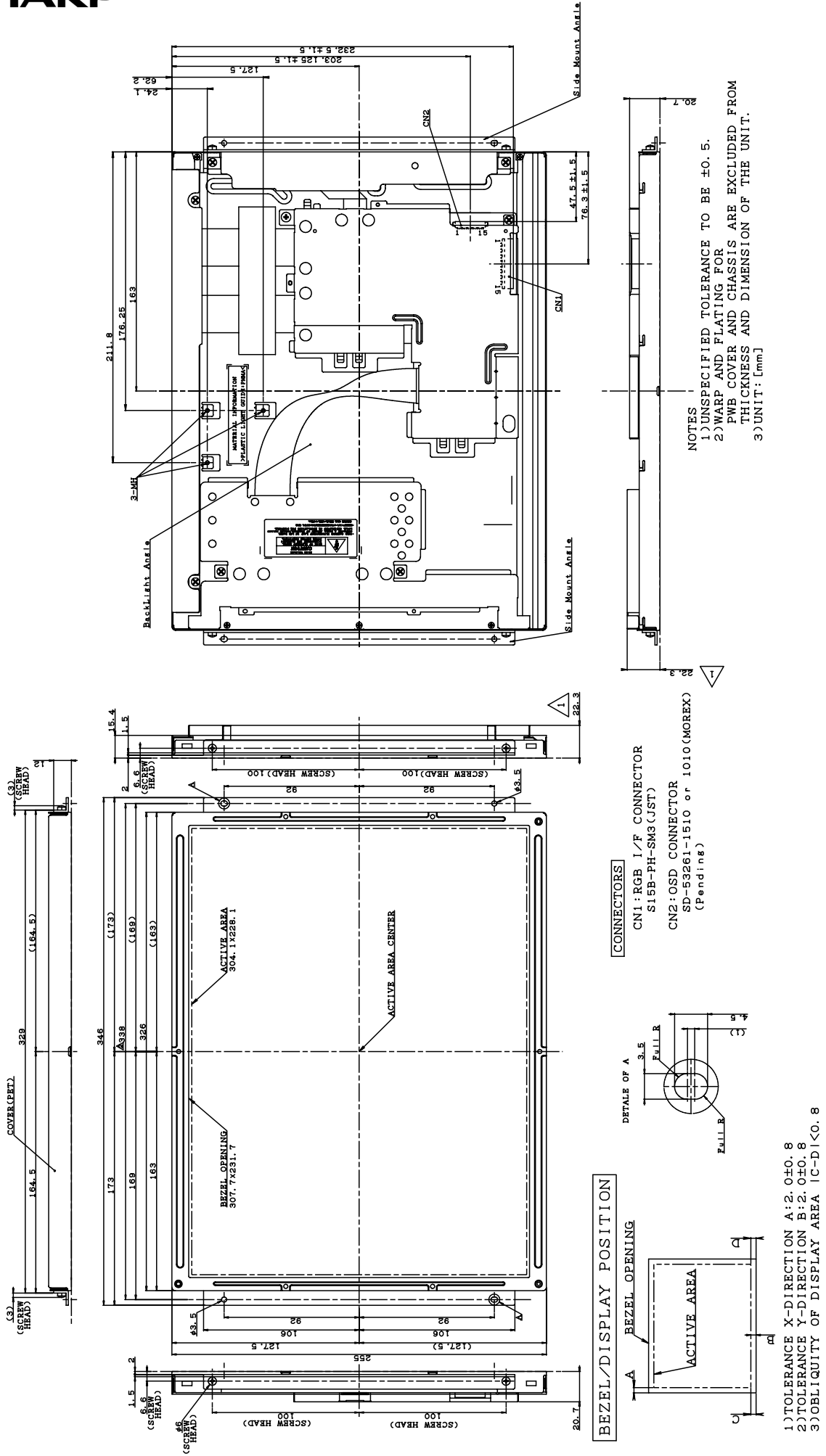

(FRONT SIDE)

(REAR SIDE)

Fig. 1 LQ150X1KW31 OUTLINE DIMENSIONS

1) DRAWING DAY: 2002/06/14

- NOTES
- 1) UNSPECIFIED TOLERANCE TO BE  $\pm 0.5$ .
  - 2) WARP AND FLATING FOR PWB COVER AND CHASSIS ARE EXCLUDED FROM THICKNESS AND DIMENSION OF THE UNIT.
  - 3) UNIT: [mm]

- CONNECTORS
- CN1: RGB I/F CONNECTOR  
S15B-PH-SM3 (JST)
  - CN2: OSD CONNECTOR  
SD-53261-1510 or 1010 (MOREX)  
(Pending)

- BEZEL/DISPLAY POSITION
- 1) TOLERANCE X-DIRECTION A:  $2.0 \pm 0.8$
  - 2) TOLERANCE Y-DIRECTION B:  $2.0 \pm 0.8$
  - 3) OBLIQUITY OF DISPLAY AREA  $1C-D1 < 0.8$



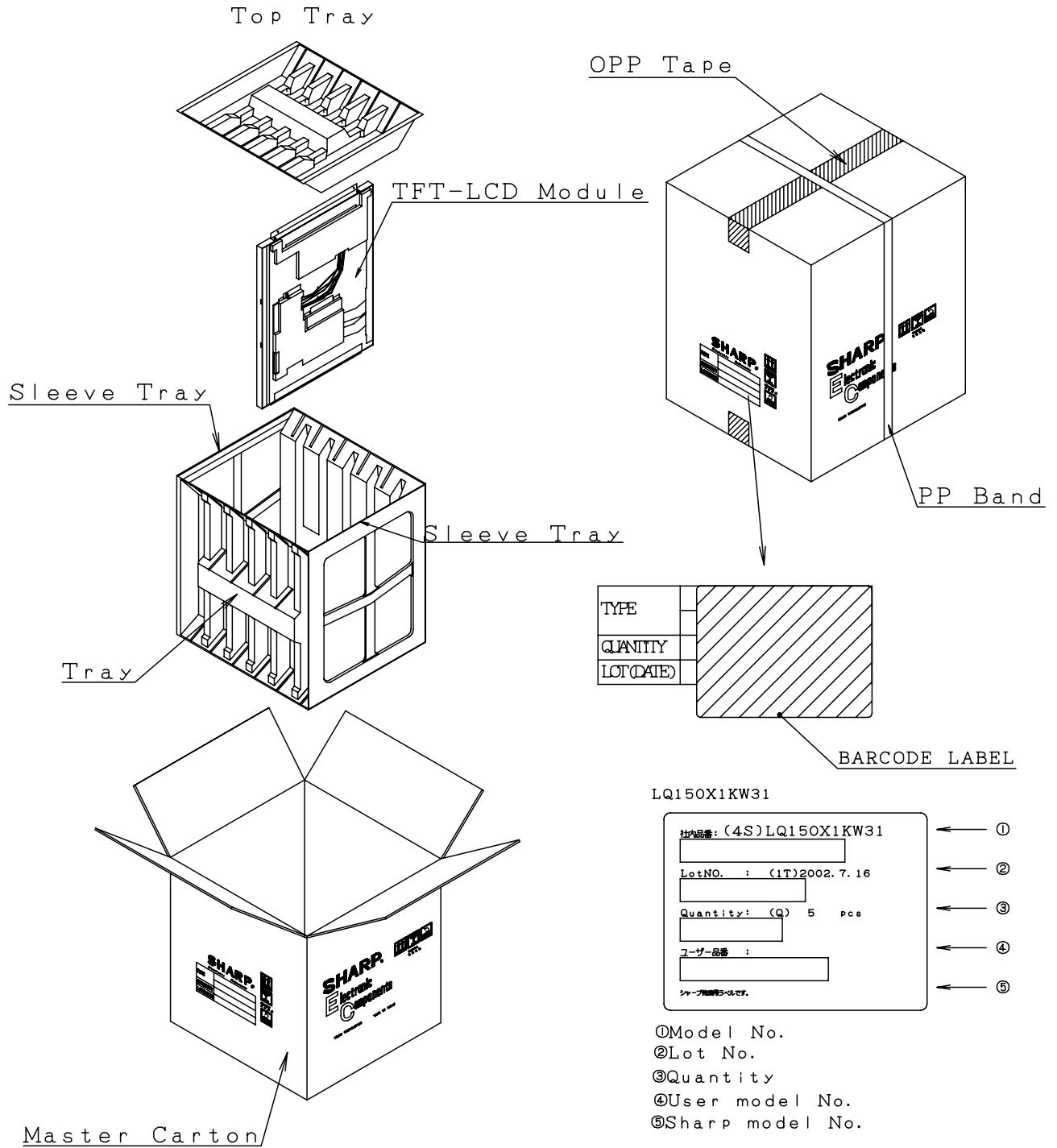

Fig. 6 Packing Form



**SPECIFICATIONS ARE SUBJECT TO CHANGE WITHOUT NOTICE.**

Suggested applications (if any) are for standard use; See Important Restrictions for limitations on special applications. See Limited Warranty for SHARP's product warranty. The Limited Warranty is in lieu, and exclusive of, all other warranties, express or implied. ALL EXPRESS AND IMPLIED WARRANTIES, INCLUDING THE WARRANTIES OF MERCHANTABILITY, FITNESS FOR USE AND FITNESS FOR A PARTICULAR PURPOSE, ARE SPECIFICALLY EXCLUDED. In no event will SHARP be liable, or in any way responsible, for any incidental or consequential economic or property damage.

---

# SHARP®

## **NORTH AMERICA**

---

SHARP Microelectronics of the Americas  
5700 NW Pacific Rim Blvd.  
Camas, WA 98607, U.S.A.  
Phone: (1) 360-834-2500  
Fax: (1) 360-834-8903  
Fast Info: (1) 800-833-9437  
www.sharpsma.com

## **EUROPE**

---

SHARP Microelectronics Europe  
Division of Sharp Electronics (Europe) GmbH  
Sonninstrasse 3  
20097 Hamburg, Germany  
Phone: (49) 40-2376-2286  
Fax: (49) 40-2376-2232  
www.sharpsme.com

## **JAPAN**

---

SHARP Corporation  
Electronic Components & Devices  
22-22 Nagaike-cho, Abeno-Ku  
Osaka 545-8522, Japan  
Phone: (81) 6-6621-1221  
Fax: (81) 6117-725300/6117-725301  
www.sharp-world.com

## **TAIWAN**

---

SHARP Electronic Components  
(Taiwan) Corporation  
8F-A, No. 16, Sec. 4, Nanking E. Rd.  
Taipei, Taiwan, Republic of China  
Phone: (886) 2-2577-7341  
Fax: (886) 2-2577-7326/2-2577-7328

## **SINGAPORE**

---

SHARP Electronics (Singapore) PTE., Ltd.  
438A, Alexandra Road, #05-01/02  
Alexandra Technopark,  
Singapore 119967  
Phone: (65) 271-3566  
Fax: (65) 271-3855

## **KOREA**

---

SHARP Electronic Components  
(Korea) Corporation  
RM 501 Geosung B/D, 541  
Dohwa-dong, Mapo-ku  
Seoul 121-701, Korea  
Phone: (82) 2-711-5813 ~ 8  
Fax: (82) 2-711-5819

## **CHINA**

---

SHARP Microelectronics of China  
(Shanghai) Co., Ltd.  
28 Xin Jin Qiao Road King Tower 16F  
Pudong Shanghai, 201206 P.R. China  
Phone: (86) 21-5854-7710/21-5834-6056  
Fax: (86) 21-5854-4340/21-5834-6057

### **Head Office:**

No. 360, Bashen Road,  
Xin Development Bldg. 22  
Waigaoqiao Free Trade Zone Shanghai  
200131 P.R. China  
Email: smc@china.global.sharp.co.jp

## **HONG KONG**

---

SHARP-ROXY (Hong Kong) Ltd.  
3rd Business Division,  
17/F, Admiralty Centre, Tower 1  
18 Harcourt Road, Hong Kong  
Phone: (852) 28229311  
Fax: (852) 28660779  
www.sharp.com.hk

### **Shenzhen Representative Office:**

Room 13B1, Tower C,  
Electronics Science & Technology Building  
Shen Nan Zhong Road  
Shenzhen, P.R. China  
Phone: (86) 755-3273731  
Fax: (86) 755-3273735