



MODEL NO. : TM047NBH03ISSUED DATE: 2009-12-16VERSION : Ver 2.1

- Preliminary Specification
 Final Product Specification

Customer : _____

Approved by	Notes

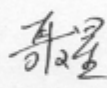
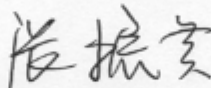
SHANGHAI TIANMA Confirmed :

Prepared by	Checked by	Approved by
 2010.11.23	 2010-01-13	

This technical specification is subjected to change without notice

The information contained herein is the exclusive property of SHANGHAI TIANMA MICRO-ELECTRONICS Corporation, and shall not be distributed, reproduced, or disclosed in whole or in part without prior written permission of SHANGHAI TIANMA MICRO-ELECTRONICS Corporation.



Table of Contents

Coversheet.....	1
Table of Contents.....	2
Record of Revision.....	3
1 General Specifications.....	4
2 Input/Output Terminals.....	5
3 Absolute Maximum Ratings.....	6
4 Electrical Characteristics.....	7
5 Timing Chart.....	9
6 Optical Characteristics.....	14
7 Environmental / Reliability Test.....	18
8 Mechanical Drawing.....	19
9 Packing Drawing.....	20
10 Precautions for Use of LCD Modules.....	21



Record of Revision

Rev	Issued Date	Description	Editor
1.0	2008-11-19	Rev 1.0 was issued	Haijun He
2.0	2009-2-5	Update to final product spec	Haijun He
2.1	2009-12-16	Revise Interface to RGB18 bits with TCON in page4 Update Operating Life Time in page 7 Revise View Angles in page 14 Update Reliability Test Remarks in page 18	Xing Nie

The information contained herein is the exclusive property of SHANGHAI TIANMA MICRO-ELECTRONICS Corporation, and shall not be distributed, reproduced, or disclosed in whole or in part without prior written permission of SHANGHAI TIANMA MICRO-ELECTRONICS Corporation.



1 General Specifications

Feature		Spec
Display Spec.	Size	4.7 inch
	Resolution	480(RGB) x 272
	Interface	RGB 24 bits with TCON
	Color Depth	16.7M
	Technology type	a-Si
	Pixel pitch (mm)	0.216 x 0.216
	Pixel Configuration	R.G.B. Vertical Stripe
	Display Mode	TM with Normally White
	Surface Treatment(Up Polarizer)	Clear type (3H)
	Surface Treatment(TSP)	Anti-glare type (3H)
	Viewing Direction	12 o'clock
	Gray Scale Inversion Direction	6 o'clock
Mechanical Characteristics	LCM (W x H x D) (mm)	114.3x72.5x5.0
	Active Area(mm)	103.680 x 58.752
	With /Without TSP	With TSP
	Weight(g)	76.5
	LED Numbers	10 LEDs

Note 1 : Viewing direction for best image quality is different from TFT definition, there is a 180 degree shift.

Note 2 : Requirements on Environmental Protection: Q/S0002

Note 3: The weight tolerance: $\pm 5\%$



2 Input/Output Terminals

2.1 TFT LCD Panel

Recommended connector: HIROSE FH12A-40S-0.5SH

No	Symbol	I/O	Description	Remark
1	VLED-	P	Power for LED	
2	VLED+	P	Power for LED	
3	GND	P	Power Ground	
4	VDD	P	Power Supply (+3.3V)	
5	R0	I	Red data	
6	R1	I	Red data	
7	R2	I	Red data	
8	R3	I	Red data	
9	R4	I	Red data	
10	R5	I	Red data	
11	R6	I	Red data	
12	R7	I	Red data	
13	G0	I	Green data	
14	G1	I	Green data	
15	G2	I	Green data	
16	G3	I	Green data	
17	G4	I	Green data	
18	G5	I	Green data	
19	G6	I	Green data	
20	G7	I	Green data	
21	B0	I	Blue data	
22	B1	I	Blue data	
23	B2	I	Blue data	
24	B3	I	Blue data	
25	B4	I	Blue data	
26	B5	I	Blue data	
27	B6	I	Blue data	
28	B7	I	Blue data	
29	GND	P	Power Ground	
30	PCLK	I	Pixel clock	
31	DISP	I	Display on/off	
32	HSYNC	I	Horizontal sync signal	
33	VSYNC	I	Vertical sync signal	
34	DE	I	Date enable	
35	NC	-	No connection	
36	GND	P	Power Ground	
37	X1	P	Touch Panel X(Right Side)	
38	Y1	P	Touch Panel Y(6 Clock Side)	
39	X2	P	Touch Panel X(Left Side)	
40	Y2	P	Touch Panel Y(12 Clock Side)	

Note2-1: I/O definition:

I----Input O---Output P----Power/Ground

The information contained herein is the exclusive property of SHANGHAI TIANMA MICRO-ELECTRONICS Corporation, and shall not be distributed, reproduced, or disclosed in whole or in part without prior written permission of SHANGHAI TIANMA MICRO-ELECTRONICS Corporation.



3 Absolute Maximum Ratings

3.1 Driving TFT LCD Panel

Ta = 25°C

Item	Symbol	Min	Max	Unit	Remark
Power Supply Voltage	VDD	-0.3	4.6	V	
Input Signal Voltage	R0-R7,G0-G7,B0-B7,PCLK,DISP, HSYNC, VSYNC, DE	-0.3	VDD +0.3	V	
Back Light Forward Current	I _{LED}	--	25	mA	For each LED
Touch panel pin voltage	X1,X2,Y1,Y2	--	7	V	
Operating Temperature	T _{OPR}	-20	60	°C	
Storage Temperature	T _{STG}	-30	70	°C	



4 Electrical Characteristics

4.1 Driving TFT LCD Panel

GND=0V, Ta=25°C

Item	Symbol	Min	Typ	Max	Unit	Remark	
Power Supply Voltage	VDD	3.0	3.3	3.6	V		
Input Signal Voltage	Low Level	V _{IL}	-0.3	--	0.2xVDD	V	R0-R7,G0-G7,B0-B7 PCLK, DISP, HSYNC, VSYNC, DE
	High Level	V _{IH}	0.8xVDD	--	VDD	V	
Output Signal Voltage	Low Level	V _{OL}	0	--	0.2xVDD	V	
	High Level	V _{OH}	0.8xVDD	--	VDD-	V	
(Panel+ LSI) Power Consumption	Black Mode (60Hz)	--	85	90	mW		
	Standby Mode	--	0.8	1.0	uW		

4.2 Driving Backlight Ta=25°C

Item	Symbol	Min	Typ	Max	Unit	Remark
Forward Current	I _F	--	40	50	mA	5LEDs serial x 2
Forward Voltage	V _F	--	16	--	V	
Power Consumption	W _{BL}	--	640	--	mW	
Operating Life Time	--	10000	(20000)	--	hrs	Note 2

Note 1: The figure below shows the connection of backlight LED.

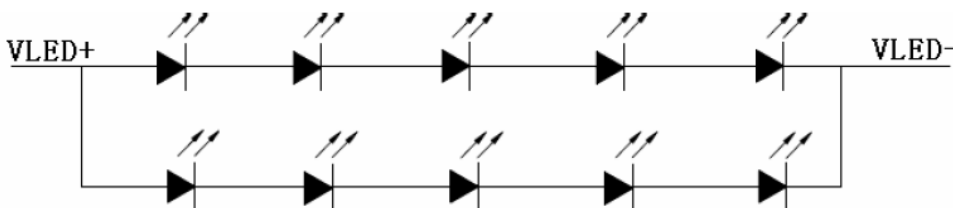

Note 2: I_F is defined for one channel LED.

Optical performance should be evaluated at Ta=25°C only.

If LED is driven by high current, high ambient temperature & humidity condition.

The life time of LED will be reduced.

Operating life means brightness goes down to 50% initial brightness.

Typical operating life time is estimated data.



4.3 Block Diagram

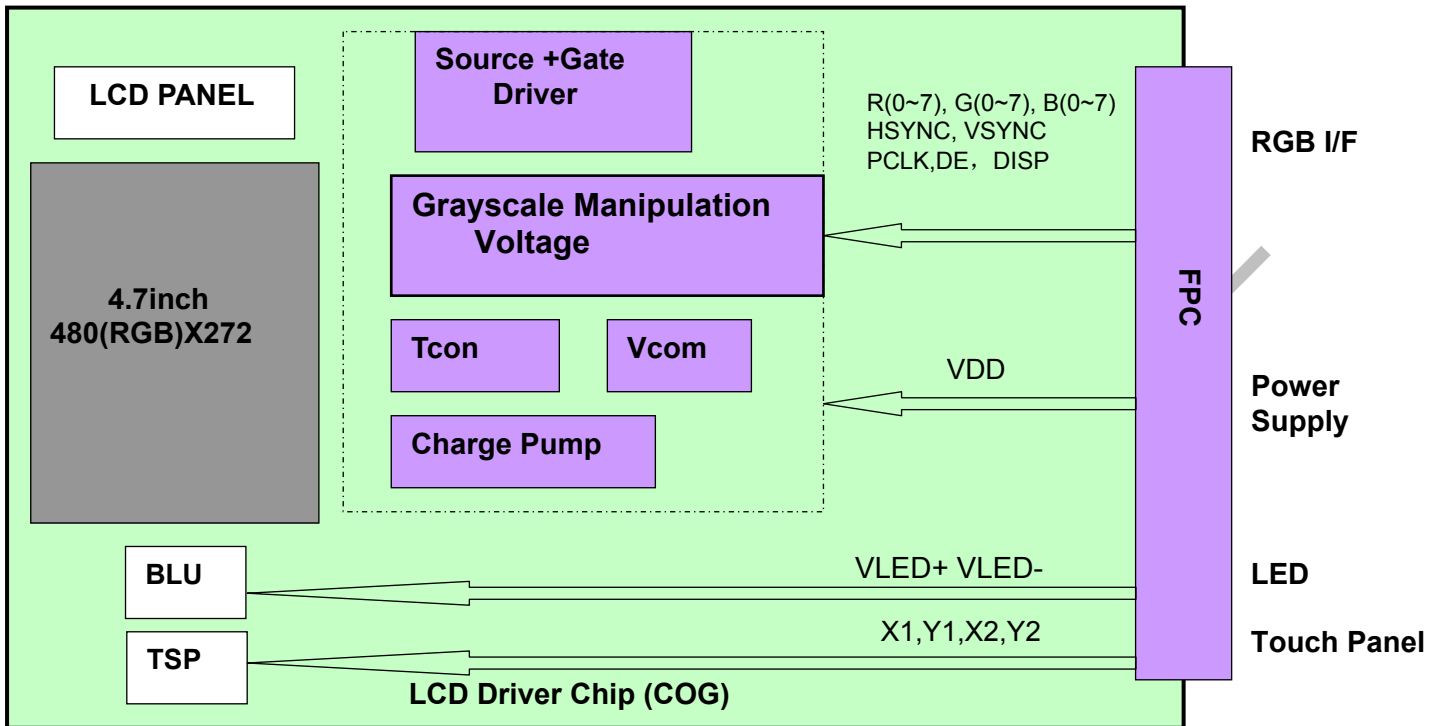



5 Timing Chart

5.1 RGB Timing Parameter

Item	Symbol	Values			Unit	Remark
		Min	Typ	Max		
Clock cycle	1/tc	-	9.00	15	MHz	
Hsync cycle	1/fH	-	17.14	-	KHz	
Vsync cycle	1/fV	-	59.94	-	Hz	
Horizontal signal	Th	525	525	605	CLK	
Horizontal display period	Thd	480	480	480-	CLK	
Horizontal Front porch	Thf	2	2	82	CLK	
Horizontal Pulse width	Thp	2	41	41	CLK	
Horizontal Back porch	Thb	2	2	41	CLK	
Vertical cycle	Tv	285-	286	511	H	
Vertical display period	Tvd	272	272	272	H	
Vertical Front porch	Tvf	1	2	227	H	
Vertical Pulse width	Tvp	1	10	11	H	
Vertical Back porch	Tvb	1	2	11	H	
DISP Setup Time	Tdiss	10	-	-	ns	
DISP Hold Time	Tdish	10	-	-	ns	
Clock Period	PW CLK	66.7	-	-	ns	
Clock Pulse High Period	PWH	26.7	-	-	ns	
Clock Pulse Low Period	PWL	26.7	-	-	ns	
Hsync Setup Time	Ths	10	-	-	ns	
Hsync Hold Time	Thh	10	-	-	ns	
Data Setup Time	Tds	10	-	-	ns	
Data Hold Time	Tdh	10	-	-	ns	
DE Setup Time	Tdes	10	-	-	ns	
DE Hold Time	Tdeh	10	-	-	ns	
Vsync Setup Time	Tvhs	10	-	-	ns	
Vsync Hold Time	Tvhh	10	-	-	ns	

Note 1: Thd=480CLK, Thf= 2CLK, Thp= 41CLK, Thb= 2CLK
525CLK=480CLK + 2CLK + 41CLK + 2CLK

Note 2: Thf+ Thp+ Thb > 44 CLK



5.2 RGB Timing Chart

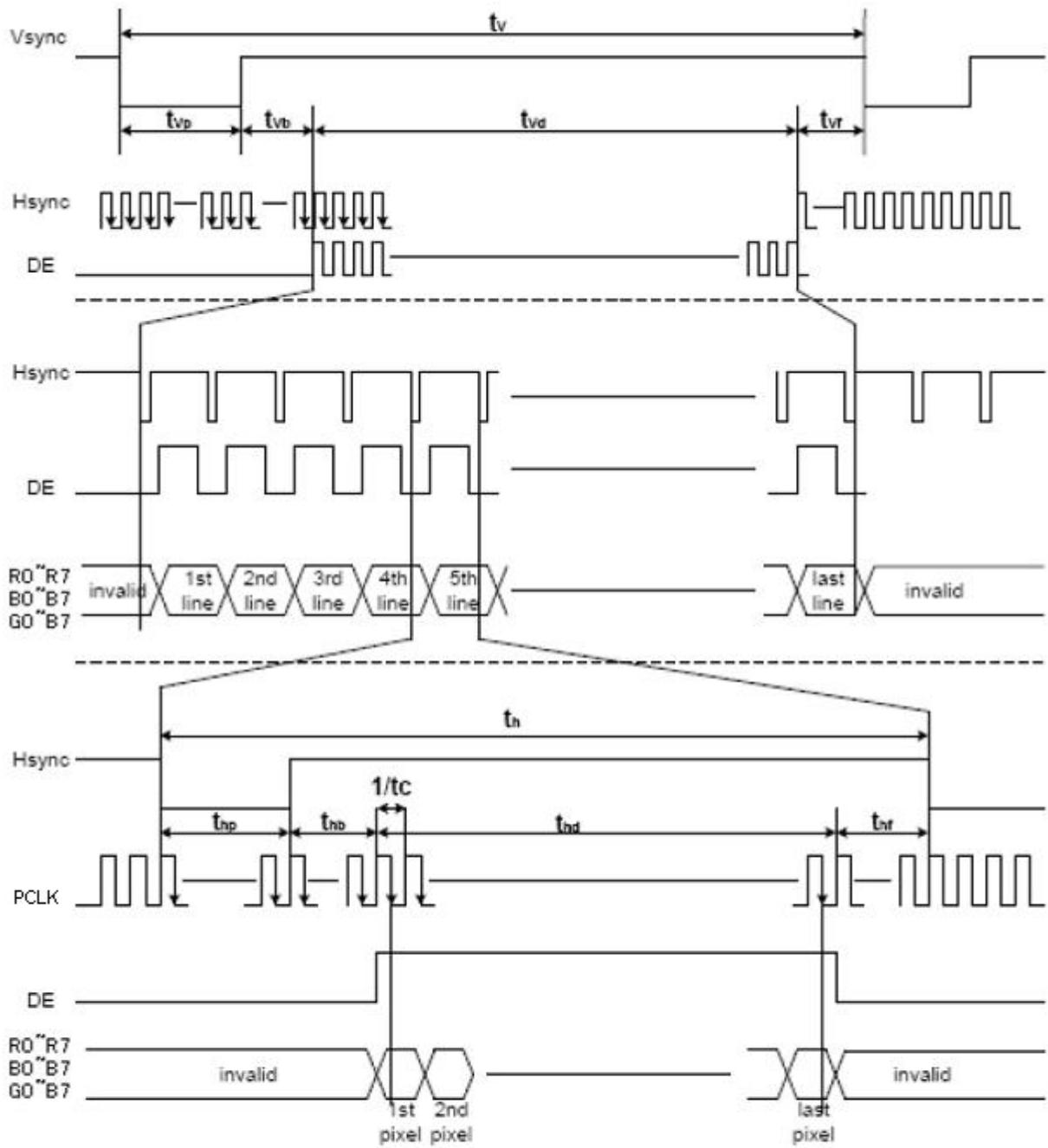

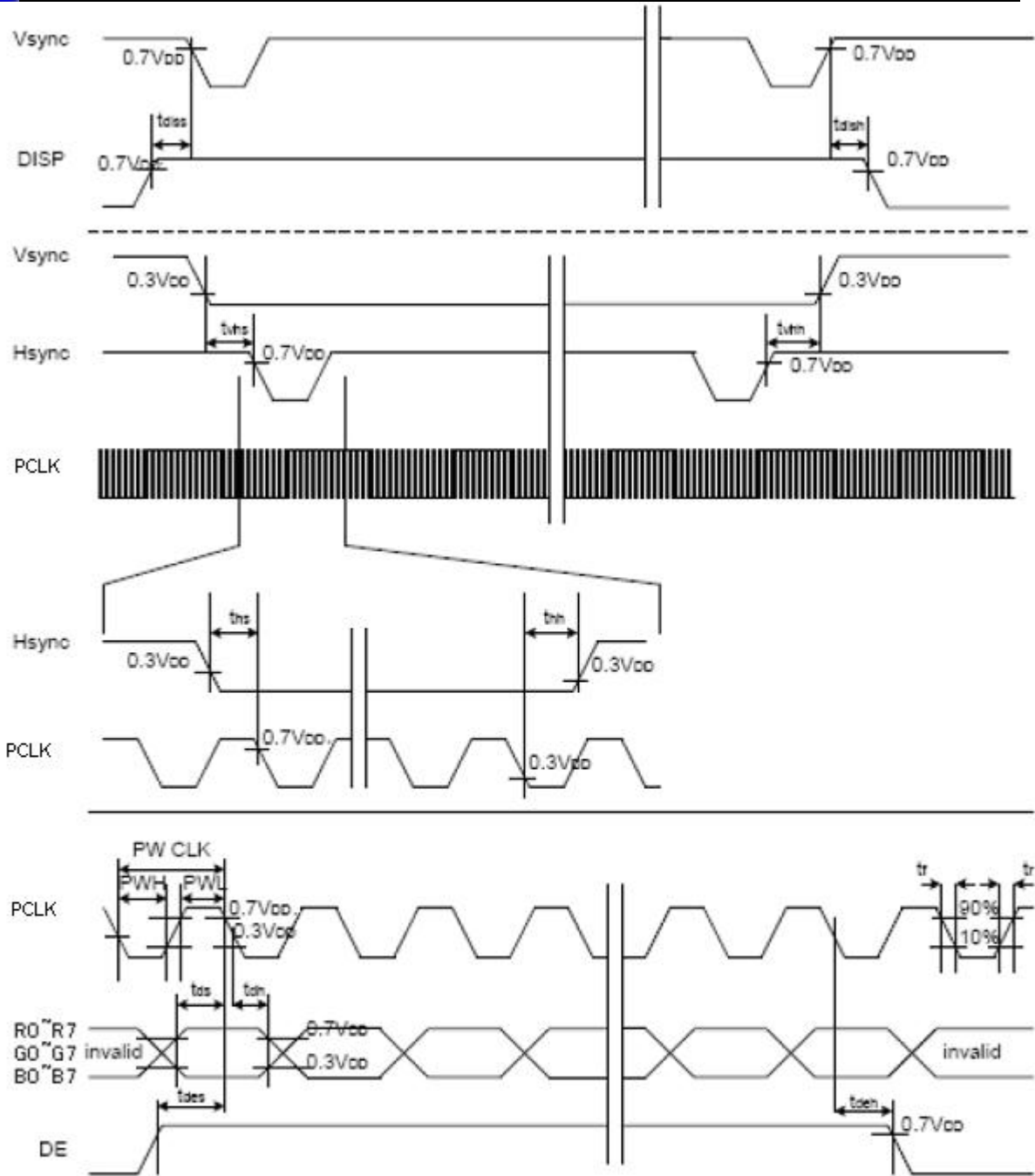



5.3 Power On Sequence

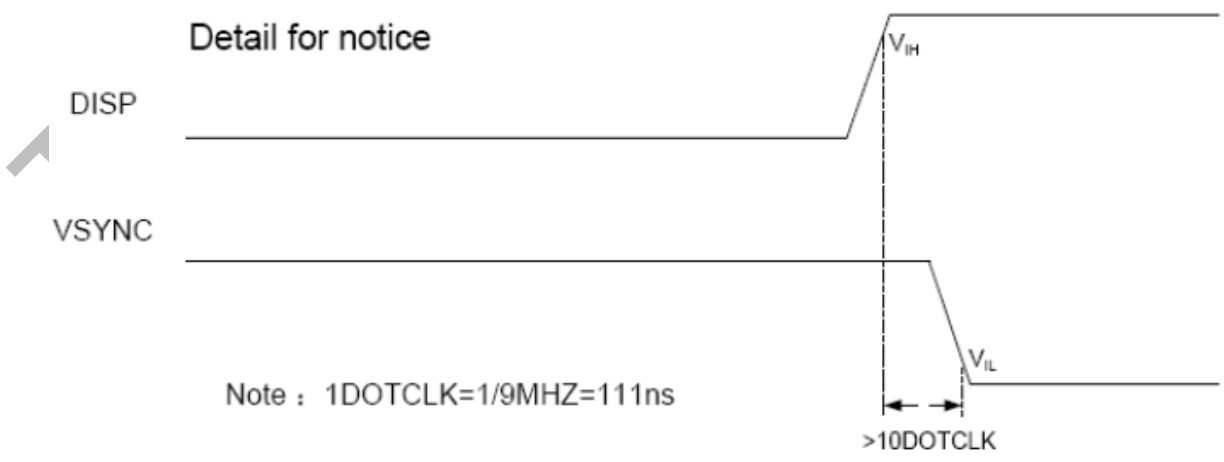
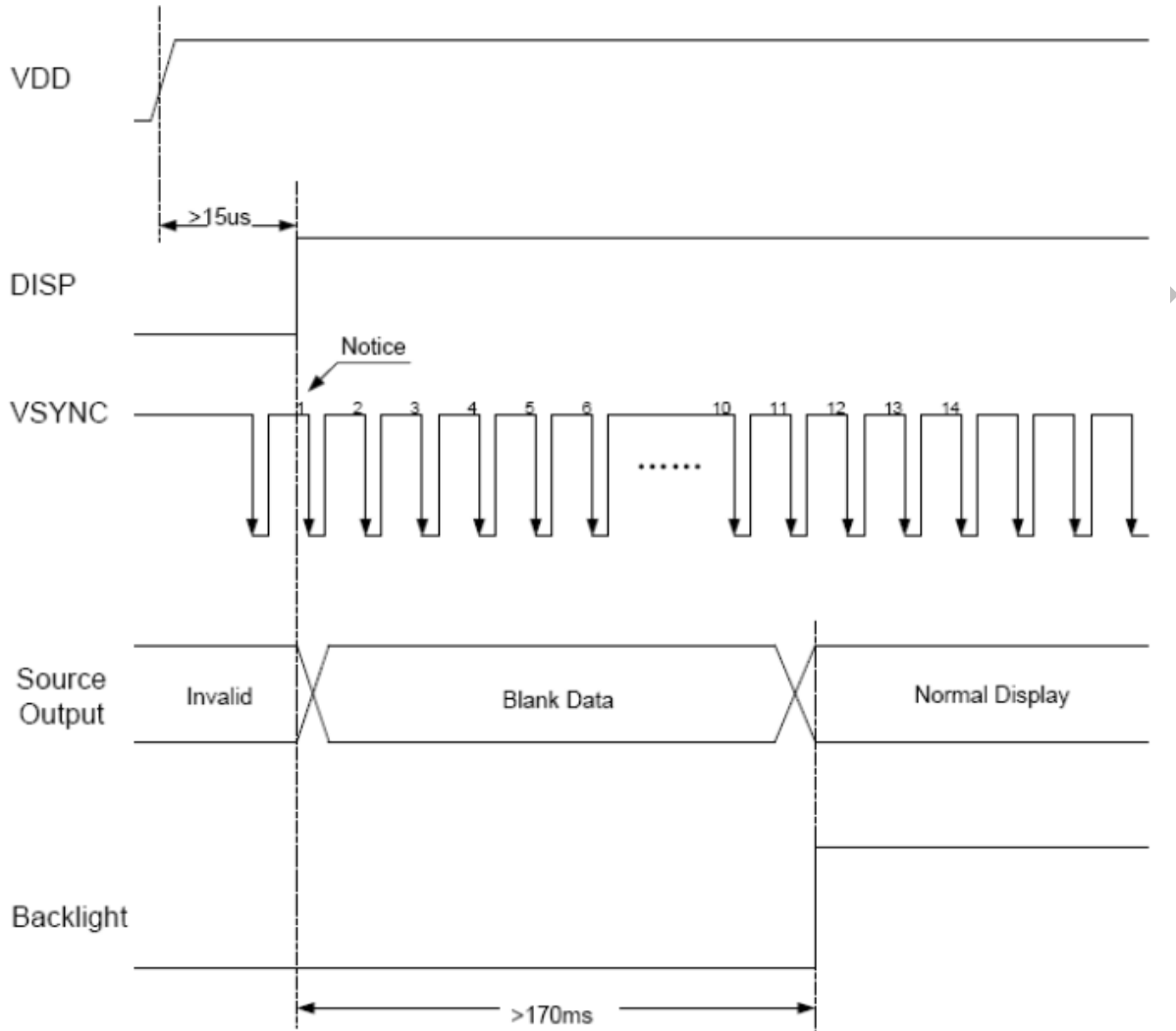

The information contained herein is the exclusive property of SHANGHAI TIANMA MICRO-ELECTRONICS Corporation, and shall not be distributed, reproduced, or disclosed in whole or in part without prior written permission of SHANGHAI TIANMA MICRO-ELECTRONICS Corporation.



5.4 Power Off Sequence

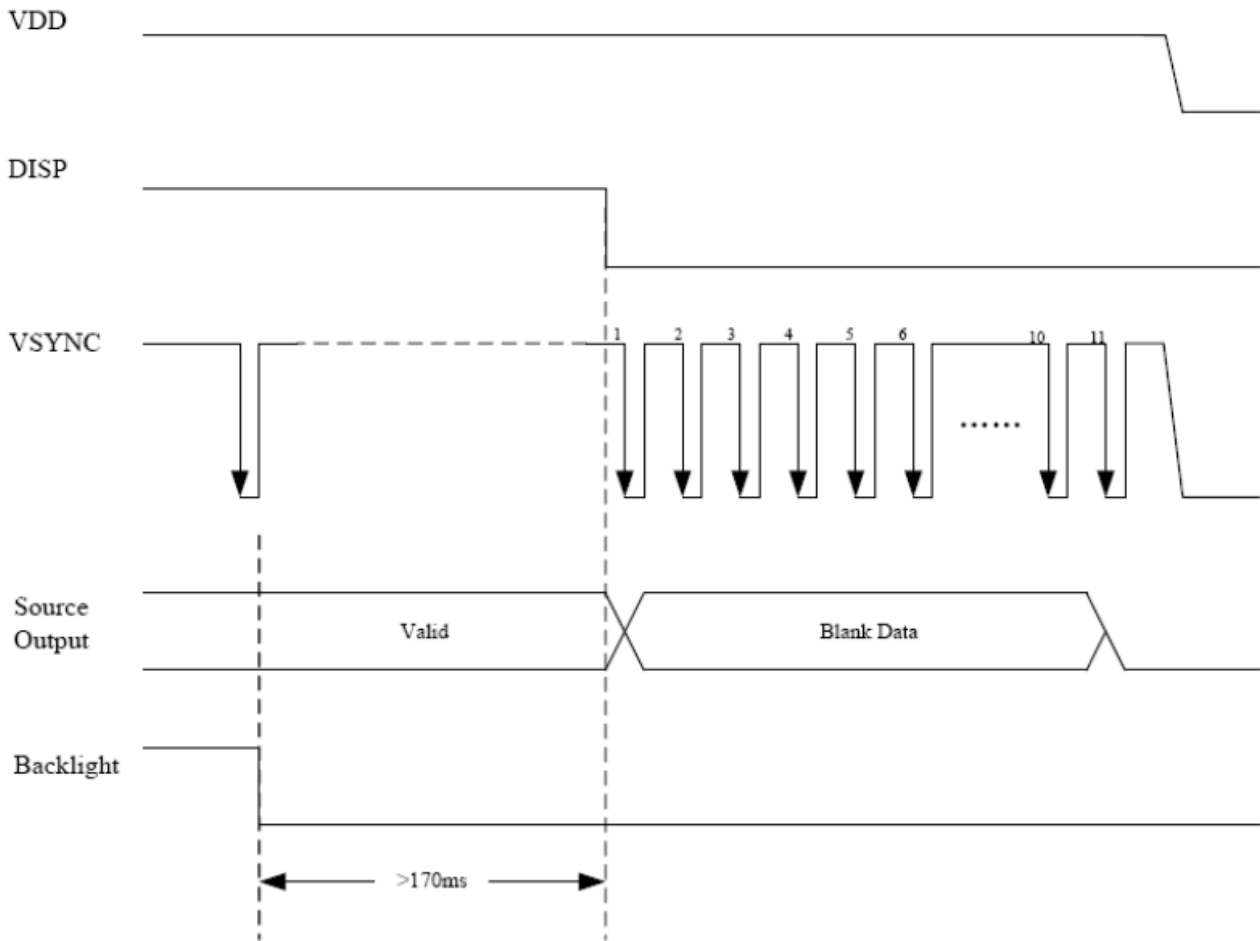

TIANMA



6 Optical Characteristics

6.1 Optical Specification

Ta=25°C

Item	Symbol	Condition	Min	Typ	Max	Unit	Remark	
View Angles	ΘT	CR ≥ 10	50	60	-	Degree	Note 2	
	ΘB		60	70	-			
	ΘL		60	70	-			
	ΘR		60	70	-			
Contrast Ratio	CR	Θ=0°	400	500	-		Note1 Note3	
Response Time	T _{ON}	25°C	-	25	40	ms	Note1 Note4	
	T _{OFF}							
Chromaticity	White	Backlight is on	x	0.260	0.310	0.360		Note5, Note1
			y	0.280	0.330	0.380		
	Red		x	0.530	0.580	0.630		
			y	0.290	0.340	0.390		
	Green		x	0.290	0.340	0.390		
			y	0.530	0.580	0.630		
	Blue		x	0.100	0.150	0.200		
			y	0.040	0.090	0.140		
Uniformity	U		75	80	-	%	Note1 Note6	
NTSC			-	50	-	%	Note 5	
Luminance(with TSP)	L		230	280	-	cd/m ²	Note1 Note7	
Luminance(without TSP)	L		300	350	-	cd/m ²	Note1 Note7	

Test Conditions:

1. VDD=3.3V, I_L=20mA(LED current), the ambient temperature is 25°C.
2. The test systems refer to Note 1 and Note 2.



Note 1: Definition of optical measurement system.

The optical characteristics should be measured in dark room. After 5 minutes operation, the optical properties are measured at the center point of the LCD screen. All input terminals LCD panel must be ground when measuring the center area of the panel.

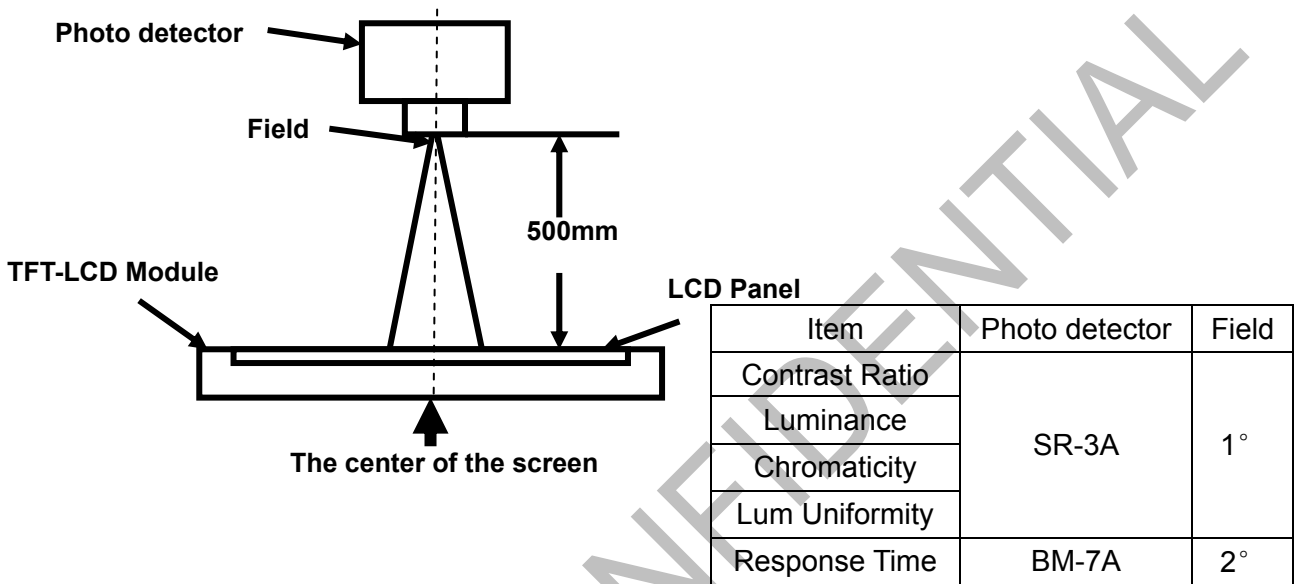

Note 2: Definition of viewing angle range and measurement system.

viewing angle is measured at the center point of the LCD by CONOSCOPE(ergo-80).

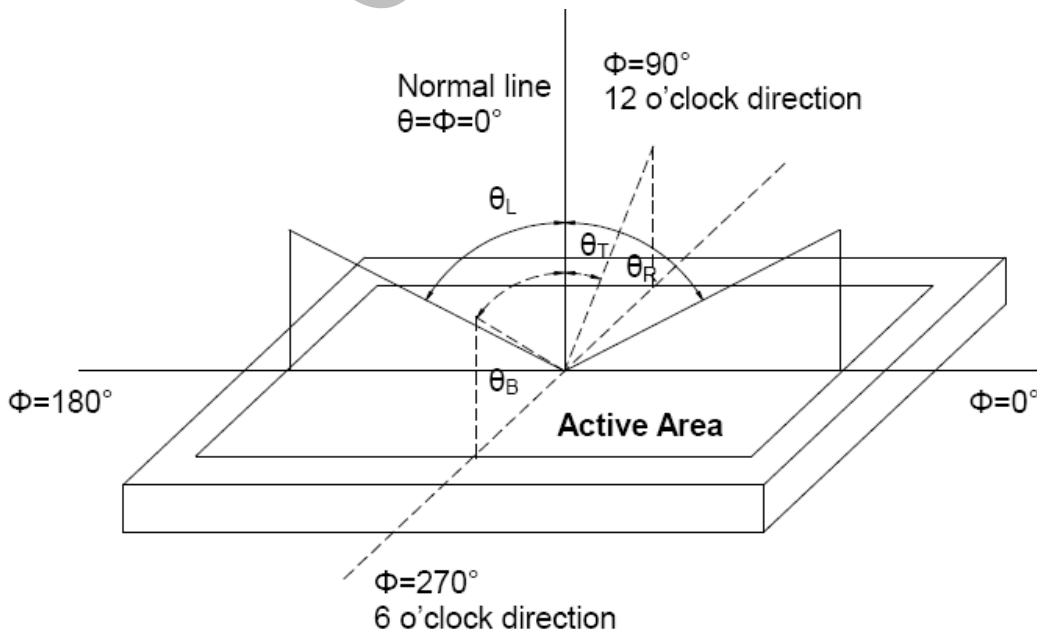

Fig. 1 Definition of viewing angle



Note 3: Definition of contrast ratio

$$\text{Contrast ratio (CR)} = \frac{\text{Luminance measured when LCD is on the "White" state}}{\text{Luminance measured when LCD is on the "Black" state}}$$

"White state": The state is that the LCD should be driven by V_{white} .

"Black state": The state is that the LCD should be driven by V_{black} .

V_{white} : To be determined V_{black} : To be determined.

Note 4: Definition of Response time

The response time is defined as the LCD optical switching time interval between "White" state and "Black" state. Rise time (T_{ON}) is the time between photo detector output intensity changed from 90% to 10%. And fall time (T_{OFF}) is the time between photo detector output intensity changed from 10% to 90%.

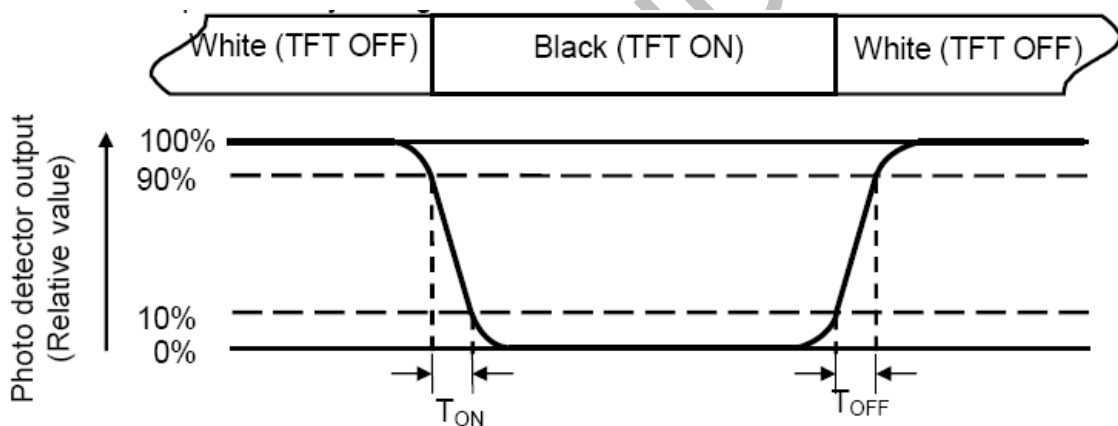

Note 5: Definition of color chromaticity (CIE1931)

Color coordinates measured at center point of LCD.



Note 6: Definition of Luminance Uniformity

Active area is divided into 9 measuring areas (Refer Fig. 2). Every measuring point is placed at the center of each measuring area.

$$\text{Luminance Uniformity}(U) = L_{\min} / L_{\max}$$

L-----Active area length W----- Active area width

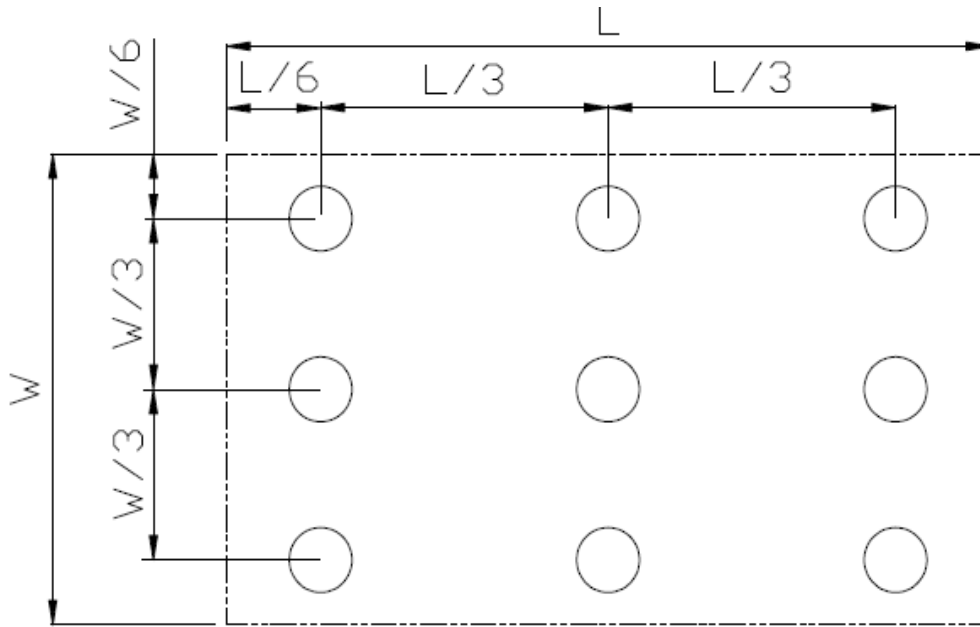

Fig. 2 Definition of uniformity

Lmax: The measured maximum luminance of all measurement position.

Lmin: The measured minimum luminance of all measurement position.

Note 7: Definition of Luminance :

Measure the luminance of white state at center point.



7 Environmental / Reliability Test

No	Test Item	Condition	Remarks
1	High Temperature Operation	Ts=+60°C, 240hrs	Note1 IEC60068-2-2,GB2423.2
2	Low Temperature Operation	Ta=-20°C, 240hrs	IEC60068-2-1 GB2423.1
3	High Temperature Storage	Ta=+70°C, 240hrs	IEC60068-2-1 GB2423.2
4	Low Temperature Storage	Ta=-30°C, 240hrs	IEC60068-2-1 GB2423.1
5	High Temperature & High Humidity Storage	Ta=+60°C, 90% RH 240 hours	Note2 IEC60068-2-78 GB/T2423.3
6	Thermal Shock (Non-operation)	-30°C 30 min~+70°C 30 min, Change time:5min, 20 Cycles	Start with cold temperature, End with high temperature, IEC60068-2-14,GB2423.22
7	Electro Static Discharge (Operation)	C=150pF, R=330Ω, 5points/panel Air:±8KV, 5times; Contact:±4KV, 5 times; (Environment: 15°C~35°C, 30%~60%, 86Kpa~106Kpa)	IEC61000-4-2 GB/T17626.2
8	Vibration (Non-operation)	Frequency range:10~55Hz, Stroke:1.5mm Sweep:10Hz~55Hz~10Hz 2 hours for each direction of X.Y.Z. (6 hours for total)(Package condition)	IEC60068-2-6 GB/T2423.10
9	Package Drop Test	Height:80 cm, 1 corner, 3 edges, 6 surfaces	IEC60068-2-34 GB/T2423.11

Note1: Ts is the temperature of panel's surface.

Note2: Ta is the ambient temperature of sample.



8 Mechanical Drawing

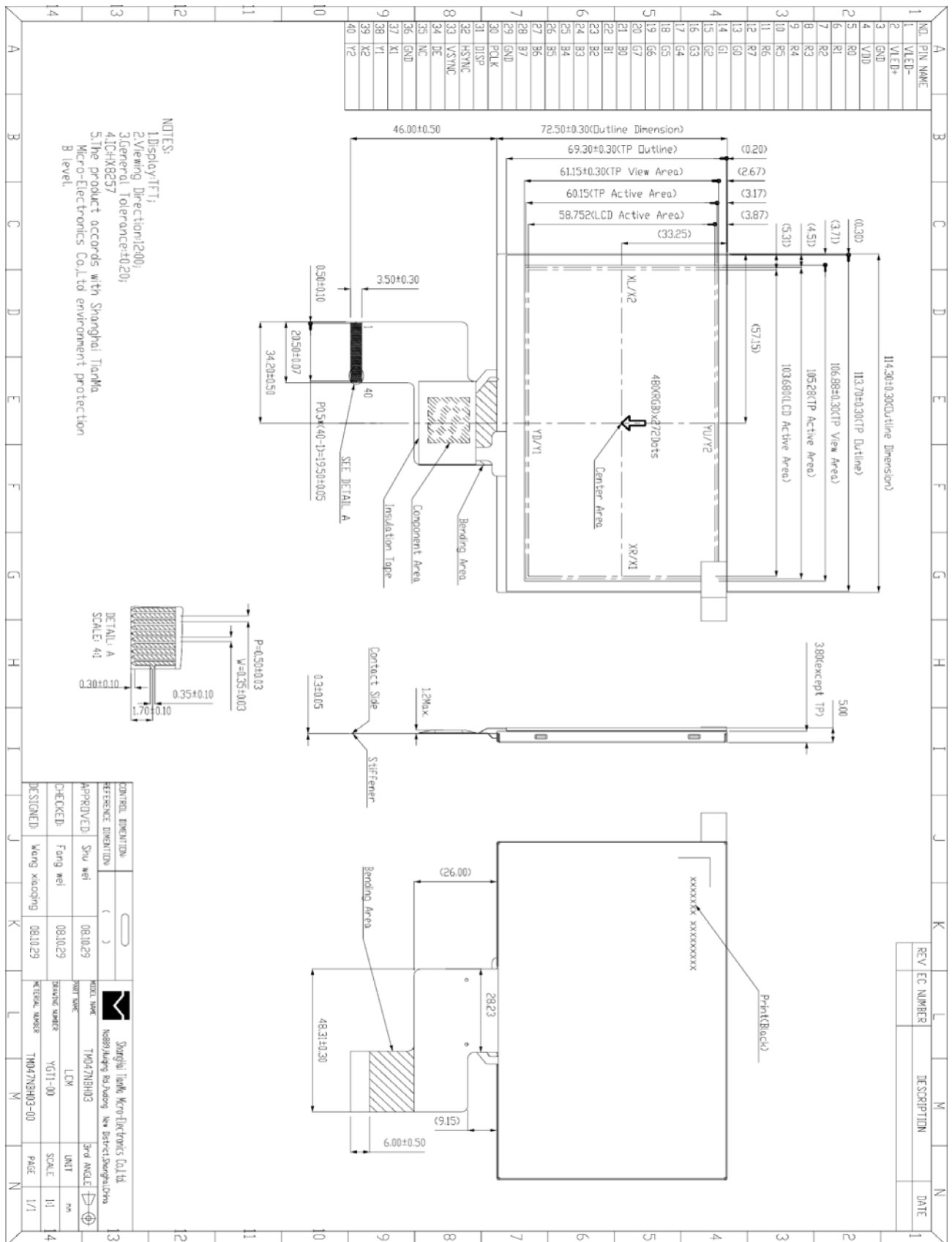

The information contained herein is the exclusive property of SHANGHAI TIANMA MICRO-ELECTRONICS Corporation, and shall not be distributed, reproduced, or disclosed in whole or in part without prior written permission of SHANGHAI TIANMA MICRO-ELECTRONICS Corporation.



9 Packing Drawing

No	Item	Model (Material)	Dimensions (mm)	Unit Weight (Kg)	Quantity	Remark
1	LCM module	TM047NBH03	114.3x72.5x5.0	0.0765	112	
2	Partition_1	Corrugated Paper	513x333x106	0.70000	2	
3.	Anti-Static Bag	PE	175.8x125x0.05	0.0007	112	Anti-static
4	Dust-Proof Bag	PE	-----	0.0600	1	
5	Partition_2	Corrugated Paper	505x332x4.00	0.0900	3	
6	Corrugated Bar	Corrugated paper	513x160x3	0.0400	8	
8	Carton	Corrugated Paper	530x350x250	1.1000	1	
9	Total weight(kg)	Approximately:11.5				

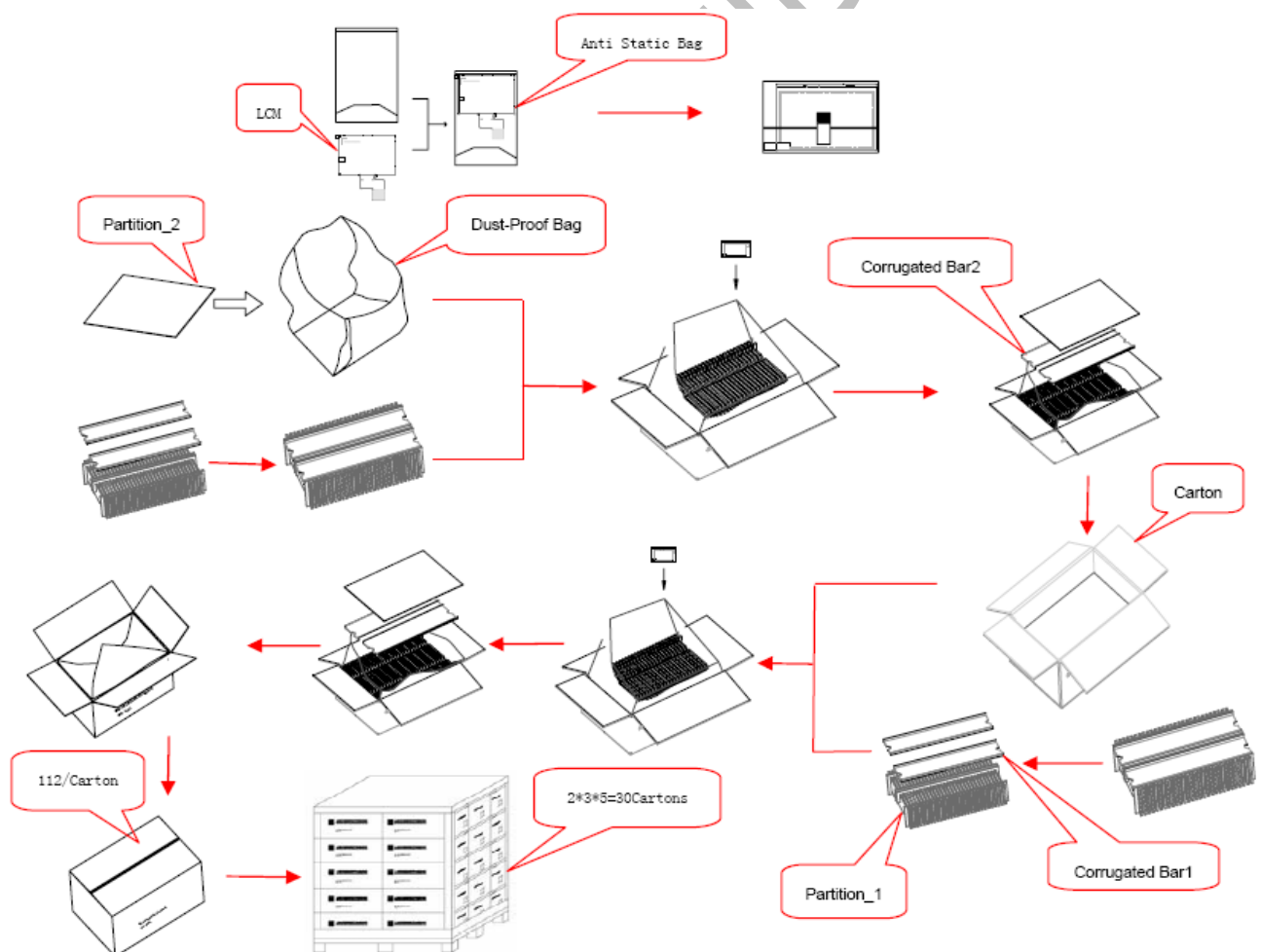

The information contained herein is the exclusive property of SHANGHAI TIANMA MICRO-ELECTRONICS Corporation, and shall not be distributed, reproduced, or disclosed in whole or in part without prior written permission of SHANGHAI TIANMA MICRO-ELECTRONICS Corporation.



10 Precautions for Use of LCD Modules

10.1 Handling Precautions

- 10.1.1 The display panel is made of glass. Do not subject it to a mechanical shock by dropping it from a high place, etc.
- 10.1.2 If the display panel is damaged and the liquid crystal substance inside it leaks out, be sure not to get any in your mouth, if the substance comes into contact with your skin or clothes, promptly wash it off using soap and water.
- 10.1.3 Do not apply excessive force to the display surface or the adjoining areas since this may cause the color tone to vary.
- 10.1.4 The polarizer covering the display surface of the LCD module is soft and easily scratched. Handle this polarizer carefully.
- 10.1.5 If the display surface is contaminated, breathe on the surface and gently wipe it with a soft dry cloth. If still not completely clear, moisten cloth with one of the following solvents:
- Isopropyl alcohol
 - Ethyl alcohol
- Solvents other than those mentioned above may damage the polarizer. Especially, do not use the following:
- Water
 - Ketone
 - Aromatic solvents
- 10.1.6 Do not attempt to disassemble the LCD Module.
- 10.1.7 If the logic circuit power is off, do not apply the input signals.
- 10.1.8 To prevent destruction of the elements by static electricity, be careful to maintain an optimum work environment.
- 10.1.8.1 Be sure to ground the body when handling the LCD Modules.
- 10.1.8.2 Tools required for assembly, such as soldering irons, must be properly ground.
- 10.1.8.3 To reduce the amount of static electricity generated, do not conduct assembly and other work under dry conditions.
- 10.1.8.4 The LCD Module is coated with a film to protect the display surface. Be care when peeling off this protective film since static electricity may be generated.

10.2 Storage precautions

- 10.2.1 When storing the LCD modules, avoid exposure to direct sunlight or to the light of fluorescent lamps.
- 10.2.2 The LCD modules should be stored under the storage temperature range. If the LCD modules will be stored for a long time, the recommend condition is:
- Temperature : 0°C ~ 40°C Relatively humidity: ≤80%
- 10.2.3 The LCD modules should be stored in the room without acid, alkali and harmful gas.

10.3 Transportation Precautions:

The LCD modules should be no falling and violent shocking during transportation, and also should avoid excessive press, water, damp and sunshine.