

Model Name: P320XVF03.0

Issue Date : 2013/05/20

(*) Preliminary Specifications

() Final Specifications

Customer Signature	Date	AUO	Date
Approved By _____		Approval By PM Director <i>Paley Fang</i> _____	
Note		Reviewed By RD Director <i>Eugene Chen</i> _____	
		Reviewed By Project Leader <i>Mingyu Yu</i> _____	
		Prepared By PM <i>Rafael Lu</i> _____	

Contents

No		
		CONTENTS
		RECORD OF REVISIONS
1		GENERAL DESCRIPTION
2		ABSOLUTE MAXIMUM RATINGS
3		ELECTRICAL SPECIFICATION
	3-1	POWER SPECIFICATIONS
	3-2	SIGNAL ELECTRICAL CHARACTERISTICS
	3-3	CONNECTOR
	3-4	HDMI CONNECTOR PIN ASSIGNMENT
	3-5	COLOR INPUT DATA REFERENCE
4		OPTICAL SPECIFICATION
5		MECHANICAL CHARACTERISTICS
6		RELIABILITY TEST ITEMS
7		PACKING
	7-1	DEFINITION OF LABEL
	7-2	PACKING METHODS
	7-3	PALLET AND SHIPMENT INFORMATION
8		PRECAUTION
	8-1	MOUNTING PRECAUTIONS
	8-2	OPERATING PRECAUTIONS
	8-3	ELECTROSTATIC DISCHARGE CONTROL
	8-4	PRECAUTIONS FOR STRONG LIGHT EXPOSURE
	8-5	STORAGE
	8-6	HANDLING PRECAUTIONS FOR PROTECT FILM
9		KEYPAD OPERATION
	9-1	OPERATING PROCEDURE
	9-2	KEYPAD ILLUSTRATION AND FUNCTION
x		

1. General Description

This specification applies to the 32 inch Integrated Transparent LCD Module, P320XVF03.0. This module consists of a TFT LCD panel, a metal frame and a driver board with shield cover. The Module has a TFT active matrix type liquid crystal panel with 1366 x 768 pixels and displays up to 16.7M colors. The P320XVF03.0 has been designed to apply HDMI interface for easy use. It is intended to support applications such as shopping window, exhibition cabinet, vending machine, etc.

* General Information

Items	Specification	Unit	Note
Active Screen Size	31.50	inch	
Display Area	(H) x (V)	mm	
Outline Dimension	745.68 (H) x 485.75(V) x 22(D)	mm	D: T-con cover 8.3mm(without A/D board)
Driver Element	a-Si TFT active matrix		
Display Colors	8 bit, 16.7M	Colors	
Number of Pixels	1,366x768	Pixel	
Pixel Pitch	0.51075 (H) x 0.51075(W)	mm	
Pixel Arrangement	RGB horizontal stripe		
Display Operation Mode	Normally Black		
Surface Treatment	Anti-Glare, 3H		Haze=2%
Rotate Function	Unachievable		Note 1
Display Orientation	Signal input with "ABC"		Note 2

Note 1: Rotate Function refers to LCD display could be able to rotate.

Note 2: LCD display as below illustrated when signal input with "ABC".

Rear side

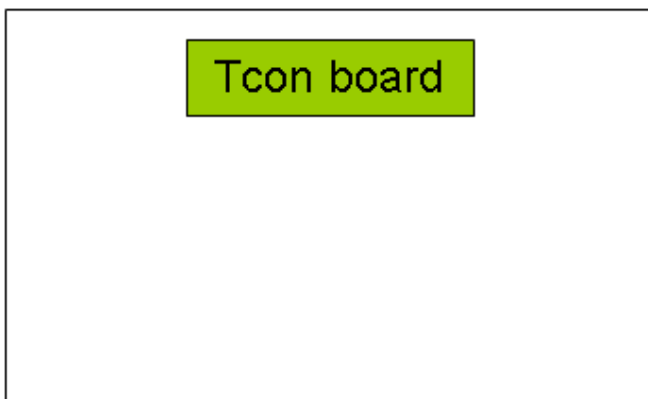

Front side

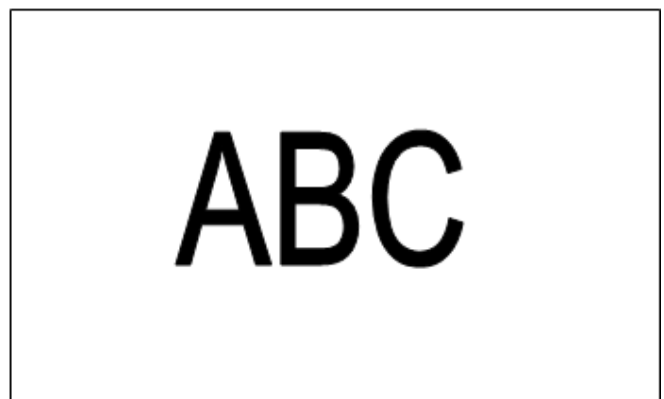

2. Absolute Maximum Ratings

The followings are maximum values which, if exceeded, may cause faulty operation or damage to the unit

Item	Symbol	Min	Max	Unit	Conditions
Logic/LCD Drive Voltage	V_{DD}	-0.3	14	[Volt]	Note 1
Input Voltage of Signal	V_{in}	-0.3	4	[Volt]	Note 1
Operating Temperature	TOP	0	+50	[°C]	Note 2
Operating Humidity	HOP	10	90	[%RH]	Note 2
Storage Temperature	TST	-20	+60	[°C]	Note 2
Storage Humidity	HST	10	90	[%RH]	Note 2
Panel Surface Temperature	PST	-	65	[°C]	Note 3

Note 1: Duration:50 msec.

Note 2 : Maximum Wet-Bulb should be 39°C and No condensation.

The relative humidity must not exceed 90% non-condensing at temperatures of 40°C or less. At temperatures greater than 40°C, the wet bulb temperature must not exceed 39°C.

Note 3: Surface temperature is measured at 50°C Dry condition

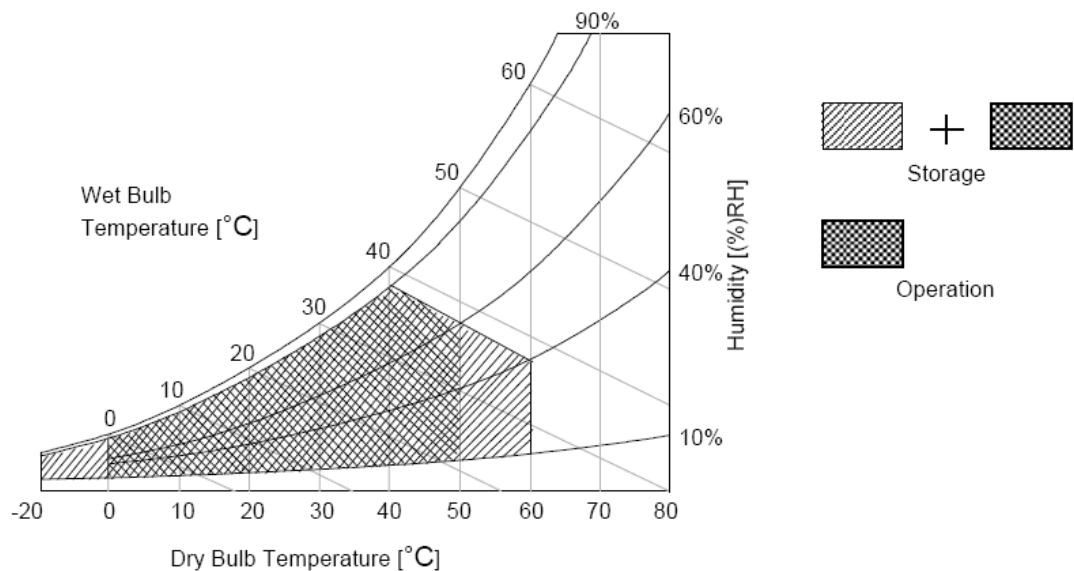

3. Electrical Specification

The P320XVF01.0 requires one power input. It is employed to power the LCD electronics and to drive the TFT array and liquid crystal.

3.1 Power Specifications

Input power specifications are as followings:

Symbol	Parameter	Min	Typ	Max	Unit	Conditions
VDD	LCD Drive Voltage	10.8	12.0	13.2	[Volt]	+/-10%
IDD	Input Current	-	0.55	0.66	[A]	VDD= 12.0V, All white Pattern, At 60Hz
PDD	VDD Power	-	6.6	8.8	[Watt]	VDD= 12.0V, All white Pattern, At 60Hz

3.2 Signal Electrical Characteristics

Input signals shall be HDMI.

It is recommended to refer the specifications of VESA in details.

3.3 Connector

Physical interface is described as follows for the connector on module. These connectors are capable of accommodating the following signals and will be following components.

HDMI Connector	
Manufacturer	SINGATRON or compatible
Type Part Number	2HE.51U1.N08

DC Jack	
Manufacturer	菱揚精密有限公司 or compatible
Type Part Number	HF-DX-00330-AE100ASH1

3.4 HDMI Connector Pin Assignment

PIN #	NAME
1	HDMI2+
2	HDMI_WP
3	HDMI2-
4	HDMI1+
5	GND
6	HDMI1-
7	HDMI0+
8	GND
9	HDMI0-
10	HDMICK+
11	GND
12	HDMICK-
13	NC
14	GND
15	HDMI_SCL
16	HDMI_SDA
17	GND
18	HDMI_5V1
19	HP_DET_HDMI

3.5 Color Input Data Reference

The brightness of each primary color (red, green and blue) is based on the 8 bit gray scale data input for the color; the higher the binary input, the brighter the color. The table below provides a reference for color versus data input.

Color Data Reference

Color		Input Color Data																							
		RED								GREEN								BLUE							
		MSB				LSB				MSB				LSB				MSB				LSB			
		R7	R6	R5	R4	R3	R2	R1	R0	G7	G6	G5	G4	G3	G2	G1	G0	B7	B6	B5	B4	B3	B2	B1	B0
Basic Color	Black	0	0	0	0	0	0	0	0	0	0	0	0	0	0	0	0	0	0	0	0	0	0	0	0
	Red(255)	1	1	1	1	1	1	1	1	0	0	0	0	0	0	0	0	0	0	0	0	0	0	0	0
	Green(255)	0	0	0	0	0	0	0	0	1	1	1	1	1	1	1	1	0	0	0	0	0	0	0	0
	Blue(255)	0	0	0	0	0	0	0	0	0	0	0	0	0	0	0	0	1	1	1	1	1	1	1	1
	Cyan	0	0	0	0	0	0	0	0	1	1	1	1	1	1	1	1	1	1	1	1	1	1	1	1
	Magenta	1	1	1	1	1	1	1	1	0	0	0	0	0	0	0	0	1	1	1	1	1	1	1	1
	Yellow	1	1	1	1	1	1	1	1	1	1	1	1	1	1	1	1	0	0	0	0	0	0	0	0
	White	1	1	1	1	1	1	1	1	1	1	1	1	1	1	1	1	1	1	1	1	1	1	1	1
R	RED(000)	0	0	0	0	0	0	0	0	0	0	0	0	0	0	0	0	0	0	0	0	0	0	0	0
	RED(001)	0	0	0	0	0	0	0	1	0	0	0	0	0	0	0	0	0	0	0	0	0	0	0	0

	RED(254)	1	1	1	1	1	1	1	0	0	0	0	0	0	0	0	0	0	0	0	0	0	0	0	0
	RED(255)	1	1	1	1	1	1	1	1	0	0	0	0	0	0	0	0	0	0	0	0	0	0	0	0
G	GREEN(000)	0	0	0	0	0	0	0	0	0	0	0	0	0	0	0	0	0	0	0	0	0	0	0	0
	GREEN(001)	0	0	0	0	0	0	0	0	0	0	0	0	0	0	1	0	0	0	0	0	0	0	0	0

	GREEN(254)	0	0	0	0	0	0	0	0	1	1	1	1	1	1	1	0	0	0	0	0	0	0	0	0
	GREEN(255)	0	0	0	0	0	0	0	0	1	1	1	1	1	1	1	1	0	0	0	0	0	0	0	0
B	BLUE(000)	0	0	0	0	0	0	0	0	0	0	0	0	0	0	0	0	0	0	0	0	0	0	0	0
	BLUE(001)	0	0	0	0	0	0	0	0	0	0	0	0	0	0	0	0	0	0	0	0	0	0	0	1

	BLUE(254)	0	0	0	0	0	0	0	0	0	0	0	0	0	0	0	0	1	1	1	1	1	1	1	0
	BLUE(255)	0	0	0	0	0	0	0	0	0	0	0	0	0	0	0	0	1	1	1	1	1	1	1	1

4. Optical Specification

Optical characteristics are determined after the unit has been 'ON' and stable for approximately 45 minutes in a dark environment at 25°C. The values specified are at an approximate distance 50cm from the LCD surface at a viewing angle of ϕ and θ equal to 0°.

Fig.1 presents additional information concerning the measurement equipment and method.

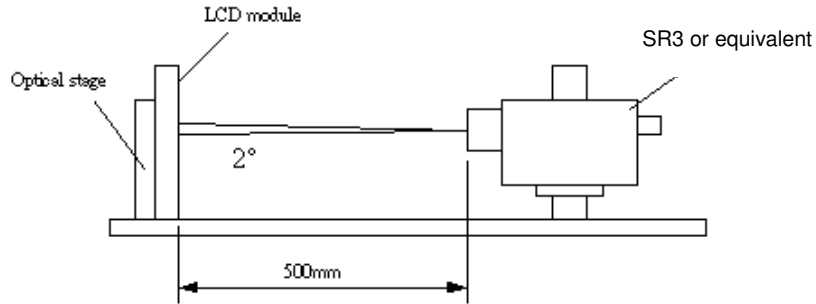

Parameter	Symbol	Condition	Values			Unit	Notes
			Min.	Typ.	Max		
Contrast Ratio	CR	With AUO Module	2400	3000	--		1,2
White Variation	$\delta_{\text{WHITE}(9P)}$		--	--	1.33		1,3
Response Time (G to G)	Tr		--	6.5	--	ms	4
Center Transmittance	T%				6.8	%	1,7
Color Chromaticity		With CS-1000T Standard light source "C"	Typ.-0.03		Typ.+0.03		5
Red	R_x			0.656			
	R_y			0.325			
Green	G_x			0.273			
	G_y			0.591			
Blue	B_x			0.141			
	B_y			0.094			
White	W_x			0.298			
	W_y	0.338					
Viewing Angle		With AUO Module					1,6
x axis, right($\phi=0^\circ$)	θ_r		--	89	--	degree	
x axis, left($\phi=180^\circ$)	θ_l		--	89	--	degree	
y axis, up($\phi=90^\circ$)	θ_u		--	89	--	degree	
y axis, down ($\phi=270^\circ$)	θ_d		--	89	--	degree	

Note:

1. Contrast Ratio (CR) is defined mathematically as:

$$\text{Contrast Ratio} = \frac{\text{Surface Luminance of } L_{on5}}{\text{Surface Luminance of } L_{off5}}$$

2. Surface luminance is luminance value at point 5 across the LCD surface 50cm from the surface with all pixels displaying white. From more information see FIG 2.

3. The variation in surface luminance, δ_{WHITE} is defined (center of Screen) as:

$$\delta_{WHITE(9P)} = \text{Maximum}(L_{on1}, L_{on2}, \dots, L_{on9}) / \text{Minimum}(L_{on1}, L_{on2}, \dots, L_{on9})$$

4. Response time T_{γ} is the average time required for display transition by switching the input signal for five luminance ratio (0%,25%,50%,75%,100% brightness matrix) and is based on $F_v=60\text{Hz}$ to optimize. From more information see FIG 3.

Measured Response Time		Target				
		0%	25%	50%	75%	100%
Start	0%		0% to 25%	0% to 50%	0% to 75%	0% to 100%
	25%	25% to 0%		25% to 50%	25% to 75%	25% to 100%
	50%	50% to 0%	50% to 25%		50% to 75%	50% to 100%
	75%	75% to 0%	75% to 25%	75% to 50%		75% to 100%
	100%	100% to 0%	100% to 25%	100% to 50%	100% to 75%	

5. Viewing angle is the angle at which the contrast ratio is greater than 10. The angles are determined for the horizontal or x axis and the vertical or y axis with respect to the z axis which is normal to the LCD surface. For more information see FIG4.

6. head in 0 degrees vertical angle from mid axis

FIG. 2 Luminance

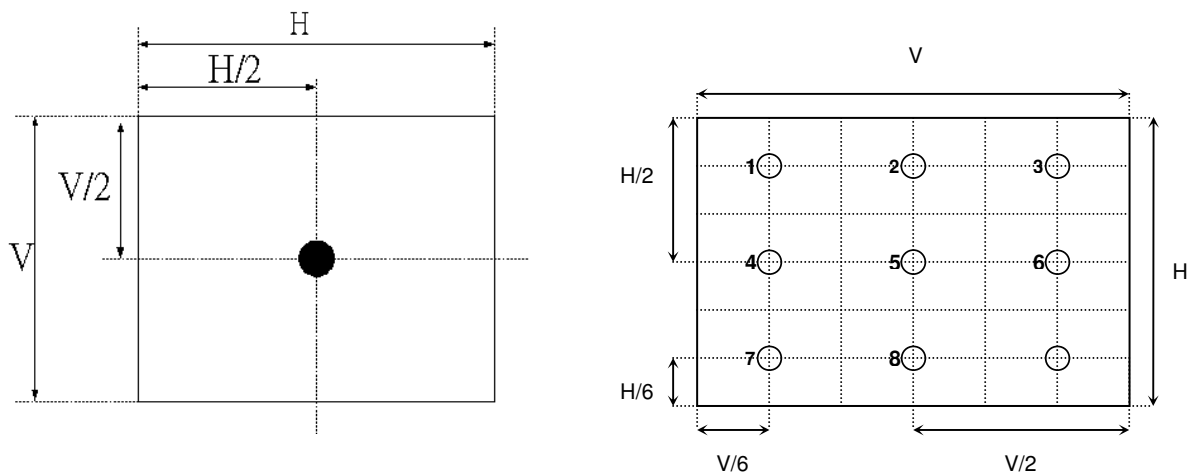

FIG.3 Response Time

The response time is defined as the following figure and shall be measured by switching the input signal for “any level of gray(bright) “ and “any level of gray(dark)”.

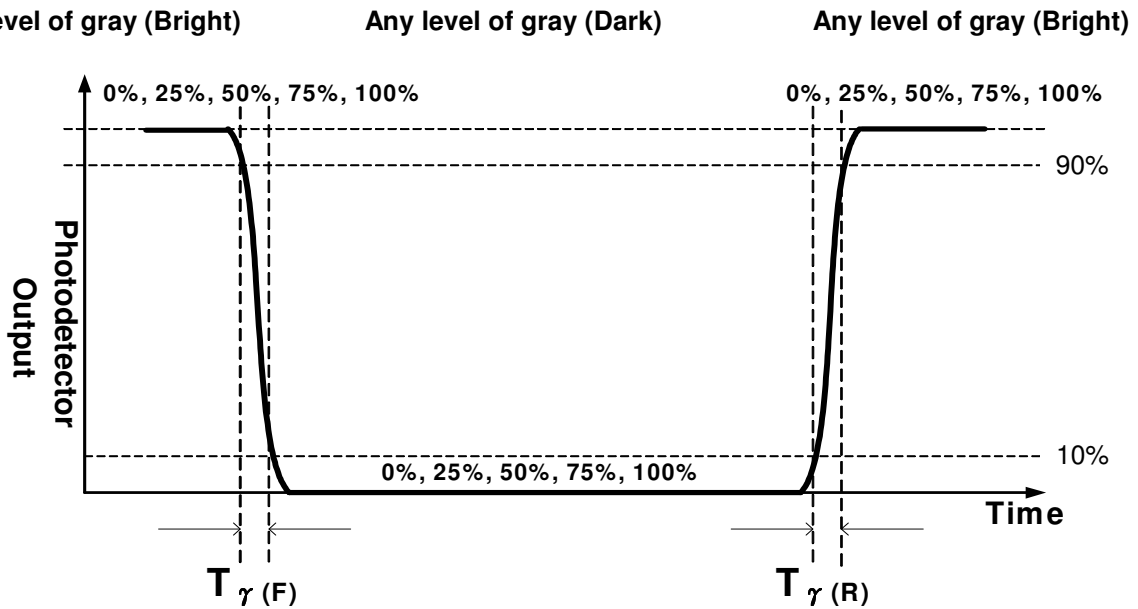
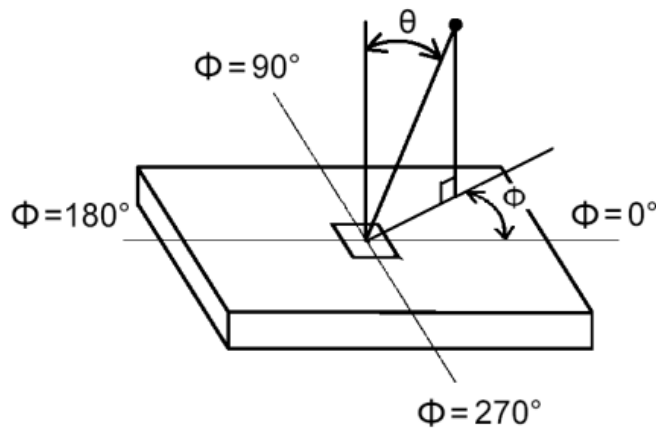

FIG.4 Viewing Angle



5. Mechanical Characteristics

The contents provide general mechanical characteristics for the model P320XVF03.0. In addition the figures in the next page are detailed mechanical drawing of the LCD.

Outline Dimension	Horizontal	745.68mm
	Vertical	485.75mm
	Depth	22mm(T-con cover) 8.3mm(without A/D board)
Bezel Opening	Horizontal	702.68mm
	Vertical	397.25mm
Active Display Area	Horizontal	697.6845mm
	Vertical	392.256mm
Weight	2077g (Typ.)	
Surface Treatment	AG, 3H	

Back View

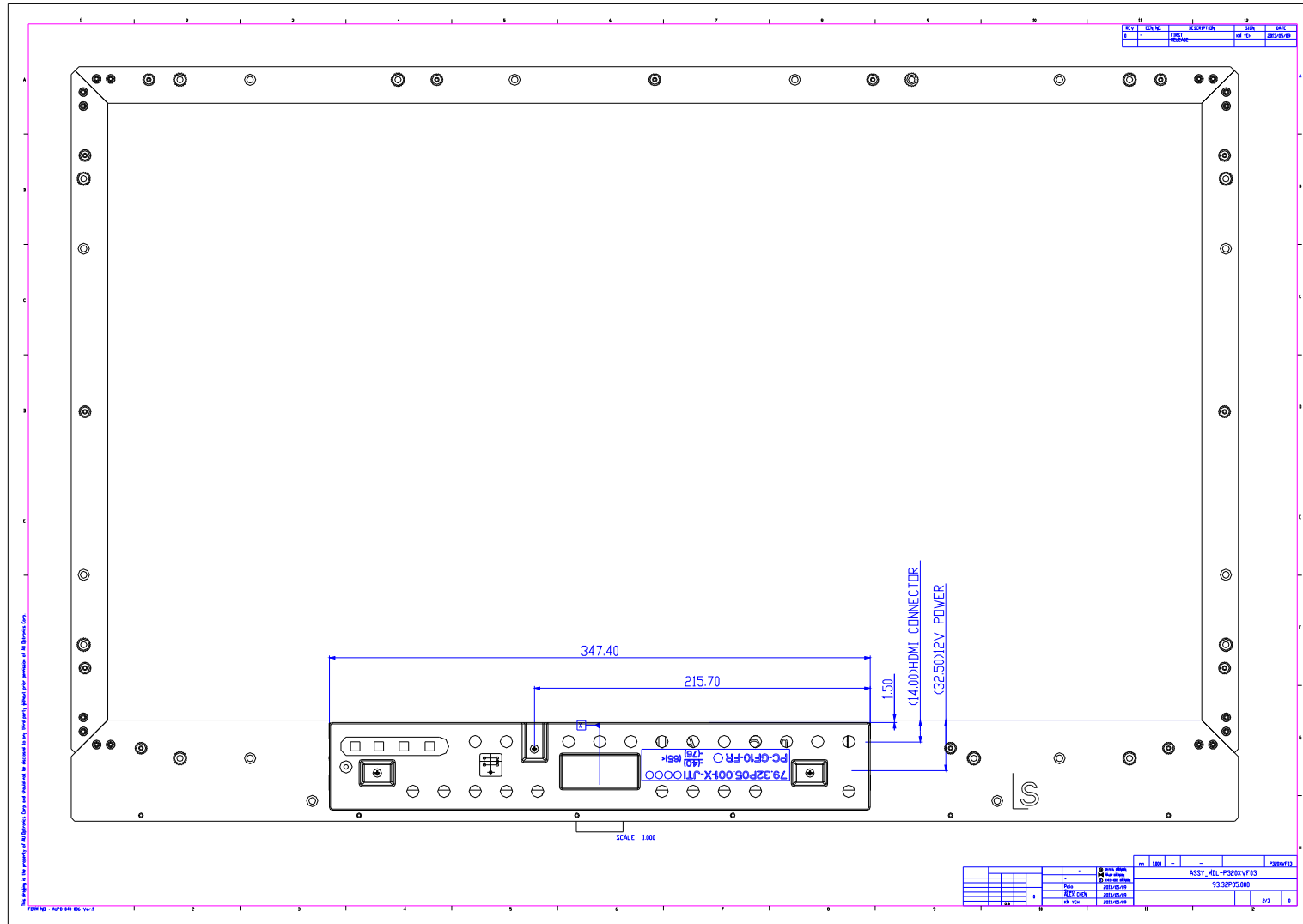

6. Reliability Test Items

	Test Item	Q'ty	Condition
1	High temperature storage test	3	60°C , 300hrs
2	Low temperature storage test	3	-20°C , 300hrs
3	High temperature operation test	3	50°C , 300hrs
4	Low temperature operation test	3	-5°C , 300hrs
5	Vibration test (With carton)	5	Random wave (1.04G RMS, 2-200Hz) 20mins/ Per each X,Y,Z axes
6	Drop test (With carton)	5	Height: 61 cm Direction: 1 corner, 3 edges, 6 flats (ASTMD5276)



7. Packing

7.1 Definition of Label :

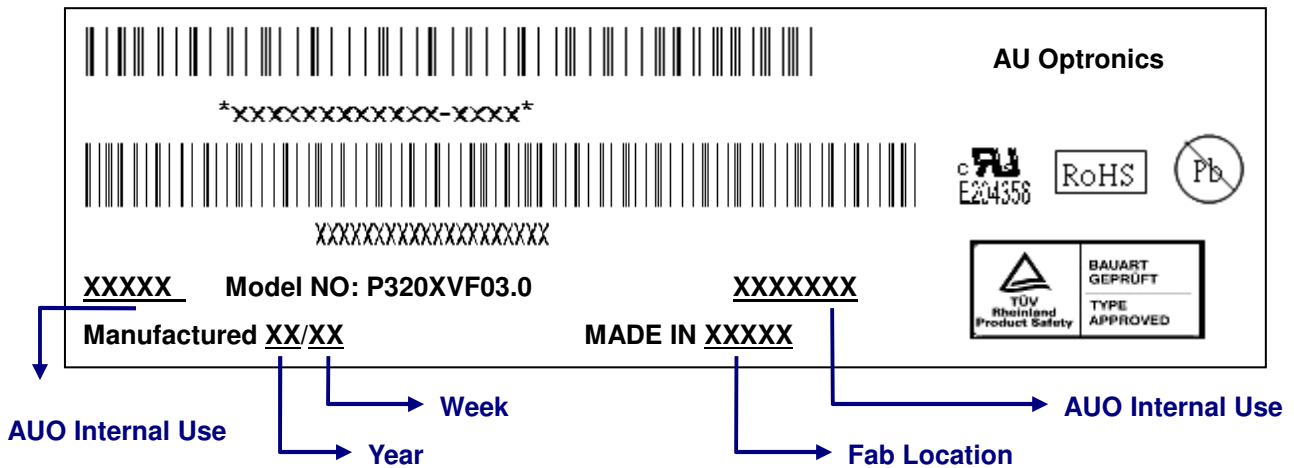
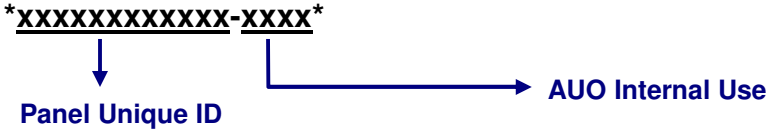
A. Panel Label:



Green mark description

- (1) For Pb Free Product, AUO will add  for identification.
 - (2) For RoHs compatible products, AUO will add  for identification.
- Note: The green Mark will be present only when the green documents have been ready by AUO internal green team. (definition of green design follows the AUO green design checklist.)

B. Carton Label:

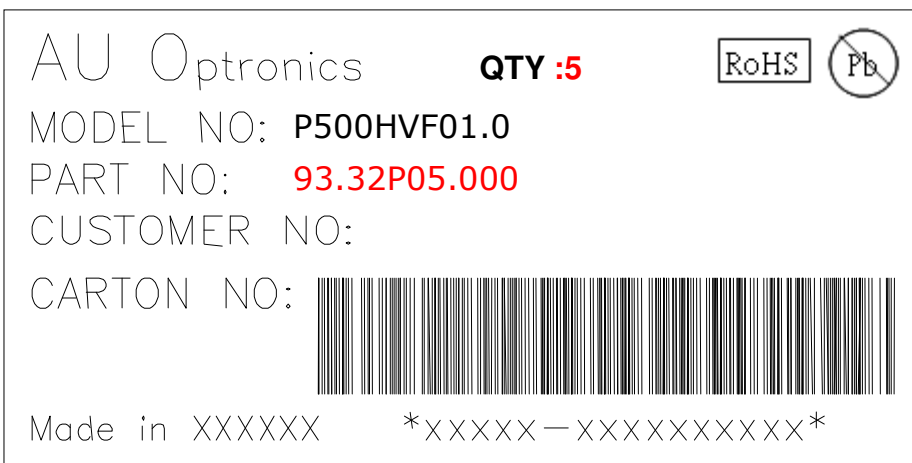

7.2 Packing Methods:

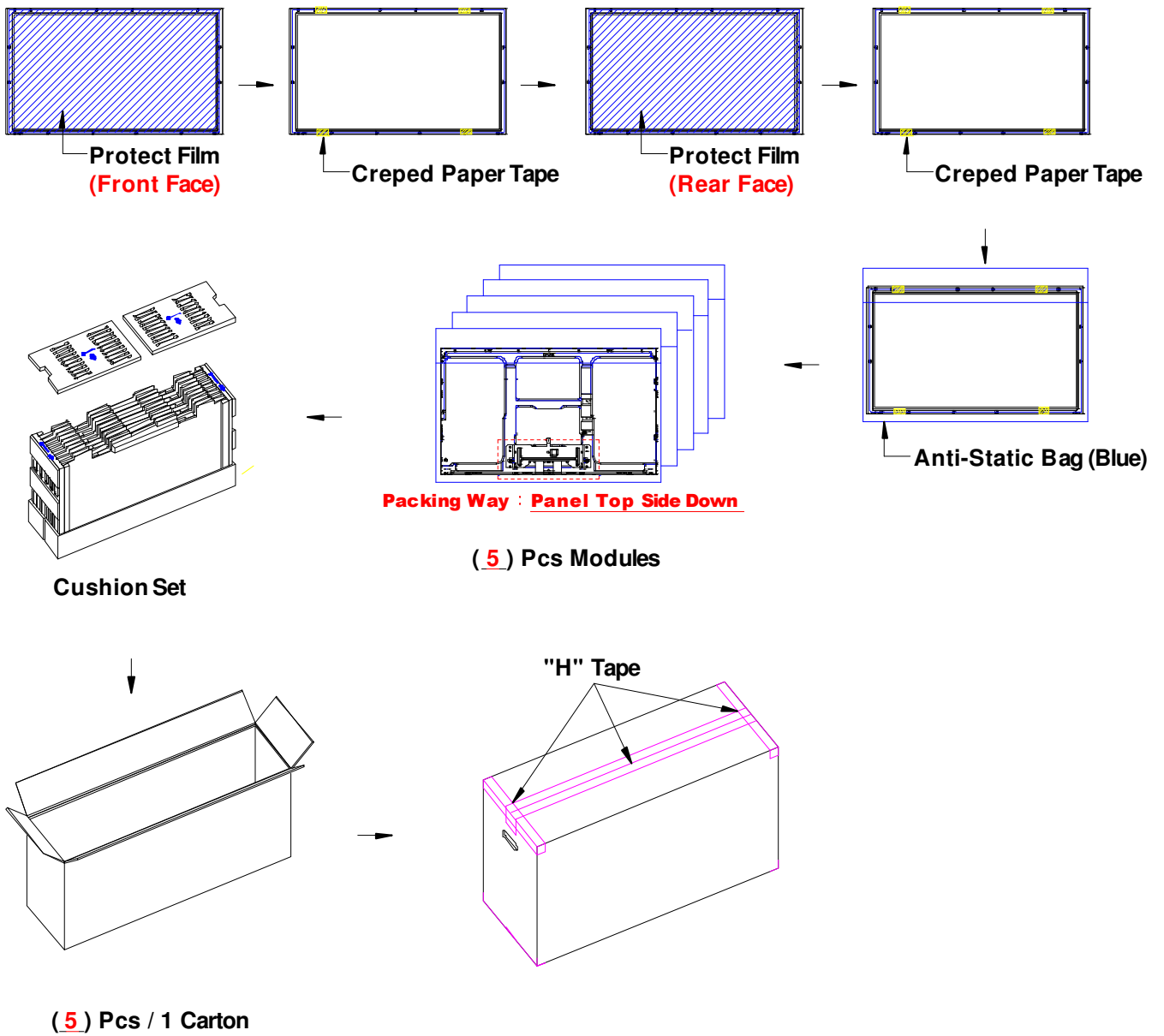

7.3 Pallet and Shipment Information

	Item	Specification			Packing Remark Qty.
		Qty.	Dimension	Weight (kg)	
1	Packing Box	5pcs/1Box	874 x 379 x 596 (mm)	Packing Box	5pcs/1Box
2	Pallet	1	1150 x 840 x 132 (mm)	Pallet	1
3	Boxes per Pallet	6			1150*840*1192 (mm)
4	Panels per Pallet	30			1150*840*1192 (mm)
5	Pallet after packing	6Box/1Pallet	1150*840*1192 (mm)	Pallet after packing	6Box/1Pallet

8. PRECAUTIONS

Please pay attention to the followings when you use this TFT LCD module.

8.1 MOUNTING PRECAUTIONS

- (1) You must mount a module using holes arranged in four corners or four sides.
- (2) You should consider the mounting structure so that uneven force (ex. twisted stress) is not applied to module. And the case on which a module is mounted should have sufficient strength so that external force is not transmitted directly to the module.
- (3) Please attach the surface transparent protective plate to the surface in order to protect the polarizer. Transparent protective plate should have sufficient strength in order to resist external force.
- (4) You should adopt radiation structure to satisfy the temperature specification.
- (5) Acetic acid type and chlorine type materials for the cover case are not desirable because the former generates corrosive gas of attacking the polarizer at high temperature and the latter cause circuit broken by electro-chemical reaction.
- (6) Do not touch, push or rub the exposed polarizer with glass, tweezers or anything harder than HB pencil lead. And please do not rub with dust clothes with chemical treatment. Do not touch the surface of polarizer for bare hand or greasy cloth. (Some cosmetics are detrimental to the polarizer.)
- (7) When the surface becomes dusty, please wipe gently with absorbent cotton or other soft materials like chamois soaks with petroleum benzene. Normal-hexane is recommended for cleaning the adhesives used to attach front/ rear polarizer. Do not use acetone, toluene and alcohol because they cause chemical damage to the polarizer.
- (8) Wipe off saliva or water drops as soon as possible. Their long time contact with polarizer causes deformations and color fading.
- (9) Do not open the case because inside circuits do not have sufficient strength.

8.2 OPERATING PRECAUTIONS

- (1) The device listed in the product specification sheets was designed and manufactured for TV application
- (2) The spike noise causes the mis-operation of circuits. It should be lower than following voltage:
 $V = \pm 200\text{mV}$ (Over and under shoot voltage)
- (3) Response time depends on the temperature. (In lower temperature, it becomes longer..)
- (4) Brightness of LED depends on the temperature. (In lower temperature, it becomes lower.) And in lower temperature, response time (required time that brightness is stable after turned on) becomes longer.
- (5) Be careful for condensation at sudden temperature change. Condensation makes damage to polarizer or electrical contacted parts. And after fading condensation, smear or spot will occur.
- (6) When fixed patterns are displayed for a long time, remnant image is likely to occur.
- (7) Module has high frequency circuits. Sufficient suppression to the electromagnetic interference shall

be done by system manufacturers. Grounding and shielding methods may be important to minimize the interface.

8.3 ELECTROSTATIC DISCHARGE CONTROL

Since a module is composed of electronic circuits, it is not strong to electrostatic discharge. Make certain that treatment persons are connected to ground through wristband etc. And don't touch interface pin directly.

8.4 PRECAUTIONS FOR STRONG LIGHT EXPOSURE

Strong light exposure causes degradation of polarizer and color filter.

8.5 STORAGE

When storing modules as spares for a long time, the following precautions are necessary.

- (1) Store them in a dark place. Do not expose the module to sunlight or fluorescent light. Keep the temperature between 5°C and 35°C at normal humidity.
- (2) The polarizer surface should not come in contact with any other object. It is recommended that they be stored in the container in which they were shipped.

8.6 HANDLING PRECAUTIONS FOR PROTECTION FILM

- (1) The protection film is attached to the bezel with a small masking tape. When the protection film is peeled off, static electricity is generated between the film and polarizer. This should be peeled off slowly and carefully by people who are electrically grounded and with well ion-blown equipment or in such a condition, etc.
- (2) When the module with protection film attached is stored for a long time, sometimes there remains a very small amount of glue still on the bezel after the protection film is peeled off.
- (3) You can remove the glue easily. When the glue remains on the bezel or its vestige is recognized, please wipe them off with absorbent cotton waste or other soft material like chamois soaked with normal-hexane.

9. Keypad Operation

The Integrated Transparent LCD Module allows the users to adjust the transmittance (Tr) of the middle grey level. The operation is based on that the signal input (HDMI) is working.

9-1 Keypad Illustration and Function

- (a) Menu: Pop up OSD menu or Enter into sub-menu
- (b) +: Indicating the cursor movement or OSD manual selection in incremental values
- (c) Return: Return to OSD menu
- (d) -: Indicating the cursor movement or OSD manual selection in decremental values
- (e) Power: Power on/off the module
- (f) LED indicator:

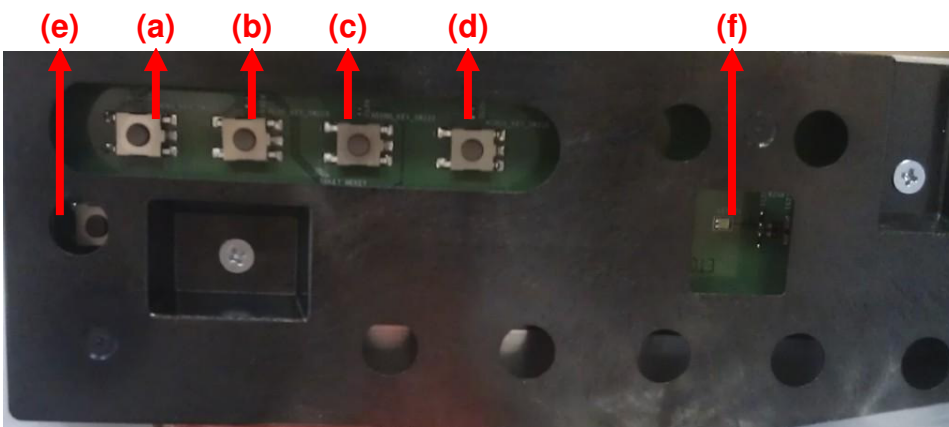

9-2 Operating Procedure

Use the keypads on the control board to adjust the OSD

- (1) Press “(a)” to pop up the OSD menu.
- (2) Press “(a)” to enter the sub-menu.
- (3) Press “(b)” or “(d)” to select items (Tr or Reset*).
- (4) Press “(a)” to the user setting.
- (5) Press “(b)” or “(d)” to adjust.

Note: If Reset is selected, the Tr will be reset to default value.

Structure of OSD Menu

