

SHARP

No.	LD-8258A
DATE	MAY 7. 1996

TECHNICAL LITERATURE
FOR
TFT-LCD module

MODEL No. LQ10'D42

TENTATIVE

The technical literature is subject to change without notice.
So, please contact Sharp or its representative before designing
your product based on this literature.

SHARP CORPORATION
TENRI LIQUID CRYSTAL DISPLAY GROUP
LCD PRODUCTS DEVELOPMENT CENTER

1. Application

This specification applies to color TFT-LCD module, LQ10D42.

These specification sheets are the proprietary product of SHARP CORPORATION ("SHARP") and include materials protected under copyright of SHARP. Do not reproduce or cause any third party to reproduce them in any form or by any means, electronic or mechanical, for any purpose in whole or in part, without the express written permission of SHARP.

The device listed in these specification sheets was designed and manufactured for use in general electronic equipment.

In case of using the device for applications such as control and safety equipment for transportation (aircraft, trains, automobiles, etc.), rescue and security equipment and various safety related equipment which require higher reliability and safety, take into consideration that appropriate measures such as fail-safe functions and redundant system design should be taken.

Do not use the device for equipment that requires an extreme level of reliability, such as aerospace applications, telecommunication equipment (trunk lines), nuclear power control equipment and medical or other equipment for life support.

SHARP assumes no responsibility for any damage resulting from the use of the device which does not comply with the instructions and the precautions specified in these specification sheets.

Contact and consult with a SHARP sales representative for any questions about this device.

2. Overview

This module is a color active matrix LCD module incorporating amorphous silicon TFT (Thin Film Transistor). It is composed of a color TFT-LCD panel, driver ICs, control circuit and power supply circuit and a backlight unit. Graphics and texts can be displayed on a 640X3 X480 dots panel with 262,144 colors by supplying 18 bit data signal (6bit/color), four timing signals, +5V DC supply voltage for TFT-LCD panel driving and supply voltage for backlight.

The TFT-LCD panel used for this module is a low-reflection and higher-color-saturation type. Therefore, this module is also suitable for the multimedia use.

This module is the type of wide viewing angle and high brightness (300cd/m²).

Backlight-driving DC/AC inverter is not built in this module.

3. Mechanical Specifications

Parameter	Specifications	Unit
Display size	26 (10.4") Diagonal	cm
Active area	211.2(H) X158,4(V)	mm
Pixel format	640(H) X 480(V)	pixel
	(1 pixel = R + G + B dots)	
Pixel pitch	0.330(H) X0.330(V)	mm
Pixel configuration	R,G,B vertical stripe	
Display mode	Normally white	
Unit outline dimensions *1	265.0(W) X195.0(H) X11.0(D)	mm
Mass	TBD	g
Surface treatment	Anti-glare and hard-coating 2H Haze value =28 %	-

* 1.Note: excluding backlight cables.

Outline dimensions is **shown** in Fig. 1

4. Input Terminals

4-1. TFT-LCD panel driving

CN1 Used connector:DF9BA-31 P- IV (Hirose Electric Co., Ltd.)

CN1 pin arrangement from module surface
(Transparent view)

Corresponding connector: DF9 -31 S-1 V (//)

DF9A-31S-1V (//)

DF9B-31S-1V (//)

DF9M-31S-1V (//)

Pin No.	Symbol	Function	Remark
1	GND	—	—
2	CK	Clock signal for sampling each data signal	
3	Hsync	Horizontal synchronous signal	【Note1】
4	Vsync	Vertical synchronous signal	【Note1】
5	GND	—	
6	KU	RED data signal(LSB)	—
7	R1	RED data signal	
8	R2	RED data signal	—
9	R3	RED data signal	—
10	R4	RED data signal	—
11	R5	RED data signal(MSB)	—
12	GND	—	
13	GO	GREEN data signal(LSB)	—
14	G1	GREEN data signal	—
15	G2	GREEN data signal	—
16	G3	GREEN data signal	—
17	G4	GREEN data signal	—
18	G5	GREEN data signal(MSB)	—
19	GND	—	
20	B0	BLUE data signal(LSB)	—
21	B1	BLUE data signal	—
22	B2	BLUE data signal	—
23	B3	BLUE data signal	—
24	B4	BLUE data signal	—
25	B5	BLUE data signal(MSB)	—
26	GND	—	
27	ENAB	Signal to settle the horizontal display position	【Note2】
28	Vcc	+ 5.0V power supply	—
29	Vcc	+ 5.0V power supply	
30	R/L	Horizontal display mode select signal	【Note3】
31	U/D	Vertical display mode select signal	【Note4】

※The shielding case is connected with GND.

【Note1】 480 line, 400 line or 350 line mode
is selected by the polarity combination
of the both synchronous signals.

Mode	480 lines	400 lines	350 lines
Hsync	negative	negative	positive
Vsync	negative	positive	negative

【Note2】 The horizontal display start timing is settled in accordance with a rising timing of ENAB signal. In case ENAB is fixed "Low", the horizontal start timing is determined as described in 7-2. Don't keep ENAB "High" during operation.

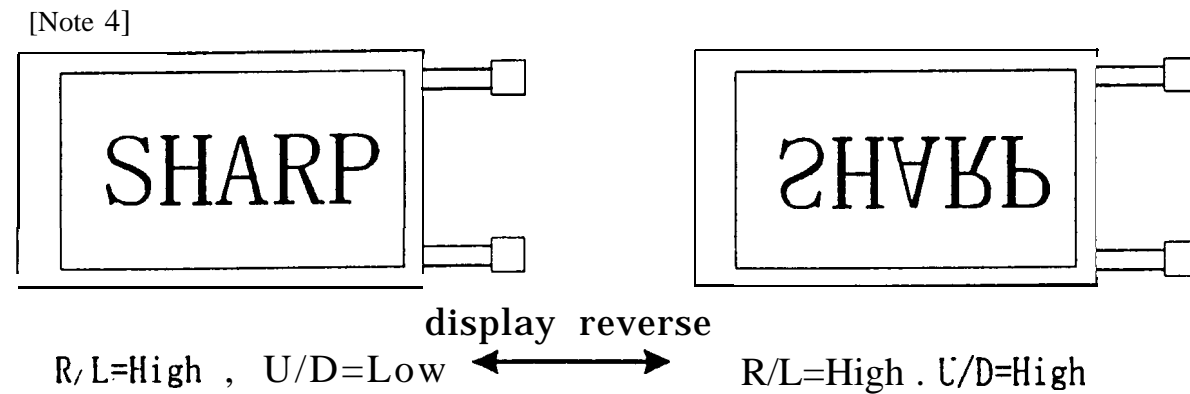
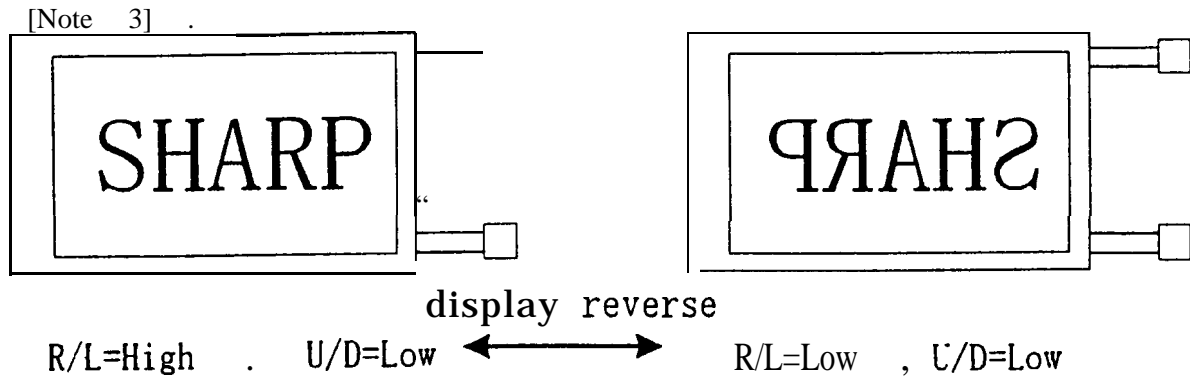

4-2. Backlight driving

Used connector: BHR-03VS-1(JST)

CNA,CNB Corresponding connector :SM02(8.0)B-BHS(JST)

Pin no.	symbol	function
1	V _{HIGH}	Power supply for lamp (High voltage side)
2	NC	This is electrically opened.
3	V _{LOW}	Power supply for lamp (Low voltage side)

5. Absolute Maximum Ratings

Parameter	Symbol	Condition	Ratings	Unit	Remark
Input voltage	V _i	T _a =25°C	-0.3 ~ V _{CC} +0.3	V	[Note1]
+5V supply voltage	V _{CC}	T _a =25°C	0 ~ +6	V	-
Storage temperature	T _{stg}	-	-25 ~ +60	°C	[Note21]
Operating temperature (Ambient)	T _{opa}	-	0- +50	°C	

[Note1] CK,R0~R5,G0~G5,B0~B5,H_{sync},V_{sync},ENAB,R/L,U/D

[Note2] Humidity : 95%RH Max. at T_a ≤ 40°C.

Maximum wet-bulb temperature at 39°C or less at T_a > 40°C.

No condensation.

6. Electrical Characteristics

6-1. TFT-LCD panel driving

Ta=25°C

Parameter		Symbol	Min.	Typ.	Max.	Unit	Remark
+5V	Supply voltage	Vcc	+4.5	+5.0	+5.5	v	【Note1】
	Current dissipation	Icc	-	TBD	TBD	MA	【Note2】
Permissible input ripple voltage		V _{RF}	-	-	100	mVp-p	Vcc=+5V
Input voltage (Low)		V _{IL}	-	-	0.3Vcc	V	【Note3】
Input voltage (High)		V _{IH}	0.7Vcc	-	-	V	
Input current (low)		I _{OL1}	-	-	1.0	μA	V _I =0V 【Note4】
		I _{OL2}	-	-	60.0	μA	V _I =0V 【Note5】
Input current (High)		I _{OH1}	-	-	1.0	μA	V _I =Vcc 【Note6】
		I _{OH2}	-	-	60.0	μA	V _I =Vcc 【Note7】

【Note1】

Vcc-turn-on conditions

- t1 ≤ 10ms
- 0 < t2 ≤ 10ms
- 0 < t3 ≤ 1s

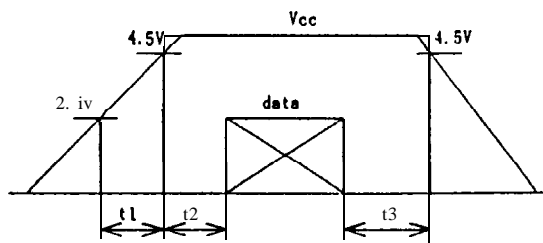

Vcc-dip conditions

- 1) 2.7V ≤ Vcc < 4.5V
td ≤ 10ms
- 2) Vcc < 2.7V

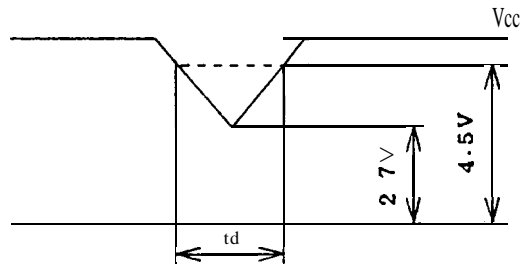

Vcc-dip conditions should also follow the Vcc-turn-on conditions

【Note2】 Typical current situation: 16-gray-bar pattern,
480 line mode

Vcc=+5.0V

【Note3】 CK,R0~R5,G0~G5,B0~B5,Hsync,Vsync,ENAB,R/L,U/D

【Note4】 CK,R0~R5,G0~G5,B0~B5,Hsync,Vsync,ENAB

【Note5】 R/L

【Note6】 CK,R0~R5,G0~G5,B0~B5,Hsync,Vsync

【Note7】 ENAB,U/D

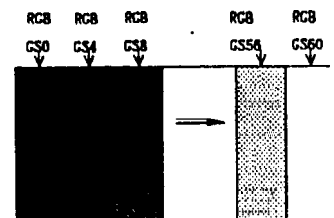

6-2. Backlight driving

The backlight system is an edge-lighting type with double CCFT (Cold Cathode Fluorescent Tube). The characteristics of single lamp are shown in the following table.

$T_a=25^{\circ}\text{C}$

Parameter	Symbol	Min.	Typ.	Max.	Unit	Remark
Lamp current	I_L	2.0	6.0	6.5	mArms	【Note1】
Lamp power consumption	P_L	-	3.0	-	W	【Note2】
Lamp frequency	f_L	20	35	60	KHz	【Note3】
Kick-off voltage	V_s	-	-	950	Vrms	$T_a=25^{\circ}\text{C}$
		-	-	1400	Vrms	$T_a=0^{\circ}\text{C}$ 【Note4】
Lamp life time	L_L	-	(25000)	-	hour	【Note5】

【Note 1】 Lamp current is measured with current meter for high frequency as shown below.

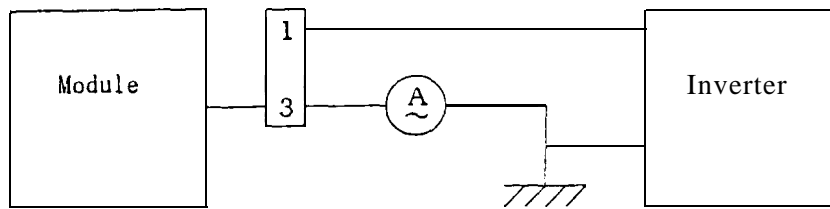

* 3pin is V Low

【Note2】 At the condition of $Y_L = (300) \text{ cd/m}^2$

【Note3】 Lamp frequency may produce interference with horizontal synchronous frequency, and this may cause beat on the display. Therefore lamp frequency shall be detached as much as possible from the horizontal synchronous frequency and from the harmonics of horizontal synchronous to avoid interference.

【Note4】 The open output voltage of the inverter shall be maintained for more than 1sec; otherwise the lamp may not be turned on.

【Note5】 Lamp life time is defined that it applied either ① or ② under this condition
(Continuous turning on at $T_a=25^{\circ}\text{C}$, $I_L=6.5\text{mArms}$)

- ① Brightness becomes 50% of the original value under standard condition.
- ② Kick-off voltage at $T_a=0^{\circ}\text{C}$ exceeds maximum value, 1400 Vrms.

Note) The performance of the backlight, for example life time or brightness, is much influenced by the characteristics of the DC-AC inverter for the lamp. When you design or order the inverter, please make sure that a poor lighting caused by the mismatch of the backlight and the inverter (miss-lighting, flicker, etc.) never occur. when you confirm it, the module should be operated in the same condition as it is installed in your instrument.

7. Timing Characteristics of input signals

Timing diagrams of input signal are shown in Fig.2- 1-3.

1. Timing characteristics

Parameter	Symbol	Mode	Min.	Typ.	Max.	Unit	Remark	
Clock	1/Tc	all	-	25.18	28.33	MHz	-	
	High time	Tch	//	5	-	ns		
	Low time	Tcl	//	10	-	ns		
Data	Setup time	Tds	//	5	-	ns		
	Hold time	Tdh	//	10	-	ns		
Horizontal sync. signal	Cycle	TH	//	30.00	31.78	μs		
		//	750	800	900	clock		
	Pulse width	THp	//	2	96	200	clock	
Vertical sync. signal	Cycle	Tv	480	515	525	560	line	-
			400	446	449	480	line	
			350	447	449	510	line	-
	Pulse width	TVp	all	1	-	34	line	-
Horizontal display period	THd	//	640	640	640	clock	-	
Hsync-Clock phase difference	THc	//	10	-	Tc-10	ns		
Hsync-Vsync phase difference	TVh	//	0	-	TH-THp	clock	-	

Note) In case of **lower frequency**, the deterioration of display **quality**, flicker etc., may be occurred.

7-2. Horizontal display position

The horizontal display position is determined by ENAB signal and the input data corresponding to the rising edge of ENAB signal is displayed at the **left** end of the active area,

Parameter	Symbol	Min.	Typ.	Max.	Unit	Remark	
Enable signal	Se(up time	Tes	5	-	Tc-10	ns	-
	Pulse width	Tcp	2	640	640	clock	-
Hsync-Enable signal phase difference	THE	44	-	164	clock	-	

Note) When ENAB is fixed "**Low**", the display starts from the **data of C104(clock)** as shown in Fig.2- 1-3. Be careful that the module does **not work** when ENAB is fixed "High".

7-3. Vertical display position

The vertical display position is automatically centered in the **active** area at each mode of VGA,480-,400-, and 350-line mode. Each mode is selected depending on the polarity of the **synchronous** signals described in 4-1 (Note 1).

In **each** mode, the data of TVn is displayed at the top line of the active area. And the display position **will** be centered on the screen like the **following** figure **when** the period of vertical synchronous **signal,TV, is typical** value.

In **400-, and 350-line mode, the** data in the vertical data invalid period is also displayed. **So, inputting** all data "O" is **recommended** during vertical data invalid period.

ENAB **signal** has no relation to the vertical display position.

mode	V-data start(TVs)	V-data period(TVd)	V-display start(TVn)	V-display period	Unit	Remark
480	34	480	34	480	line	-
400	34	400	443-TV	480	line	-
350	61	350	445-TV	480	line	-

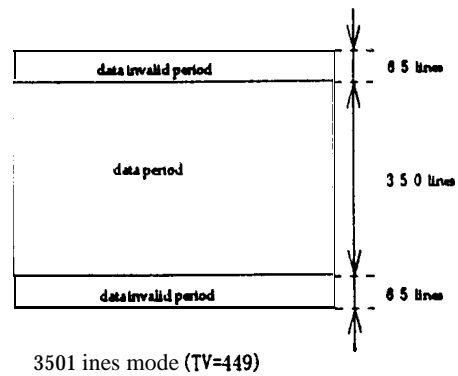
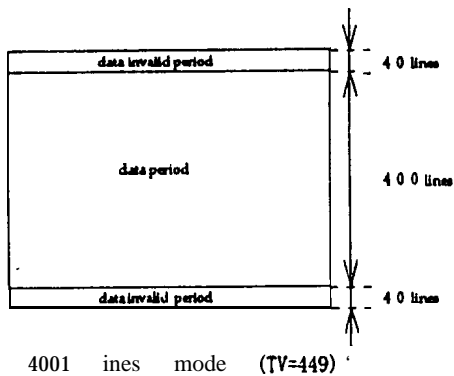

7-4. Input Data Signals and Display Position on the screen

Display position of input data (480 lines mode)

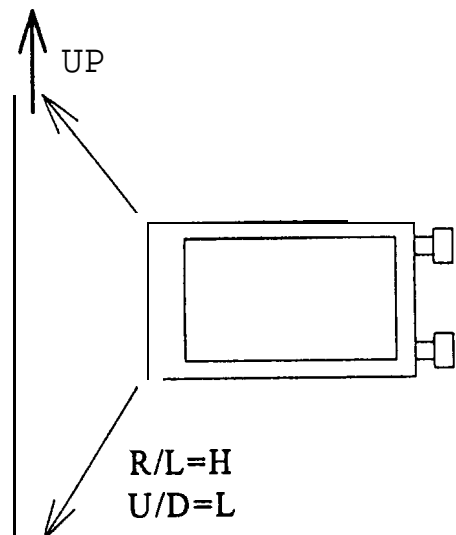
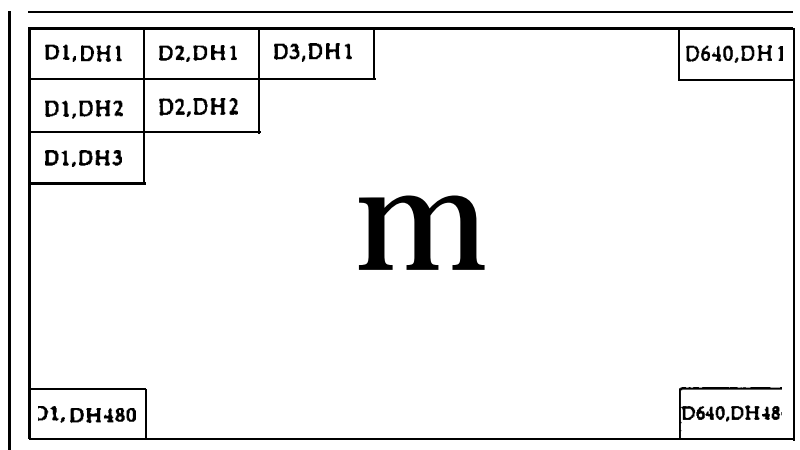

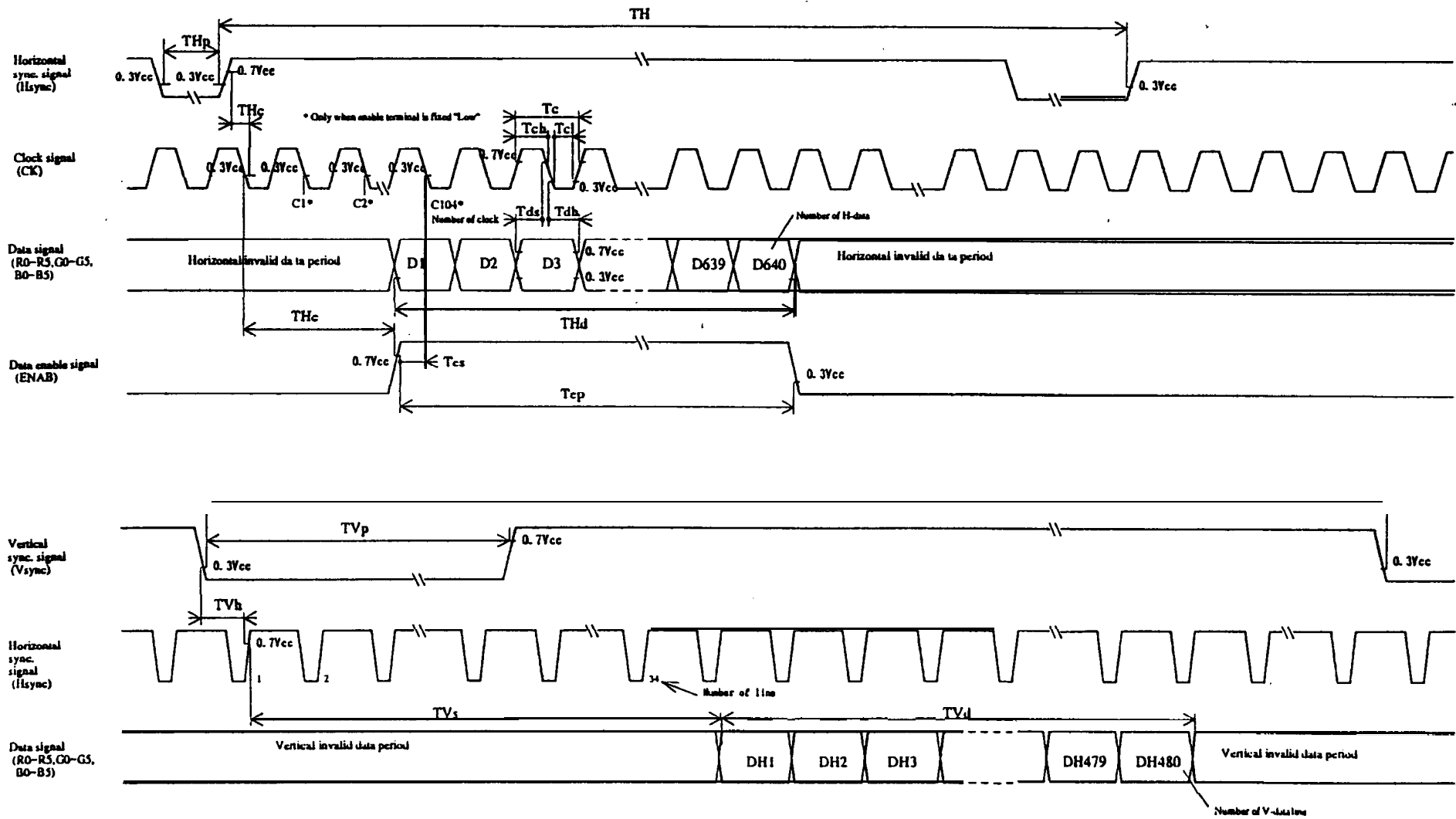

Fig 2-1 Input signal waveforms (480 line mode)

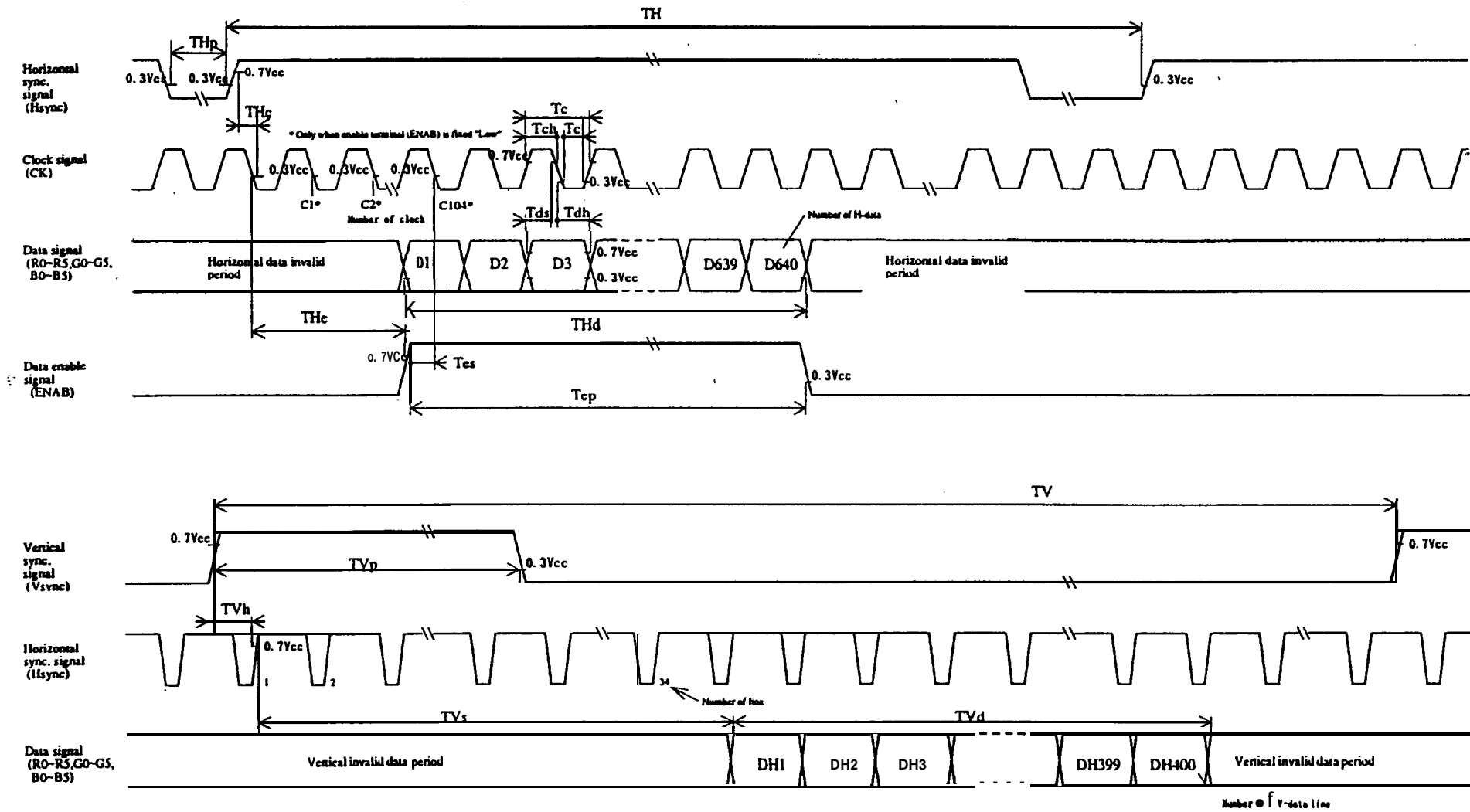

Fig.2-2 Input signal waveforms (400 line mode)

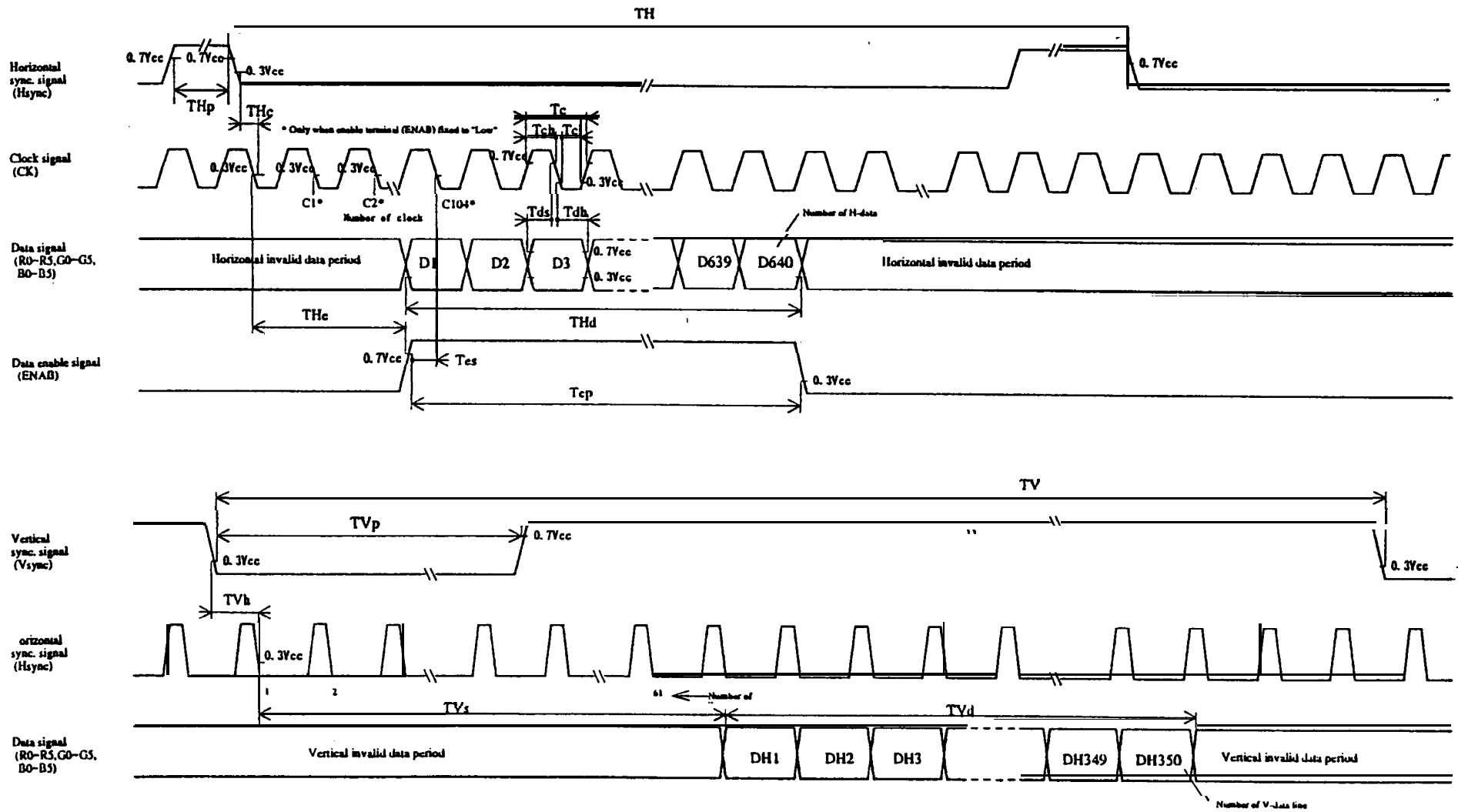

Fig.2-3 Input signal waveforms (350 line mode)

8. Input Signals, Basic Display Colors and Gray Scale of Each Color

	Colors & Gray scale	Data signal																		
		Gray Scale	R0	R1	R2	R3	R4	R5	GO	G1	G2	G3	G4	G5	BO	B1	B2	B3	B4	B5
Basic color	Black	—	0	0	0	0	0	0	0	0	0	0	0	0	0	0	0	0	0	0
	Blue	—	0	0	0	0	0	0	0	0	0	0	0	0	1	1	1	1	1	1
	Green	—	0	0	0	0	0	0	1	1	1	1	1	1	0	0	0	0	0	0
	cyan	—	0	0	0	0	0	0	1	1	1	1	1	1	1	1	1	1	1	1
	Red	—	1	1	1	1	1	1	0	0	0	0	0	0	0	0	0	0	0	0
	Magenta	—	1	1	1	1	1	1	0	0	0	0	0	0	1	1	1	1	1	1
	Yellow	—	1	1	1	1	1	1	1	1	1	1	1	1	0	0	0	0	0	0
	White	—	1	1	1	1	1	1	1	1	1	1	1	1	1	1	1	1	1	1
Gray Scale of red	Black	GS0	0	0	0	0	0	0	0	0	0	0	0	0	0	0	0	0	0	0
	↑	GS1	1	0	0	0	0	0	0	0	0	0	0	0	0	0	0	0	0	0
	Darker	GS2	0	1	0	0	0	0	0	0	0	0	0	0	0	0	0	0	0	0
	↑	↓				↓					↓						↓			
	Q	↓				↓					↓						↓			
	Brighter	GS61	1	0	1	1	1	1	0	0	0	0	0	0	0	0	0	0	0	0
	0	GS62	0	1	1	1	1	1	0	0	0	0	0	0	0	0	0	0	0	0
	Red	GS63	1	1	1	1	1	1	0	0	0	0	0	0	0	0	0	0	0	0
Gray Scale of green	Black	GS0	0	0	0	0	0	0	0	0	0	0	0	0	0	0	0	0	0	0
	↑	GS1	0	0	0	0	0	0	1	0	0	0	0	0	0	0	0	0	0	0
	Darker	GS2	0	0	0	0	0	0	0	1	0	0	0	0	0	0	0	0	0	0
	↑	↓				↓					↓						↓			
	Q	↓				↓					↓						↓			
	Brighter	GS61	0	0	0	0	0	0	1	0	1	1	1	1	0	0	0	0	0	0
	0	GS62	0	0	0	0	0	0	0	1	1	1	1	1	0	0	0	0	0	0
	Green	GS63	0	0	0	0	0	0	1	1	1	1	1	1	0	0	0	0	0	0
Gray Scale of blue	Black	GS0	0	0	0	0	0	0	0	0	0	0	0	0	0	0	0	0	0	0
	↑	GS1	0	0	0	0	0	0	0	0	0	0	0	1	0	0	0	0	0	0
	Darker	GS2	0	0	0	0	0	0	0	0	0	0	0	0	0	1	0	0	0	0
	↑	↓				↓					↓						↓			
	Q	↓				↓					↓						↓			
	Brighter	GS61	0	0	0	0	0	0	0	0	0	0	0	0	1	0	1	1	1	1
	0	GS62	0	0	0	0	0	0	0	0	0	0	0	0	0	1	1	1	1	1
	Blue	GS63	0	0	0	0	0	0	0	0	0	0	0	0	1	1	1	1	1	1

0 : Low level voltage, 1 : High level voltage

Each basic color can be redisplayed in 64 gray scales from 6 bit data signals. According to the combination of total 18 bit data signals, the 262, 144-color display can be achieved on the screen.

9. Optical Characteristics

Ta=25°C., Vcc=+5V

Parameter		Symbol	Condition	Min.	Typ.	Max.	Unit	Remark
Viewing angle range	Horizontal	$\theta 21$	(CR>5)	(60)	-	-	Deg.	【Note1,4】
		$\theta 22$		(60)	-	-	Deg.	
	Vertical	011		(40) (35)	-	-	Deg.	
		$\theta 12$		(50) (35)	-	-	Deg.	
Contrast ratio		CR	Best viewing angle	100	-	-	-	【Note2,4】
Response time	Rise	τr	$\theta = 0''$	-	30	-	ms	【Note3,4】
	Decay	τd		-	50	-	ms	
Chromaticity of white		X		-	0.313	-	-	【Note4】
		Y		-	0.329	-	-	
Luminance of white		YL	TED	(300)	-	-	cd/m ²	
White Uniformity		δw		-	-	1.45	-	【Note5】

※The measurement shall be executed 30 minutes after lighting at rating. (typical condition: $I_L = \text{TBD mA rms}$)
 The optical characteristics shall be measured in a dark room or equivalent state with the method shown in Fig.3 below.

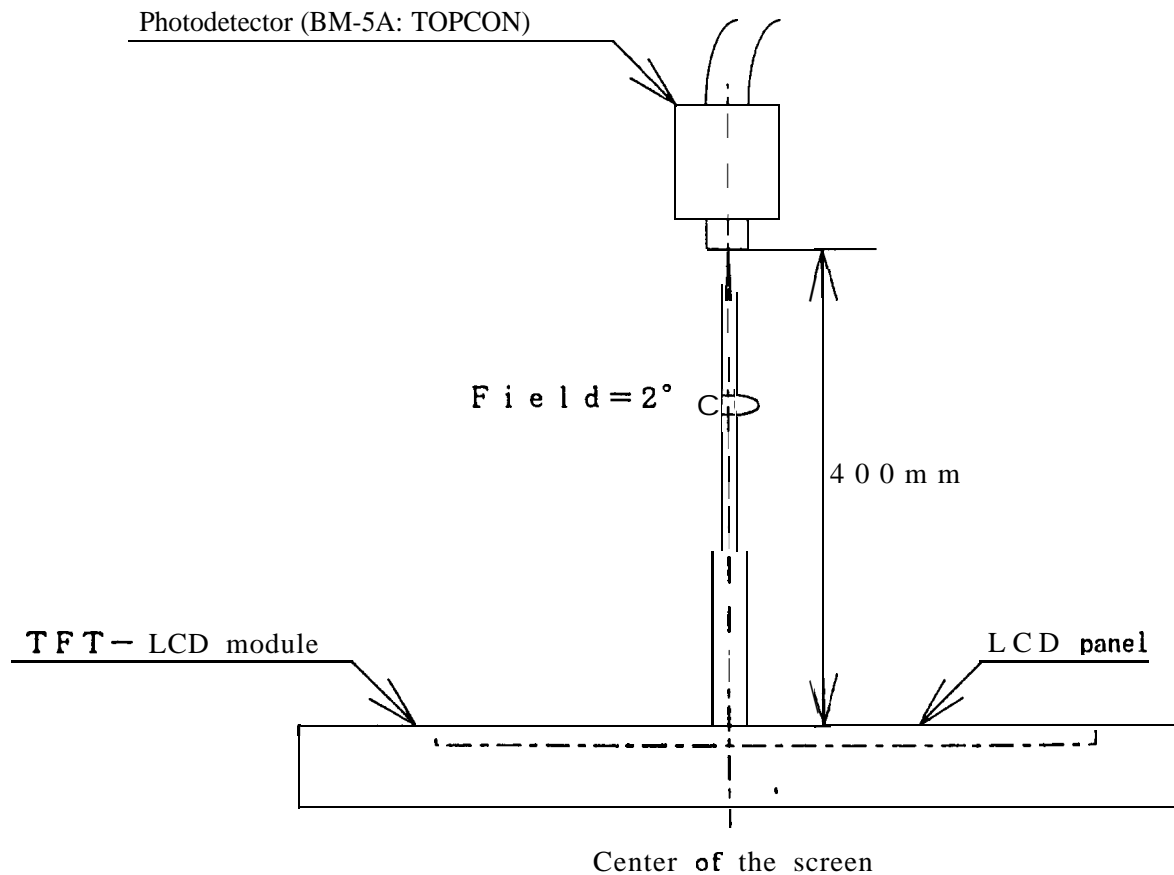
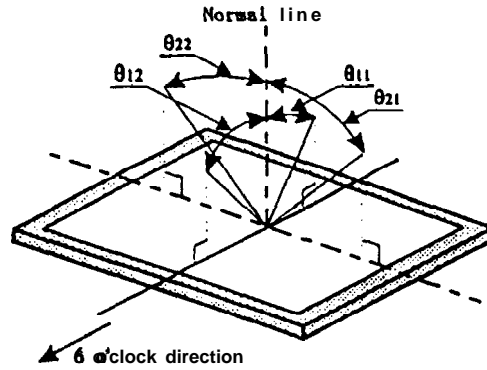

Fig. 3 Optical characteristics measurement method

【Note1】Definitions of viewing angle range:



【Note2】 Definition of contrast ratio:

The contrast ratio is defined as the following.

$$\text{Contrast Ratio (CR)} = \frac{\text{Luminance (brightness) with all pixels white}}{\text{Luminance (brightness) with all pixels black}}$$

【Note3】 Definition of response time:

The response time is defined as the following figure and shall be measured by switching the input signal for “black” and “white”.

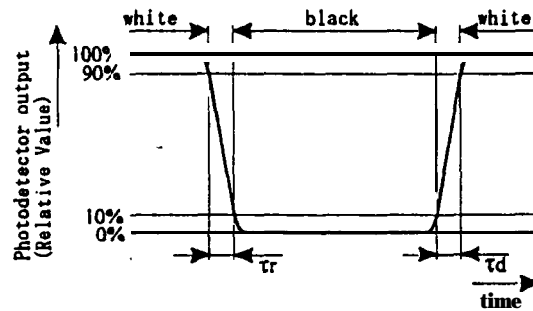

【Note4】 This shall be measured at center of the screen.

【Note5】 Definition of white uniformity:

White uniformity is defined as the following with five measurements (A~E).

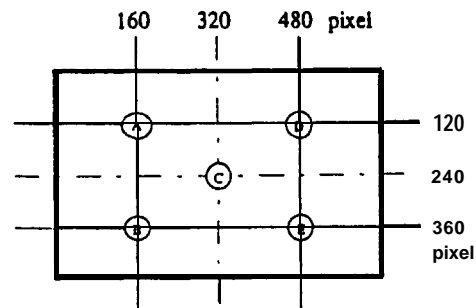

$$\delta_w = \frac{\text{Maximum Luminance of five points (brightness)}}{\text{Minimum Luminance of five points (brightness)}}$$

10. Display Quantity

TBD

11. Handling Precautions

- a) Be sure to turn off the power supply when inserting or disconnecting the cable.
- b) Be sure to design the cabinet so that the module can be installed without any extra stress such as warp or twist.
- c) Since the front polarizer is easily damaged, pay attention not to scratch it.
- d) Wipe off water drop immediately. Long contact with water may **cause** discoloration or spots.
- e) When the panel surface is soiled, wipe it with absorbent cotton or other soft cloth.
- f) Since the panel is made of glass, it may break or crack if dropped or bumped on **hard** surface. Handle with care.
- g) Since CMOS **LSI** is used in this module, take care of static electricity and injure the human earth when handling.
- h) Observe all other precautionary requirements in handling components.
- i) This module has its circuitry PCBS on the **rear** side and should be carefully handled in order not to be stressed.
- j) Laminated film is attached to the module surface to prevent it from being scratched . Peel the **film** off **slowly** , just before the use. **with** strict attention to electrostatic **charges**. **Ionized** air **shall** be blown over during the action. Blow off 'dust' on the polarizer by using an ionized nitrogen gun, etc.

12. Packing form

- a) Piling number of cartons : MAX. TBD
- b) Package quantity in one carton: TBD
- c) Carton size: TBD(W) × TBD(D) × TBD(H)mm
- d) Total mass of 1 carton filled with full modules : TBD g

13. Reliability test items

No.	Test item	Conditions
1	High temperature storage test	Ta=60°C 240h
2	Low temperature storage test	Ta=-25°C 240h
3	High temperature & high humidity operation test	Ta=40°C : 95%RH 240h (No condensation)
4	High temperature operation test	Ta=50°C 240h
5	Low temperature operation test	Ta=0°C 240h
6	Vibration test (non- operating)	Frequency : 10~57Hz/Vibration width (one side) : 0.075mm : 58~500Hz/Gravity: 9.8m/s ² Sweep time : 11 minutes Test period : 3 hours (1 hour for each direction of X,Y,Z)
7	Shock test (non- operating)	Max. gravity: 490m/s ² Pulse width: 11 ms, half sine wave Direction: ±X, ±Y, ±Z once for each direction.

[Result Evaluation Criteria]

Under the display quality test conditions with normal operation state, these shall be no change which may affect practical display function.

14. Others

1) Lot No. Label:

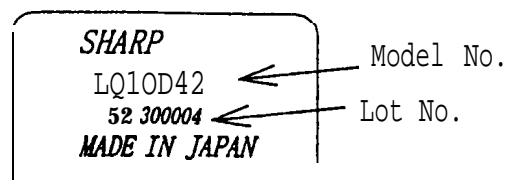

- 2) Adjusting volume have been set optimally before shipment, so do not change any adjusted value.
If adjusted value is changed, the specification may not be satisfied.
- 3) Disassembling the module can cause permanent damage and should be strictly avoided.
- 4) Please be careful since image retention may occur when a **fixed** pattern is displayed for a long time.
- 5) **If** any problem occurs in relation to the description of this specification , it **shall** be resolved through discussion with spirit of **cooperation**.

LAMP UNIT
REMOVING DIRECTION

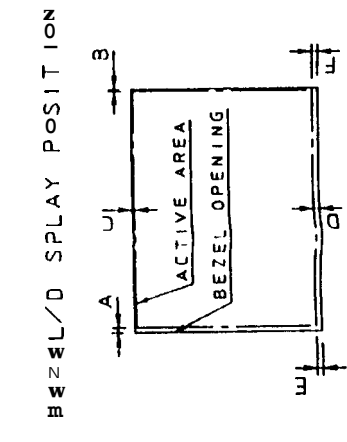
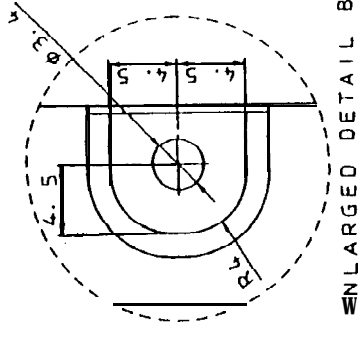
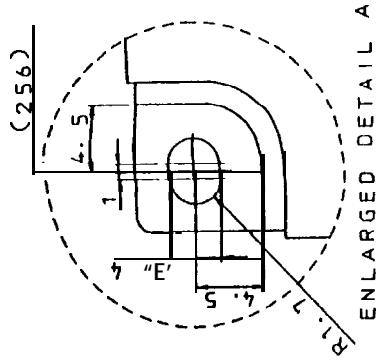
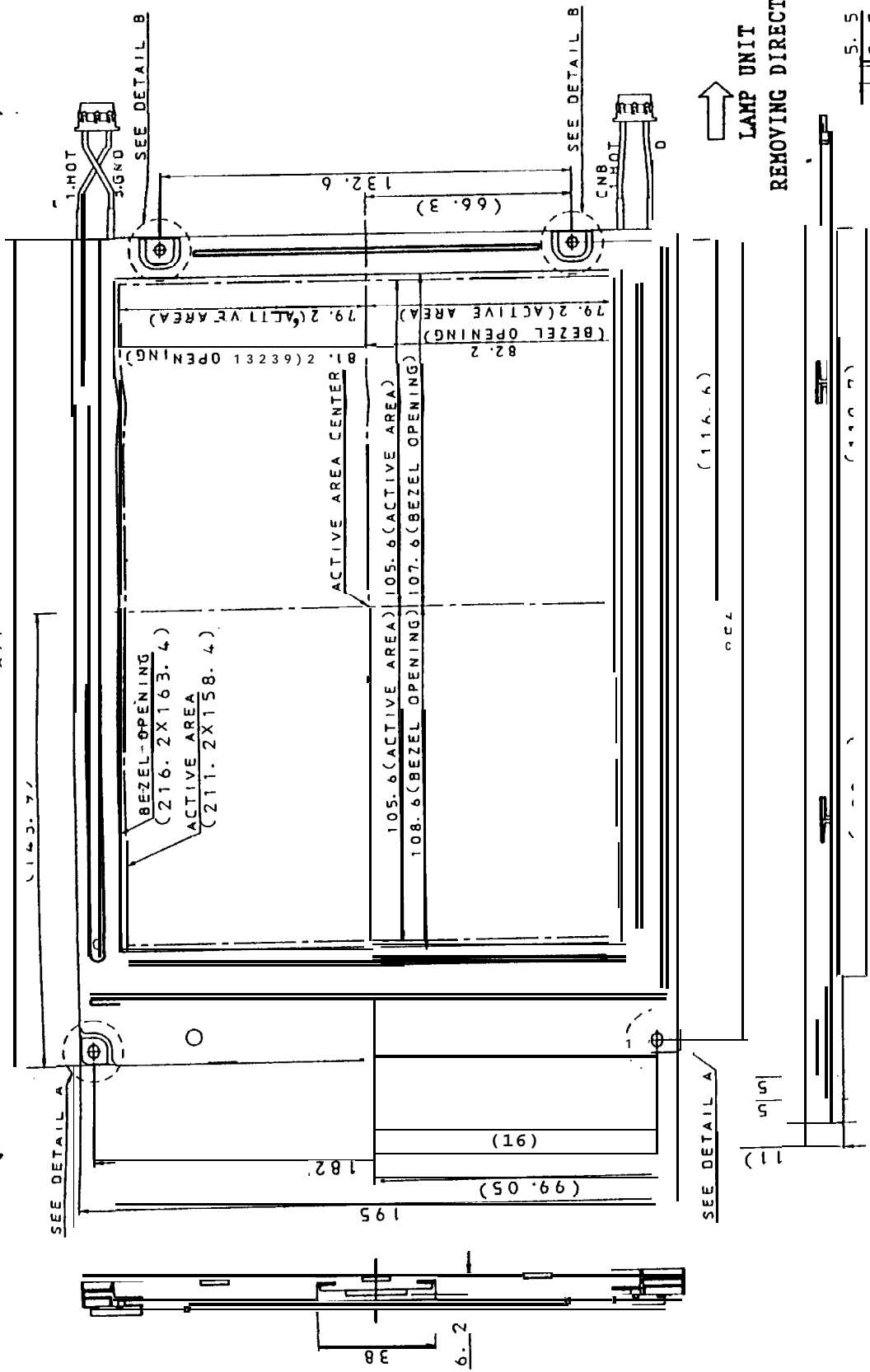

- ① TOLERANCE
- ② TOLERANCE
- ③ TOLERANCE
- ④ TOLERANCE
- ⑤ TOLERANCE
- ⑥ TOLERANCE
- ⑦ TOLERANCE
- ⑧ TOLERANCE
- ⑨ TOLERANCE
- ⑩ TOLERANCE
- ⑪ TOLERANCE
- ⑫ TOLERANCE
- ⑬ TOLERANCE
- ⑭ TOLERANCE
- ⑮ TOLERANCE
- ⑯ TOLERANCE
- ⑰ TOLERANCE
- ⑱ TOLERANCE
- ⑲ TOLERANCE
- ⑳ TOLERANCE
- ㉑ TOLERANCE
- ㉒ TOLERANCE
- ㉓ TOLERANCE
- ㉔ TOLERANCE
- ㉕ TOLERANCE
- ㉖ TOLERANCE
- ㉗ TOLERANCE
- ㉘ TOLERANCE
- ㉙ TOLERANCE
- ㉚ TOLERANCE
- ㉛ TOLERANCE
- ㉜ TOLERANCE
- ㉝ TOLERANCE
- ㉞ TOLERANCE
- ㉟ TOLERANCE
- ㊱ TOLERANCE
- ㊲ TOLERANCE
- ㊳ TOLERANCE
- ㊴ TOLERANCE
- ㊵ TOLERANCE
- ㊶ TOLERANCE
- ㊷ TOLERANCE
- ㊸ TOLERANCE
- ㊹ TOLERANCE
- ㊺ TOLERANCE
- ㊻ TOLERANCE
- ㊼ TOLERANCE
- ㊽ TOLERANCE
- ㊾ TOLERANCE
- ㊿ TOLERANCE

NOTES
*UNSPECIFIED TOLERANCES TO BE $\pm 0. 5$

FIG1 LQ10042 OUTLINE DIMENSIONS