

PREPARED BY: _____ DATE _____

APPROVED BY: _____ DATE _____

SHARP

LIQUID CRYSTAL DISPLAY GROUP
SHARP CORPORATION

SPECIFICATION

FILE No. _____

ISSUE: May. 11. 1994

PAGE : 18 pages

APPLICABLE GROUP

Liquid Crystal Display
Group

EXT: 146

DEVICE SPECIFICATION FOR

TFT-LCD Module

MODEL No.

LQ10D031

CUSTOMER'S APPROVAL

DATE _____

BY _____

PRESENTED BY H. Fukuoka

H. FUKUOKA
 Department General Manager
 Engineering Department 2
 TFT LCD Development Center
 LIQUID CRYSTAL DISPLAY GROUP
 SHARP CORPORATION

J. P. Act

RECORDS OF REVISION

SPEC No.	DATE	REVISED No.	SUMMARY		NOTE
				PAGE	
LD-6501	-	-			1st Issue
LD-6501A	JUN. 29. 1994	A	1	3. Mechanical Specifications (Haze) (25*6)	2nd Issue (Added)
			2	4-1)TFT-LCD panel driving [Note2] [Note1]	(Added) (Added)
			3	4-1)TFT-LCD panel driving Fig 4-2)Backlight driving CN A Pin2	(Added) (Added)
			4	In sheet LD6601-4. appended the last lines.	(Added)
			5	7-1. Timing characteristics Frequency(clock) Max. 31.50(MHz) → 28.33(MHz)	(Changed)
				7-2. Horizontal display position and Data enable signal. • Hsync-Enable signal phase difference Min. 84(clock) → 44(clock) Max. 204(clock) → 164(clock)	(Changed)
			6-8	Fig. 2-①-③ Input signal waveforms TTL level → C-MOS level	(Changed)
			11	Fig. 3 BM-5 → BM-5A	(Changed)
			14	14. Others 4)	(Added)
LD-6501B	SEP. 1. 1994	B	13	11-3)Others h)Caution for stress has been added	3rd issue (Added)

RECORDS OF REVISION

SPEC No.	DATE	REVISED No.	PAGE	SUMMARY	NOTE	
LD-6501C	SEP. 20. 1994	C	3	5. Absolute Maximum Ratings	3rd Issue	
				Operating temperature(Top)		
				0-+50°C → 0-+40°C	(Changed)	
			4	6-2) Backlight		
				Lamp current(I _L)		
				Max. 4.0mA → 6.0mA	(Changed)	
				Note 1.2	(Changed)	
				Note	(Deleted)	
			5	7-1. Timing characteristics		
				Frequency(clock)		
				Max. 28.33(MHz) → 31.5(MHz)	(Changed)	
11				9. Optical Characteristics		
				Luminance of white(Y ₁)		
				Min. 45cd/m ² Typ. 65cd/m ²		
				↓		
				Luminance of white(Y _{1.1})		
				Min. 45cd/m ² Typ. 65cd/m ²		
14				Luminance of white(Y _{1.2})		
				Min. 85cd/m ² Typ. 100cd/m ²	(Changed)	
				13. Reliability test items		
				4 High temperature operation test	-	
				Ta=50°C → Ta=40°C	(Changed)	
				14.16	UL/CSA Label	(added)
				14.16.17	Bar code Label 73G7606 → 73G7605	(Changed)
LD-6501D	OCT. 12. 1994	D	1	Display size - Diagonal	(Changed)	
			3	5. Operating temperature	(Added)	
				I _L =3.5mA, 6.0mA		

1. Application

This specification applies to color TFT-LCD module, LQ10D031.

2. Overview

This module is a color active matrix LCD module incorporating amorphous silicon TFT (Thin Film Transistor). It is composed of a color TFT-LCD panel, driver ICs, control circuit, power supply circuit and a backlight unit. Graphics and texts can be displayed on a 640x3x480 dots panel in 4.096 colors by supplying 12 bit data signal, four timing signals, +5V DC supply voltage for TFT-LCD panel driving and supply voltage for backlight. Optimum viewing direction is 6 o'clock.

The 400 line and 350 line modes in addition to the 480 line modes can be also applied for this module.

Backlight-driving DC/AC inverter is not built in this module.

3. Mechanical Specifications

Parameter	Specifications	Unit
Diagonal	26 (10.4") 	cm
Active area	211.2(H) x 158.4(V)	mm
Pixel format	640(H) x 480(V) (1 pixel = R + G + B dots)	pixels
Pixel pitch	0.33(H) x 0.33(V)	mm
Pixel configuration	R, G, B vertical stripe	
Display mode	Normally white	
Unit outline dimensions	242.8(W) x 183.6(H) x 8.3(D) (MAX)	mm
Mass	480 ± 10	g
Screen surface treatment (Haze)	Anti-glare and hard-coating 2H (25±5)	(%)

Outline dimensions are shown in Fig. 1-1.0

LQ100031

LD6501-2

4. Input/Output Terminals
 4-1) TFT-LCD panel driving
 CN1 (Interface signal)

Used connector:DF9B-31P-1V (Hirose Electric Co.,Ltd.)

Corresponding connector:DF9 -31S-1V ()
 DF9A-31S-1V ()
 DF9B-31S-1V ()

Pin No.	Symbol	Function	Remark
1	GND		
2	T2/GND	Terminal to sense the display type(to be grounded)	
3	NC	This is electrically opened.	
4	NC	This is electrically opened.	
5	Vsync	Vertical synchronous signal	【Note1】
6	Hsync	Horizontal synchronous signal	【Note1】
7	CK	Clock signal for sampling each data signal	
8	GND		
9	R3	RED data signal (MSB)	
10	R2	RED data signal	
11	R1	RED data signal	
12	R0	RED data signal (LSB)	
13	GND		
14	G0	GREEN data signal (LSB)	
15	NC	This is electrically opened.	
16	ENAB	Data enable signal (to settle the viewing area)	【Note2】
17	Vcc	+ 5V power supply	
18	Vcc	+ 5V power supply	
19	NC	This is electrically opened.	
20	B3	BLUE data signal (MSB)	
21	GND		
22	NC	This is electrically opened.	
23	G3	GREEN data signal (MSB)	
24	G2	GREEN data signal	
25	G1	GREEN data signal	
26	T1/NC	Terminal to sense the display type(to be opened)	
27	B2	BLUE data signal	
28	B1	BLUE data signal	
29	B0	BLUE data signal (LSB)	
30	NC	This is electrically opened.	
31	GND		

【Note1】 Polarity of the sync. signals.

mode	480 lines	400 lines	350 lines
Hsync	negative	negative	positive
Vsyn	negative	positive	negative

It is equivalent to 480line mode if the both synchronous signals are positive. But the vertical display start timing is different from the normal 480line mode in this case.

※The shielding case is connected with GND.

LQ100051

【Note1】

Vcc-turn-on conditions

- t1: rise time ($0 \leq t \leq 10\text{ms}$)
- t2: data input allowance time ($0 \leq t \leq 32\text{ms}$)

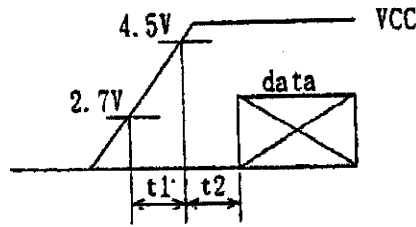

Vcc-dip conditions

- 1) $2.7\text{V} \leq V_{cc} < 4.5\text{V}$
td: Vcc-dip time ($\leq 10\text{ms}$)
- 2) $V_{cc} < 2.7\text{V}$
(Vcc-dip conditions should also follow the Vcc-turn-on conditions)

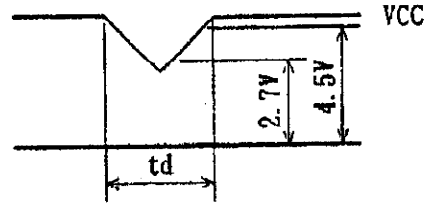

【Note2】 Typical current situation : Black pattern.
(at 480 line mode. Vcc=5V)

【Note3】 CK.R0-R3.G0-G3.B0-B3.Hsync.Vsync.ENAB

【Note4】 CK.R0-R3.G0-G3.B0-B3.Hsync.Vsync

【Note5】 ENAB

6-2. Backlight

The backlight system is an edge-lighting type with single CCFT.
The characteristics of lamp are shown in the following table.

Ta=25°C

Parameter	Symbol	Min.	Typ.	Max.	Unit	Remark
Lamp voltage	V _L	—	600	—	V _{rms}	Just for reference
Lamp current	I _L	2.5	3.5	6.0	mA _{rms}	【Note 1】 ▲ ▲
Lamp power consumption	P _L	—	2.1	—	W	【Note 2】
Lamp frequency	F _L	20	—	60	kHz	
Kick-off voltage	V _s	—	—	1300	V _{rms}	Ta=25°C
		—	—	1500	V _{rms}	Ta=0°C
Lamp life time	T _L	10000	—	—	h	【Note 3】

【Note 1】 Available current range considering light-adjustment.

【Note 2】 Calculated value for reference. (I_L×V_L)

【Note 3】 Brightness becomes 50% of the original value under standard condition.
(I_L=3.5mA_{rms})

LQ100031

LD6501-3

【Note2】 The horizontal display start timing is settled with a rising timing of this signal. In case ENAB is fixed "Low". The horizontal start timing is determined in the module. (refer to 7-2)

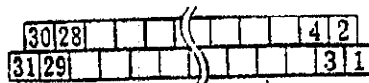

CN1 pin No.

4-2) Backlight driving

Used connector : BHR-03VS-1(JST)

Corresponding connector:SM02(8.0)B-BHS-1(JST)

CNA

Pin no.	symbol	function
1	V _{HIGH}	Power supply for lamp (High voltage side)
2	N C	This is electrically opened.
3	V _{LOW}	Power supply for lamp (Low voltage side)

5. Absolute Maximum Ratings

Parameter	Symbol	Condition	Ratings	Unit	Remark
Input voltage	V _i	Ta=25°C	-0.3 ~ Vcc+0.3	V	【Note1】
+5V supply voltage	Vcc	Ta=25°C	0 ~ +7	V	
Storage temperature	Tstg	-	-25 ~ +60	°C	【Note2】
Operating temperature (Ambient)	Topa	I _L =3.5mA	0 ~ +50	°C	△
		I _L =6.0mA	0 ~ +40	°C	

【Note1】 CK, R0~R3, G0~G3, B0~B3. Hsync, Vsync, ENAB

【Note2】 Humidity : 95%RH Max. at Ta≤40°C.

Maximum wet-bulb temperature 39°C or less at Ta>40°C.

No condensation.

6. Electrical Characteristics

6-1. TFT-LCD panel driving

Ta = 25°C

Parameter	Symbol	Min.	Typ.	Max.	Unit	Remark
+5V Supply voltage	Vcc	+4.5	+5.0	+5.5	V	【Note1】
	Icc	-	200	500	mA	【Note2】
Permissible input ripple voltage	V _{rip}	-	-	100	mVp-p	Vcc
Input voltage (Low)	V _{IL}	-	-	+1.5	V	Vcc=+5V
Input voltage (High)	V _{IH}	+3.5	-	-	V	【Note3】
Input current (low)	I _{OL}	-	-	1.0	μA	V _i =0V
		-	-	1.0	μA	【Note3】
Input current (High)	I _{OH}	-	-	1.0	μA	V _i =Vcc
		-	-	25.0	μA	【Note4】
						V _i =Vcc
						【Note5】

7. Timing Characteristics of input signals

※ Input signal waveforms are shown in Fig.2-0-0.

7-1. Timing characteristics

Parameter		Symbol	Mode	Min.	Typ.	Max.	Unit	Remark
Clock	Frequency	1/Tc	all	-	25.18	31.5	MHz	△
	High time	Tch	"	5	-	-	ns	
	Low time	Tcl	"	10	-	-	ns	
Data	Setup time	Tds	"	5	-	-	ns	
	Hold time	Tdh	"	10	-	-	ns	
Horizontal sync. signal	Cycle	TH	"	30.00	31.78	-	μs	
			"	770	800	900	clock	
	Pulse width	THp	"	2	96	200	clock	
Vertical sync. signal	Cycle	TV	480	515	525	560	line	
			400	445	449	480	line	
			350	447	449	510	line	
	Pulse width	TVp	all	2	-	34	line	
Horizontal display period		THd	"	640	640	640	clock	
Hsync-Clock phase difference		THc	"	10	-	Tc-10	ns	
Hsync-Vsync phase difference		TVh	"	0	-	TH-THp	ns	

Note) In case of lower frequency, the deterioration of display quality, flicker etc..may be occurred.

7-2. Horizontal display position and Data enable signal

Horizontal display position is settled by data enable signal, horizontal display starts from rising of the data enable signal.

Timing characteristics

Parameter		Symbol	Mode	Min.	Typ.	Max.	Unit	Remark
Enable signal	Setup time	Tes	all	5	-	Tc-10	ns	
	Pulse width	Tep	"	2	640	640	clock	
Hsync-Enable signal phase difference		THE	"	44	-	164	clock	

Note) If data enable terminal (ENAB) is fixed "Low", the display starts from the data of C104(clock) as shown in Fig.2-1-3.

7-3. Vertical display position

If sync. signals have the polarity described in 4-1, note1 and values in the following table, the vertical display position is automatically centered at each mode of VGA 480 line, 400 line and 350 line modes. The data enable signal have no relation to the vertical display position.

mode	V-data start(TVs)	V-data period(TVd)	V-display start	V-display period	Unit	Remark
480	34	480	34	480	line	
400	34	400	443-TV	480	line	[Note1]
350	61	350	445-TV	480	line	

[Note1] Since the data in vertical invalid data period is also displayed in 400 and 350 line mode, inputting all data "0" is recommended during data invalid period. (refer to the following figures)
In 400 and 350 line mode, the display position will not be centered on the screen if the cycle of vertical sync. signal, TV, deviates from above typical values.

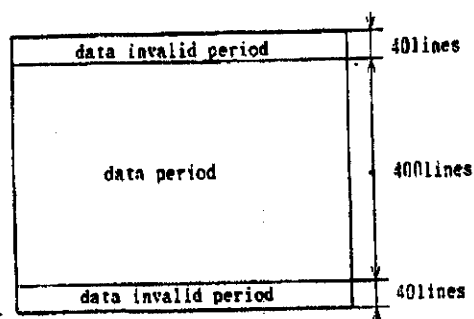

400 line mode (TV=449)

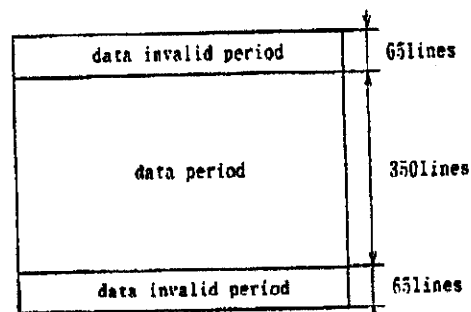

350 line mode (TV=449)

7-4. Input Data Signals and Display Position on the screen

Display position of input data (480 line mode)
(H-V)

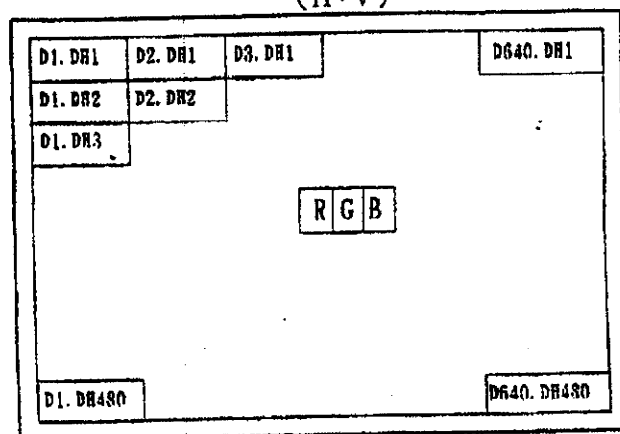

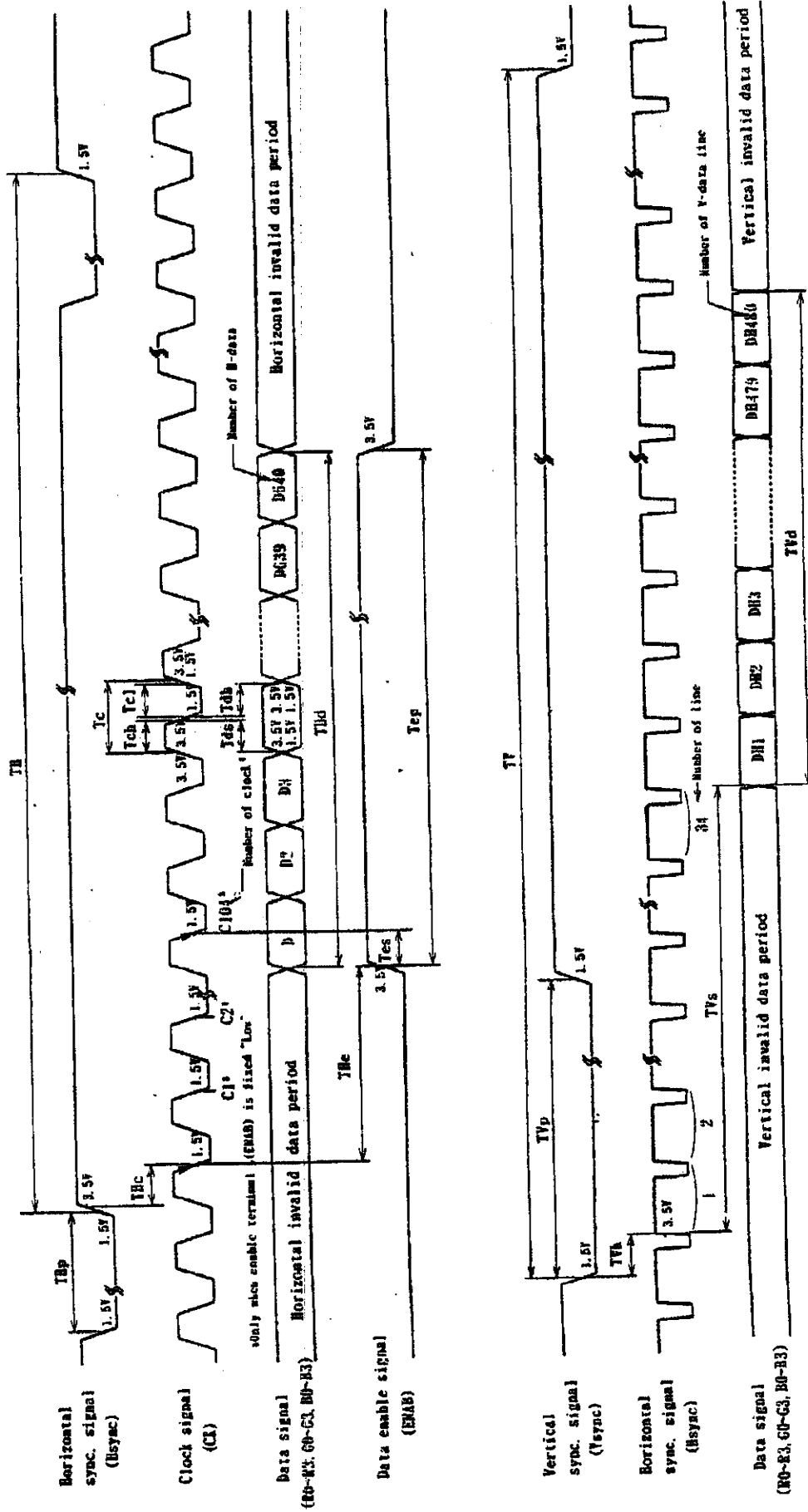

Fig. 2-0 Input signal waveforms (480 line mode)

8. Input Signals, Basic Display Colors and Gray Scale of Each Color

	color & Gray scale	Data signal											
		R0	R1	R2	R3	G0	G1	G2	G3	B0	B1	B2	B3
Basic color	Black	0	0	0	0	0	0	0	0	0	0	0	0
	Blue	0	0	0	0	0	0	0	0	1	1	1	1
	Green	0	0	0	0	1	1	1	1	0	0	0	0
	Light blue	0	0	0	0	1	1	1	1	1	1	1	1
	Red	1	1	1	1	0	0	0	0	0	0	0	0
	Purple	1	1	1	1	0	0	0	0	1	1	1	1
	Yellow	1	1	1	1	1	1	1	1	0	0	0	0
	White	1	1	1	1	1	1	1	1	1	1	1	1
Gray Scale of Red	Black	0	0	0	0	0	0	0	0	0	0	0	0
	↑	1	0	0	0	0	0	0	0	0	0	0	0
	Darker	0	1	0	0	0	0	0	0	0	0	0	0
	↑												
	↓												
	Brighter	1	0	1	1	0	0	0	0	0	0	0	0
	↓	0	1	1	1	0	0	0	0	0	0	0	0
	Red	1	1	1	1	0	0	0	0	0	0	0	0
Gray Scale of Green	Black	0	0	0	0	0	0	0	0	0	0	0	0
	↑	0	0	0	0	1	0	0	0	0	0	0	0
	Darker	0	0	0	0	0	1	0	0	0	0	0	0
	↑												
	↓												
	Brighter	0	0	0	0	1	0	1	1	0	0	0	0
	↓	0	0	0	0	0	1	1	1	0	0	0	0
	Green	0	0	0	0	1	1	1	1	0	0	0	0
Gray Scale of Blue	Black	0	0	0	0	0	0	0	0	0	0	0	0
	↑	0	0	0	0	0	0	0	0	1	0	0	0
	Darker	0	0	0	0	0	0	0	0	0	1	0	0
	↑												
	↓												
	Brighter	0	0	0	0	0	0	0	0	1	0	1	1
	↓	0	0	0	0	0	0	0	0	0	1	1	1
	Blue	0	0	0	0	0	0	0	0	1	1	1	1

0: Low level
voltage
1: High level
voltage

Each colors are displayed in 16 gray scales from 4 bit data signals input.
According to the combination of total 12 bit data, 4096 colors are displayed.

9. Optical Characteristics

Ta=25°C, Vcc=+5V

Parameter	Symbol	Condition	Min.	Typ.	Max.	Unit	Remark	
Viewing angle range	Horizontal	CR>10	3.5	-	-	°	【Note1,4】	
	Vertical		θ_{11}	1.0	-	-		°
			θ_{12}	3.0	-	-		°
Contrast ratio	CR	Optimum viewing angle	6.0	-	-		【Note2,4】	
Response time	Rise	$\theta=0^\circ$	-	3.0	-	ms	【Note3,4】	
	Decay		-	5.0	-	ms		
Chromaticity of white	x		-	0.313	-		【Note4】	
			y	-	0.329	-		
Luminance of white	I _L =3.5mA	Y _{L1}	4.5	6.5	-	cd/m ²		
	I _L =6.0mA	Y _{L2}	8.5	10.0	-	cd/m ²		
White Uniformity	δ_w		-	-	1.45		【Note5】	
Shadowing	S		-	-	2.0	%	【Note6】	

※The measurement shall be executed 15-20 minutes after lighting by using the standard inverter(aa-617). The optical characteristics shall be measured in a dark room or equivalent state with the method shown in Fig.3 below.

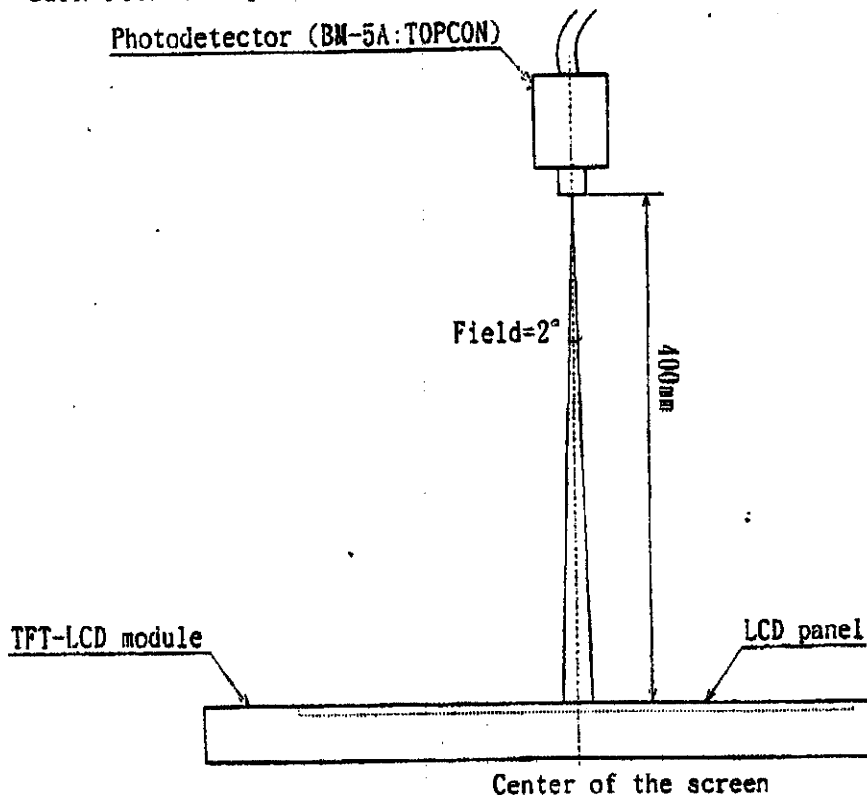
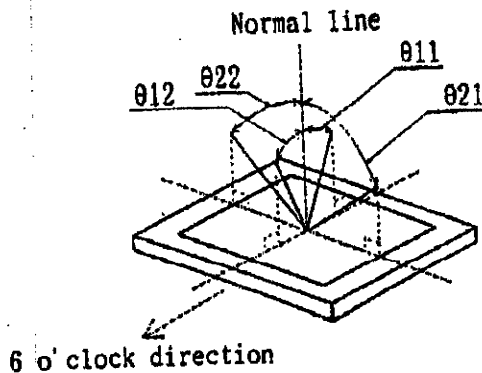

Fig.3 Optical characteristics measurement method

【Note1】 Definitions of viewing angle range:



【Note2】 Definition of Contrast Ratio:

The contrast ratio is defined as the following.

$$\text{Contrast Ratio} = \frac{\text{Luminance (brightness) with all pixels white}}{\text{Luminance (brightness) with all pixels black}}$$

【Note3】 Definitions of Response Time:

The response time is defined as the following figure (r, r_d) by switching the input signals for "black" and "white".

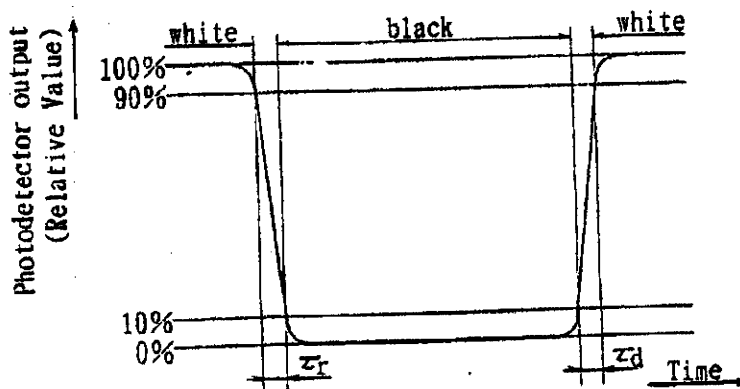

【Note4】 This shall be measured at center of the screen.

【Note5】 Definition of White Uniformity
White Uniformity is defined as the following with five measurements (A-E).

$$\frac{\text{Maximum Luminance of five points (brightness)}}{\text{Minimum Luminance of five points (brightness)}}$$

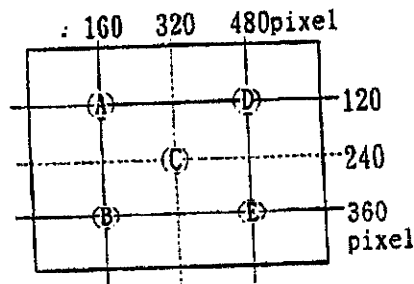

[Note6] Definition of Shadowing Δ
 Shadowing is defined as follows.

$$S = (|YA - YB| / YA) \times 100(\%)$$

YA&YB: Brightness of same measured area

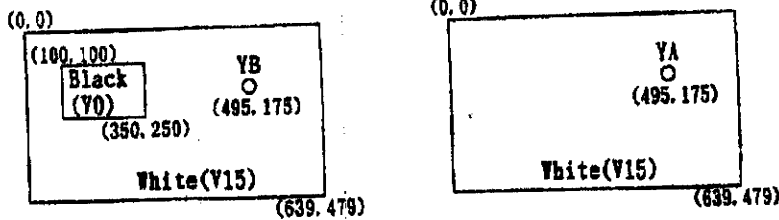

10. Display quality

The display quality of the color TFT-LCD module shall be in compliance with the Incoming Inspection Standard.

11. Handling Precautions

- 11-1) Be sure to turn off the power supply when inserting or disconnecting the cable from the input connector.
- 11-2) Power OFF sequential timing
 To prevent the latch-up of the circuit in the module, keep the sequential timing between the input signals and supply voltage as follows.

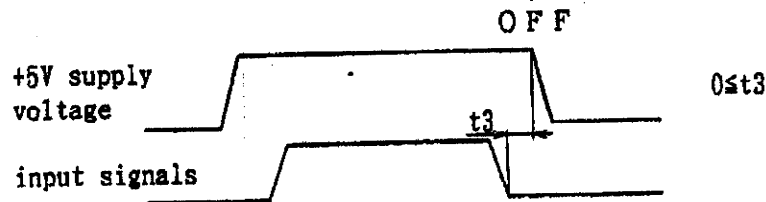

11-3) Others

- Be sure to design the cabinet so that the module can be installed without any extra stress such as warp or twist.
- Since the front polarizer is easily damaged, pay attention not to scratch it.
- Wipe off water drop immediately. Long contact with water may cause discoloration or spots.
- When the panel surface is soiled, wipe it with absorbent cotton or other soft cloth.
- Since the panel is made of glass, it may break or crack if dropped or bumped on hard surface. Handle with care.
- Since CMOS LSI is used in this module, take care of static electricity and insure human earth when handling.
- Observe all other precautionary requirements in handling components.
- This module has its circuitry PCBs on the rear side and should be carefully handled in order not to be stressed. Otherwise possibility occurs that some of the components are damaged.

- i) Don't use any materials which emit following gas from epoxy resin(Amines'hardner) and silicone adhesive agent(Dealcohol or deoxym) to prevent change polarizer color owing to gas. ▲
- j) Laminated film is attached to the module surface to prevent it from being scratched. Peel the film off slowly, just before the use, with strict attention to electrostatic charges. Ionized air shall be blown over during the action. Blow off 'dust' on the polarizer by using an ionized nitrogen gun, etc. ▲

12. Packing form

- a) Piling number of cartons : MAX.7
- b) Package quantity in one carton : MAX.10
- c) Carton size : 413(W)x288(H)x351(D)mm
- d) Total mass of 1 carton filled with full modules : 7500g
- Packing form is show in Fig.4.

13. Reliability test items

No.	Test item	Conditions
1	High temperature storage test	Ta=60°C 240h
2	Low temperature storage test	Ta=-25°C 240h
3	High temperature & high humidity operation test	Ta=40°C:95%RH 240h (No condensation)
4	High temperature operation test	Ta=40°C 240h (The panel temp. must be less than 60°C)
5	Low temperature operation test	Ta=0°C 240h
6	Vibration test (non-operating)	Frequency:10-57Hz/Vibration width (one side):0.075mm :58-500Hz/Gravity:9.8m/s ² Sweep time : 11 minutes Test period : 3 hours (1 hour for each direction of X, Y, Z)
7	Shock test (non-operating)	Max. gravity : 490m/s ² Pulse width : 11ms, half sine wave Direction : ±X, ±Y, ±Z once for each direction.

【Result Evaluation Criteria】

Under the display quality test conditions with normal operation state, these shall be no change which may affect practical display function.

14. Others

1-1) Bar code Label:

Model No.

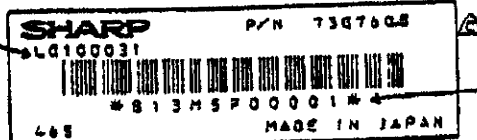

Lot No.

1-2) Caution-Label:

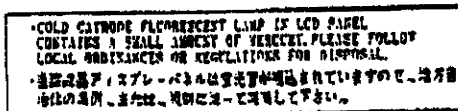

1-3) UL/CSA Label:

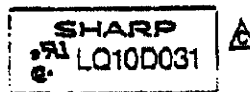

- 2) Adjusting voltage has been set optimally before shipment, so do not change any adjusted value. If adjusted value is changed, the data mentioned in this specification may not be satisfied.
- 3) Disassembling the module can cause permanent damage and should be strictly avoided.
- 4) Please be careful since image retention may occur when a fixed pattern is displayed for a long time.
- 5) If any problem occurs in relation to the description of this specification, it shall be resolved through discussion with spirit of cooperation.

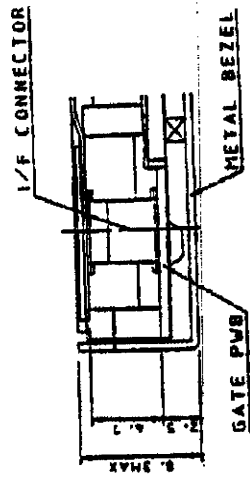
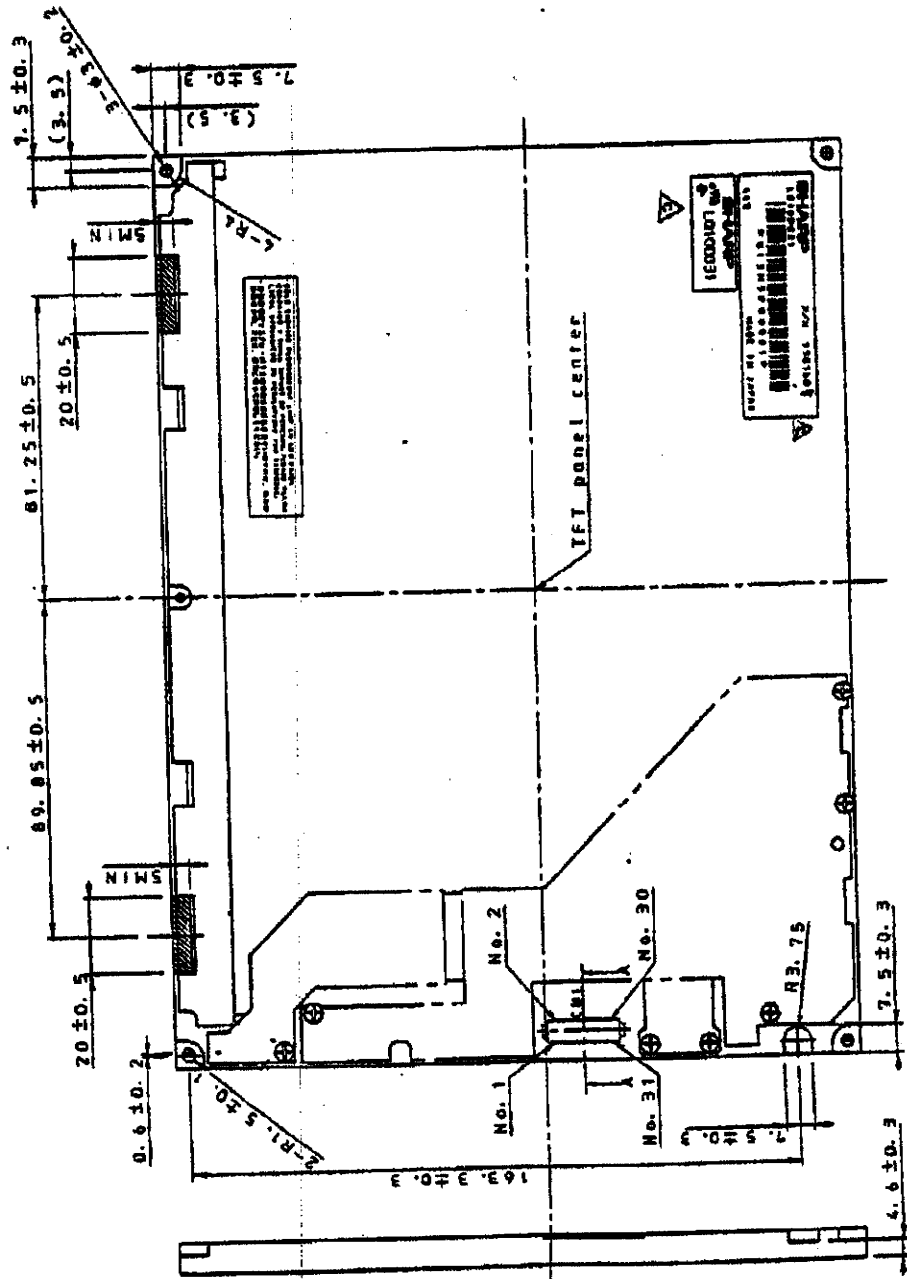

A-A Section

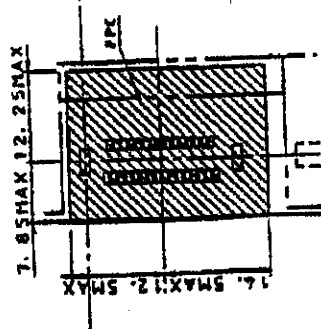

Dimensions of open area for I/F-PCB connector

UNSPECIFIED TOLERANCE TO BE ± 0.5

Fig. 1-0 Outline dimensions (rear side)

TFT-LCD Module

Top

Static electricity protective sack

Fixing of backlight wire

Top pad

Sheet

Partition

S=50±10

W=50

S=50±10

Carton

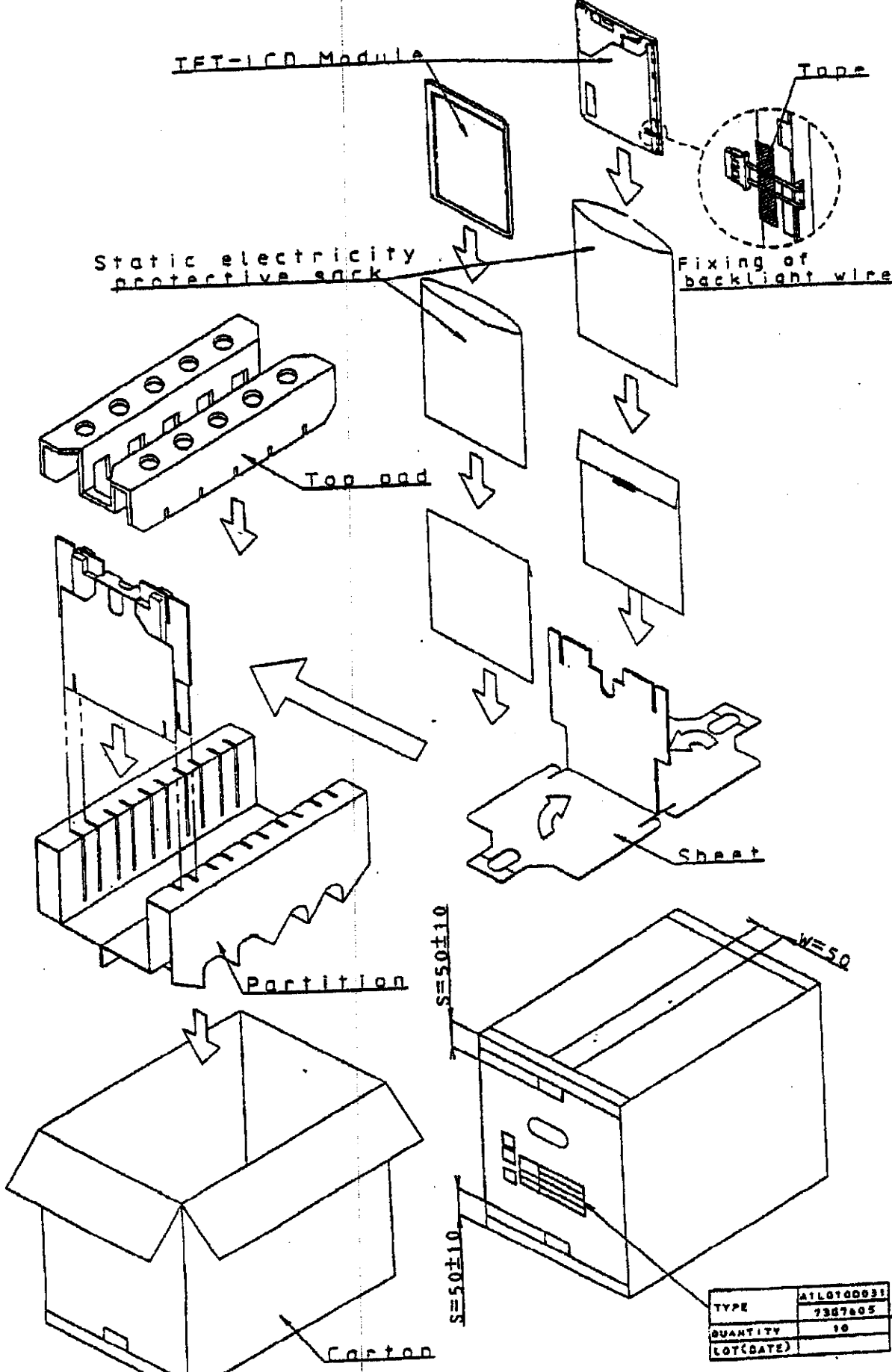

TYPE	A1L0T00831
QUANTITY	10
LOT(SATE)	