



Chunghwa Picture Tubes, Ltd.

Product Specification

Date : 100203

TFT LCD

CLAA070LD0DCW

ACCEPTED BY : (V0.3)

Tentative

APPROVED BY	CHECKED BY	PREPARED BY
張聖暉	李家銘	劉紀平

Prepared by :

Product Planning Management Division
Small & Medium TFT Product Business Unit

CHUNGHWA PICTURE TUBES, LTD.

1127 Hopin Rd., Padeh, Taoyuan, Taiwan 334, R.O.C.
TEL: +886-3-3675151 FAX: +886-3-377-3858

Doc.No: SPEC_CLAA070LD0DCW_V0.3_100203

Issue Date:

2009/10/08

REVISION STATUS

Revision Notice	Description	Page	Rev. Date
0.0	First revision	--	2009.04.08
0.1	Revise Back light parts & input CN2 (LED backlight)	P.7 & P.9	2009.05.13
	Revise MECHANICAL DIMENSION(Front & Rear Side)	P.13	
	Revise optical characteristics (response time & view angle)	P.14	
0.2	Revise Reliability test (Thermal Shock condition)	P.16	2009.09.15
0.3	Revise Gamma Voltage & Common Voltage	P.6	2009.10.02
	Revise Cell Color Coordinate of optical characteristics	P.14	2009.10.08

Contents

1. OVERVIEW	4
2. ABSOLUTE MAXIMUM RATINGS	5
3. ELECTRICAL CHARACTERISTICS	6
3.1 TFT-LCD Power Voltage.....	6
3.2 TFT-LCD Current Consumption.....	6
3.3 Power 、 Signal sequence.....	7
3.4 Back Light.....	7
4. INTERFACE CONNECTION	8
4.1 CN1.....	8
4.2 CN2 (LED backlight)	9
5. INPUT SIGNAL	10
5.1 Timing Specification.....	10
5.2 Timing sequence(Timing chart)	10
6. MECHANICAL DIMENSION	13
6.1 Front Side	13
6.2 Rear Side.....	13
7. OPTICAL CHARACTERISTICS	14
8. RELIABILITY TEST	16
8.1. Temperature and humidity.....	16
8.2. Shock and Vibration.....	16
8.3 Judgment standard	16

1. OVERVIEW

CLAA070LD0DCW is 7" color TFT-LCD (Thin Film Transistor Liquid Crystal Display) module. Composed of LCD panel, driver ICs, control circuit, and LED backlight.

The 7.0" screen produces a high resolution image that is composed of 800×480 pixel elements in a stripe arrangement.

General specifications are summarized in the following table :

ITEM	SPECIFICATION
Display Area (mm)	152.4(H)×91.44(V)
Number of Pixels	800(H)×3(RGB)×480(V)
Pixel Pitch (mm)	0.1905(H)×0.1905(V)
Color Pixel Arrangement	RGB vertical stripe
Display Mode	Normally white
Number of colors	16M
Viewing Direction	6 o'clock
Response Time (Tr+Tf)	20 ms
Brightness(cd/m ²)	500 nit(typ)
Viewing Angle(BL on, CR ≥ 10)	140 degree(H) · 120degree(V)
Electrical Interface(data)	TTL
Power consumption	1.72 W(typ.)
Outline Dimension(in mm)	163.8mm(H)×103.9mm(V)×6.05mm(D) (Typ.)
Weight(g)	150(typ)
BL unit	LED
Surface Treatment	Anti-Glare · Hardness:3H

2. ABSOLUTE MAXIMUM RATINGS

The following are maximum values which, if exceeded, may cause faulty operation or damage to the unit.

ITEM	SYMBOL	MIN.	MAX.	UNIT	NOTE
Digital Input Voltage	VCC	-0.3	5	V	
Analog Input Voltage	AVDD	-0.5	15	V	
Gate On Voltage	VGH	-0.3	40	V	
Gate Off Voltage	VGL	-20	0.3	V	
Gate On-Gate Off Voltage	VGH- VGL	-0.3	40	V	
Forward Current (per LED)	If	-	30	mA	
Reverse Voltage (per LED)	VR	-	5	V	
Pulse forward current (per LED)	Ifp	-	100	mA	【Note1】

【Note1】 :

Ifp Conditions : Pulse Width \leq 10msec ; Duty \leq 1/10

3. ELECTRICAL CHARACTERISTICS

3.1 TFT-LCD Power Voltage

Ta=25°C

ITEM	SYMBOL	MIN.	TYP.	MAX.	UNIT	NOTE
Digital Input Voltage	VCC	3.0	3.3	3.6	V	
Analog Input Voltage	AVDD	9.4	9.6	9.8	V	
Gate On Voltage	VGH	17	18	19	V	
Gate Off Voltage	VGL	-6.6	-6	-5.4	V	
Common Voltage	VCOM	3.8	3.9	4.0	V	【Note1】
Gamma Voltage	V1	-	9.178	-	V	
	V2	-	7.73	-	V	
	V3	-	7.25	-	V	
	V4	-	6.93	-	V	
	V5	-	5.82	-	V	
	V6	-	4.19	-	V	
	V7	-	2.75	-	V	
	V8	-	2.32	-	V	
	V9	-	1.78	-	V	
	V10	-	0.11	-	V	
Signal Input Voltage	VIH	0.7VCC	-	VCC	V	
	VIL	GND	-	0.3VCC	V	

【Note1】 Please adjust VCOM to make the flicker level be minimum.

3.2 TFT-LCD Current Consumption

ITEM	SYMBOL	CONDITION	MIN.	TYP.	MAX.	UNIT	NOTE
Gate on Current	IVGH	VGH = 18V	-	0.5	1	mA	【Note1】
Gate off Current	IVGL	VGL = -6V	-	0.5	1	mA	【Note1】
Digital Current	IVCC	VCC = 3.3V	-	10	15	mA	【Note1】
Analog Current	IAVDD	AVDD = 9.6V	-	30	35	mA	【Note1】
Total Power Consumption	PC		-	333	409.5	mW	【Note1】

【Note1】

Typical: Under 64 gray pattern

Maximum: Under black pattern



(a) 64 Gray Pattern

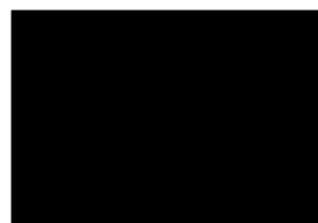

(b) Black Pattern

3.3 Power · Signal sequence

Power On : VCC→AVDD/VGL→VGH→DATA

Power Off : DATA→VGH→AVDD/VGL→VCC

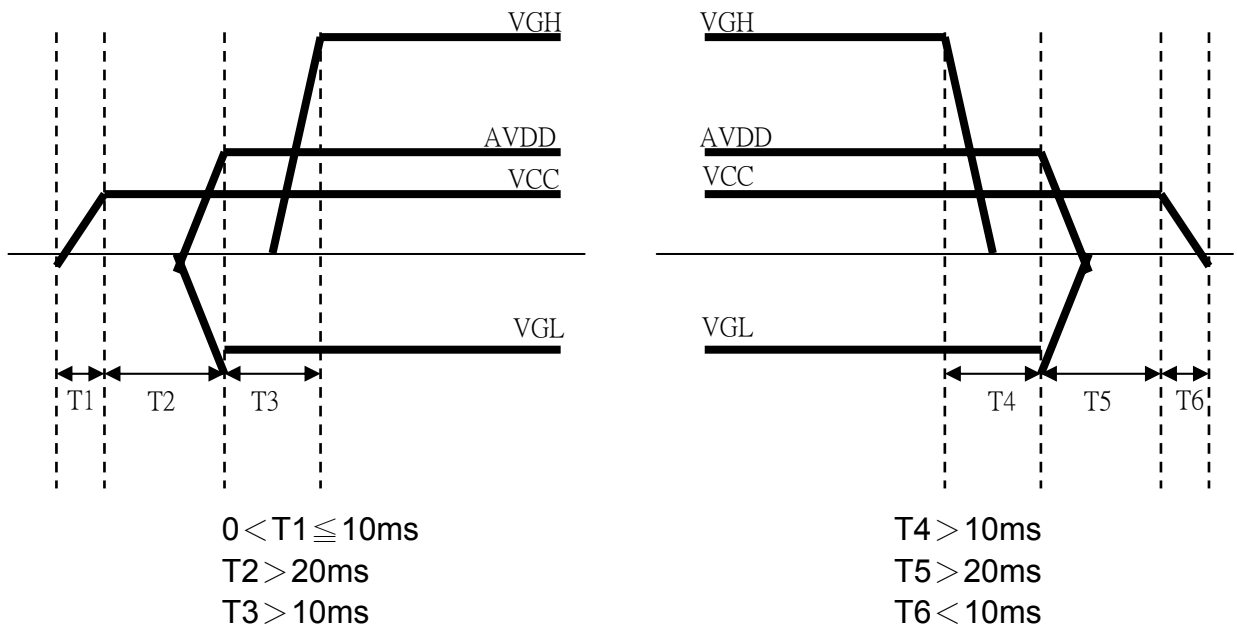

3.4 Back Light

Ta=25°C

ITEM	SYMBOL	MIN.	TYP.	MAX.	UNIT	NOTE
LED current	IL	--	140	--	mA	
LED voltage	VL	8.7	9.9	10.8	V	
Power consumption	WL	--	1.386	--	W	
Lifetime	-	10000			Hr	

【NOTE】 :

- *1) LED Circuit Diagram.
- *2) A : Anode(+), K : Cathode(-)
- *3) LED control suggested fixed current.
- *4) The LED supply voltage is defined by the number of LED at Ta=25°C and IL=20 mA.
- *5) Definition of LED lifetime : Luminance < 50% initial value.

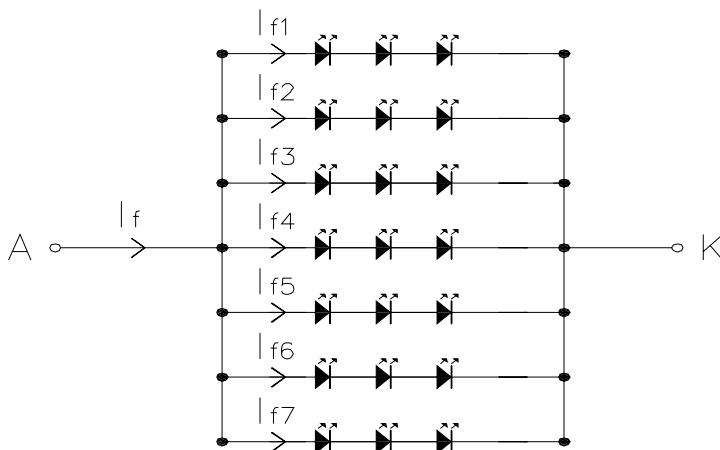

4. INTERFACE CONNECTION

4.1 CN1

Pin NO.	SYMBOL	DESCRIPTION
1	AGND	Analog Ground
2	AVDD	Analog Power
3	VCC	Digital Power
4	R0	Data Input(LSB)
5	R1	Data Input
6	R2	Data Input
7	R3	Data Input
8	R4	Data Input
9	R5	Data Input
10	R6	Data Input
11	R7	Data Input(MSB)
12	G0	Data Input(LSB)
13	G1	Data Input
14	G2	Data Input
15	G3	Data Input
16	G4	Data Input
17	G5	Data Input
18	G6	Data Input
19	G7	Data Input(MSB)
20	B0	Data Input(LSB)
21	B1	Data Input
22	B2	Data Input
23	B3	Data Input
24	B4	Data Input
25	B5	Data Input
26	B6	Data Input
27	B7	Data Input(MSB)
28	DCLK	Clock input
29	DE	Data Enable signal
30	HSD	Horizontal sync input. Negative polarity
31	VSD	Vertical sync input. Negative polarity
32	MODE	DE/SYNC mode select. Normally pull high H: DE mode. L: HSD/VSD mode
33	RSTB	Global reset pin. Active low to enter reset state. Suggest to connecting with an RC reset circuit for stability. Normally pull high. (R=47KΩ · C=1μ)
34	STBY	Standby mode, normally pull high STBYB="1", normal operation STBYB="0", timing control, source driver will turn off, all output are high-Z
35	SHLR	Left or Right Display Control
36	VCC	Digital Power
37	UPDN	Up / Down Display Control
38	GND	Digital Ground
39	AGND	Analog Ground
40	AVDD	Analog Power
41	VCOM	Common Voltage
42	NC	Not connect
43	NC	Not connect
44	NC	Not connect
45	V10	Gamma correction voltage reference

46	V9	Gamma correction voltage reference
47	V8	Gamma correction voltage reference
48	V7	Gamma correction voltage reference
49	V6	Gamma correction voltage reference
50	V5	Gamma correction voltage reference
51	V4	Gamma correction voltage reference
52	V3	Gamma correction voltage reference
53	V2	Gamma correction voltage reference
54	V1	Gamma correction voltage reference
55	NC	Not connect
56	VGH	Positive Power for TFT
57	VCC	Digital Power
58	VGL	Negative Power for TFT
59	GND	Digital Ground
60	NC	Not connect

【NOTE】 :

- 1) GND Pin must connection to ground.
- 2) UPDN and SHLR control Function

UPDN	SHLR	FUNCTION
0	1	Normal display
0	0	Select left or right
1	1	Shift up or down control
1	0	Select left or right Shift up or down control

4.2 CN2 (LED backlight)

Pin No.	SYMBOL	FUNCTION	NOTE
1	+	Power input-side positive	BLACK
2	-	Power input-side negative	WHITE

【Notes】

Note 1 : Backlight side connector : BHSR-02VS-1 (JST)

Note 2 : Mating connector : SM02B-BHSS-1 (JST)

5. INPUT SIGNAL

5.1 Timing Specification

	ITEM	SYMBOL	MIN.	TYP.	MAX.	UNIT	Note
DCLK	Dot Clock	1/tCLK	25	27	32	MHz	
	DCLK pulse duty	Tcwh	40	50	60	%	
DE	Setup Time	Tesu	8	-	-	ns	
	Hold time	Tehd	8	-	-	ns	
	Horizontal Period	tH	908	928	948	tCLK	
	Horizontal Valid	tHA	800			tCLK	
	Horizontal Blank	tHB	108	128	148	tCLK	
	Vertical Period	tV	515	525	535	tH	
	Vertical Valid	tVA	480			tH	
	Vertical Blank	tVB	35	45	55	tH	
	SYNC	HSYNC Setup Time	Thst	8	-	-	ns
HSYNC Hold Time		Thhd	8	-	-	ns	
VSYNC Setup Time		Tvst	8	-	-	ns	
VSYNC Hold Time		Tvhd	8	-	-	ns	
Horizontal Period		th	908	928	948	tCLK	
Horizontal Pulse Width		thpw	-	48	-	tCLK	thb + thpw=88DCLK is fixed
Horizontal Back Porch		thb	-	40	-	tCLK	
Horizontal Front Porch		thfp	20	40	60	tCLK	
Horizontal Valid		thd	800			tCLK	
Vertical Period		tv	515	525	535	th	
Vertical Pulse Width		tvpw	-	3	-	th	tvpw + tvb = 32th is fixed
Vertical Back Porch		tvb	-	29	-	th	
Vertical Front Porch		tvfp	3	13	23	th	
Vertical Valid		tvd	480			th	
DATA	Setup Time	Tdsu	8	-	-	ns	
	Hold Time	Tdhd	8	-	-	ns	

5.2 Timing sequence(Timing chart)

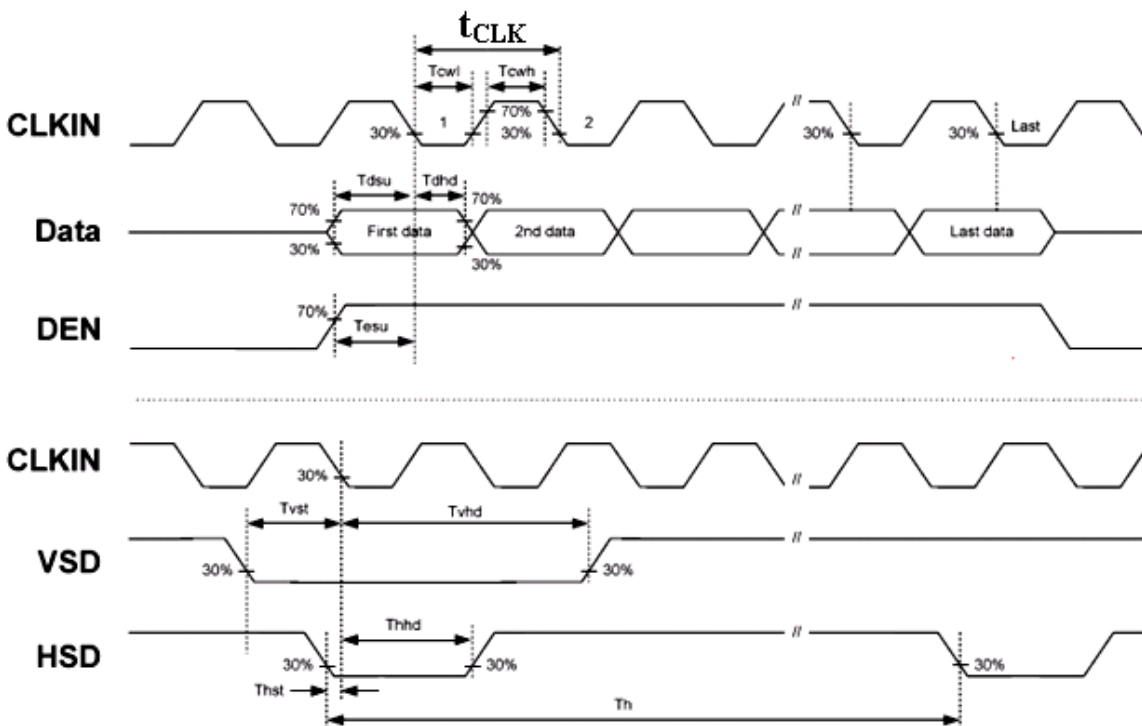

5.2.1 DE mode Horizontal Timing Sequence

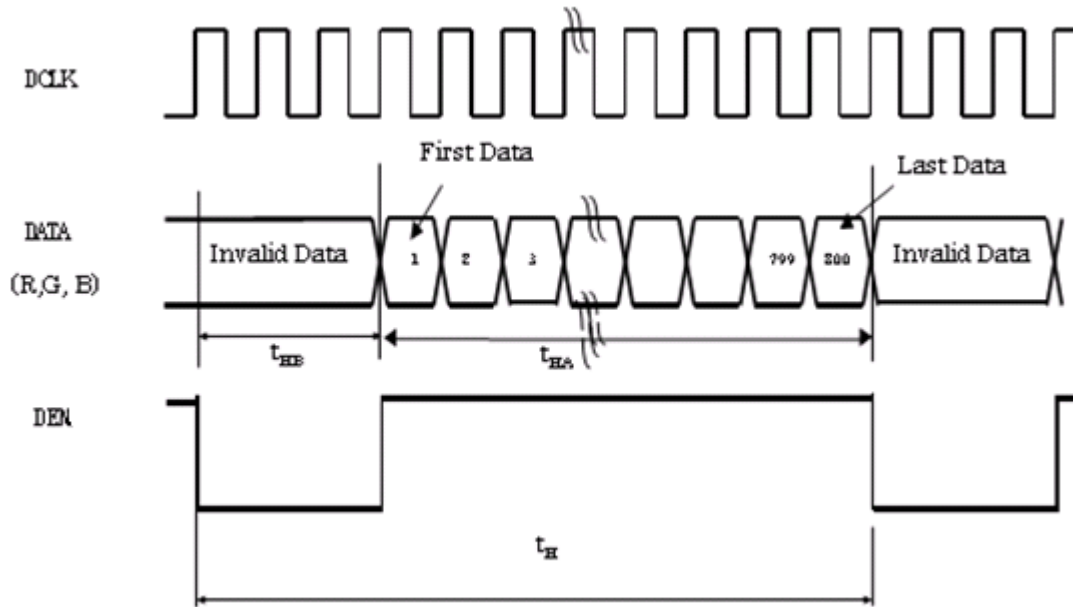

5.2.2 DE mode Vertical Timing Sequence

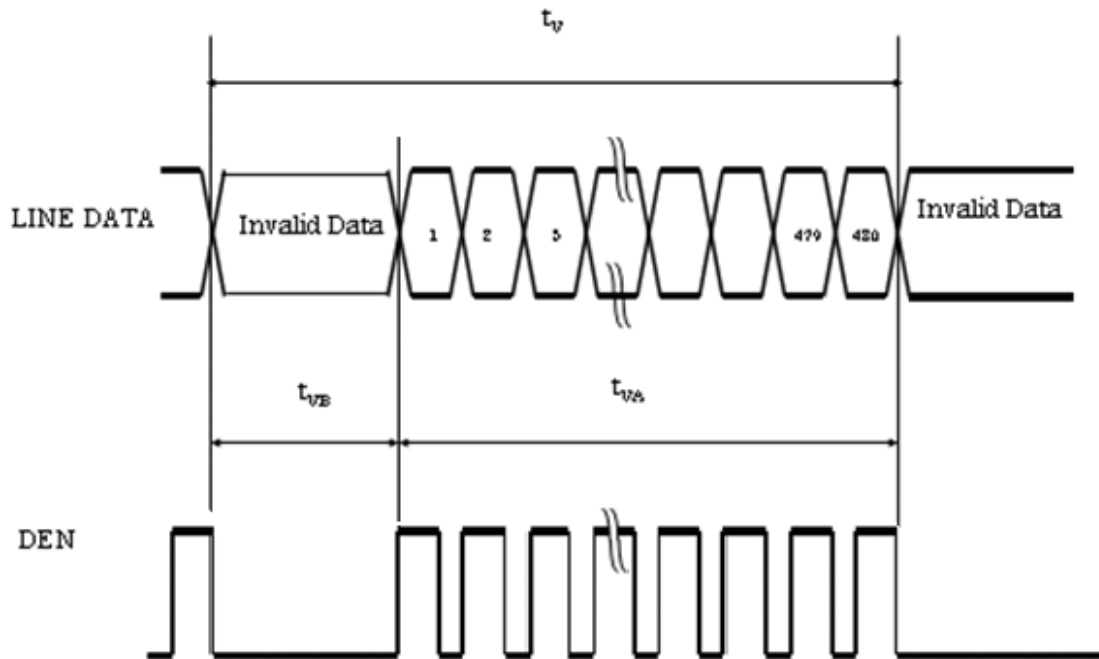

5.2.3 SYNC mode Horizontal Timing Sequence

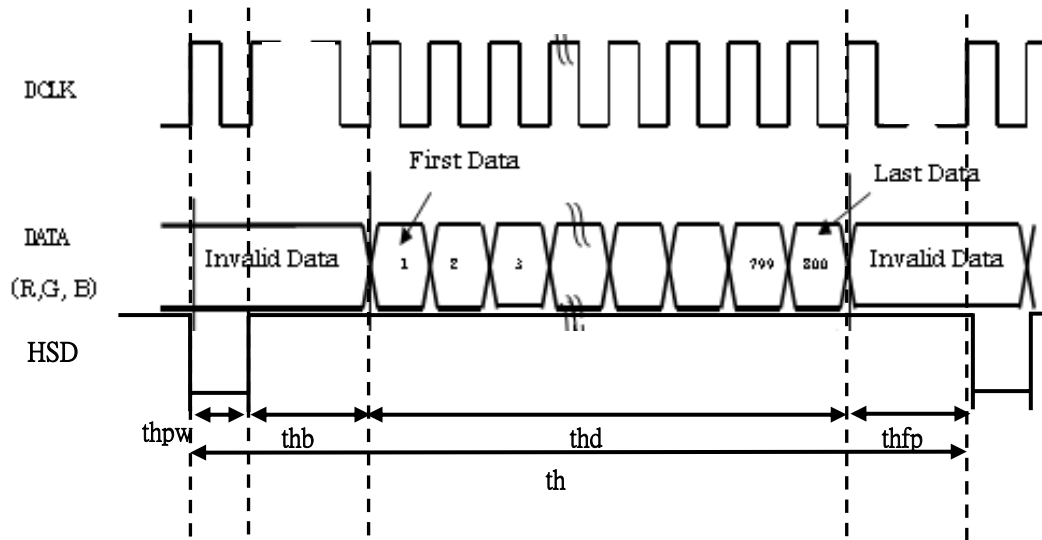

5.2.4 SYNC mode Vertical Timing Sequence

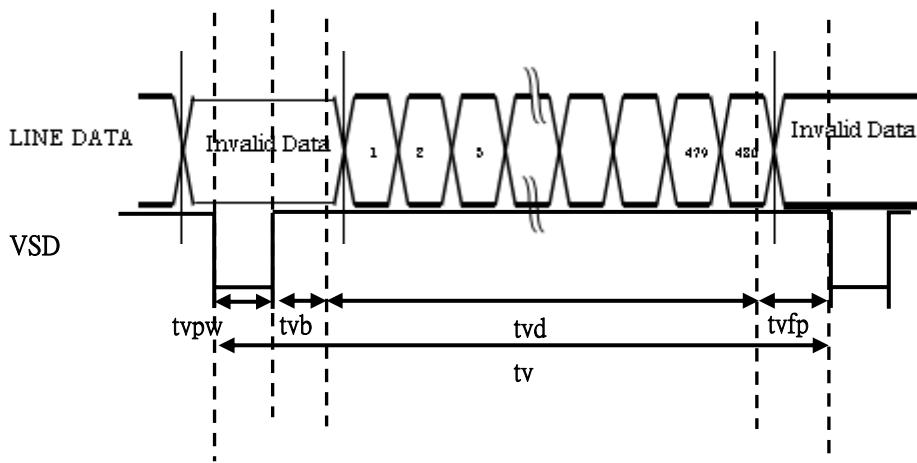

6. MECHANICAL DIMENSION

6.1 Front Side

[Unit : mm]

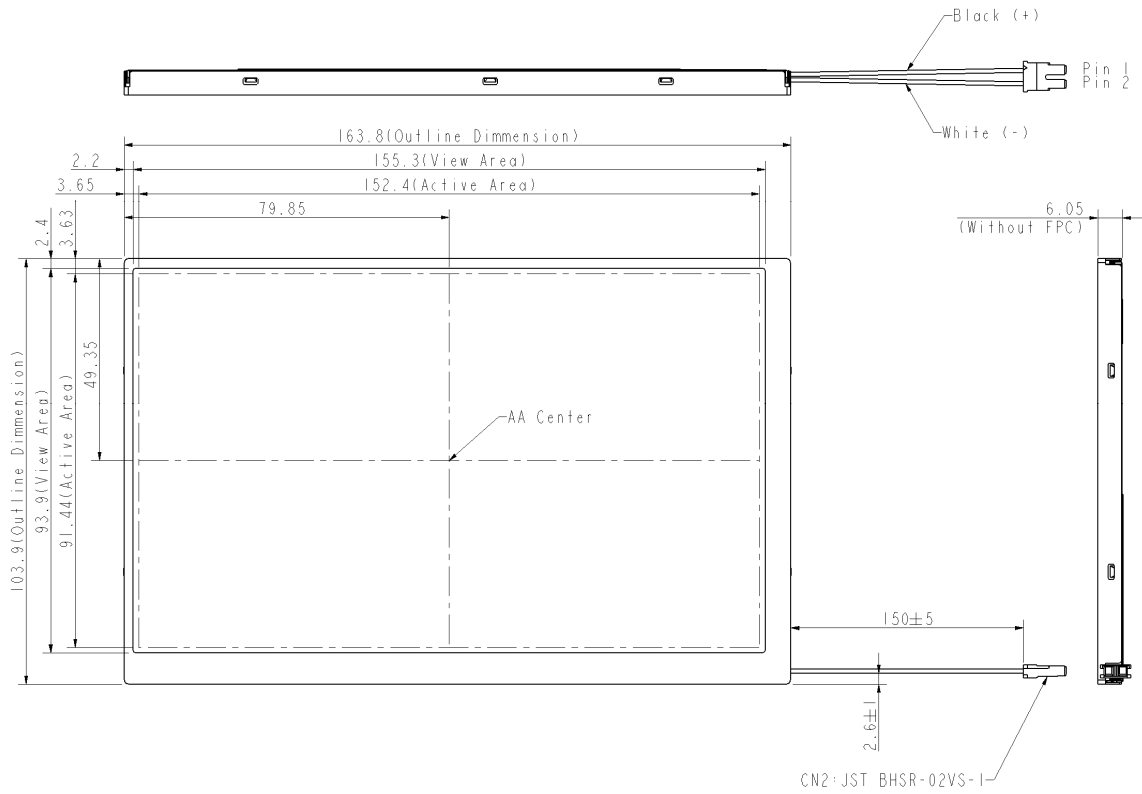

6.2 Rear Side

[Unit : mm]

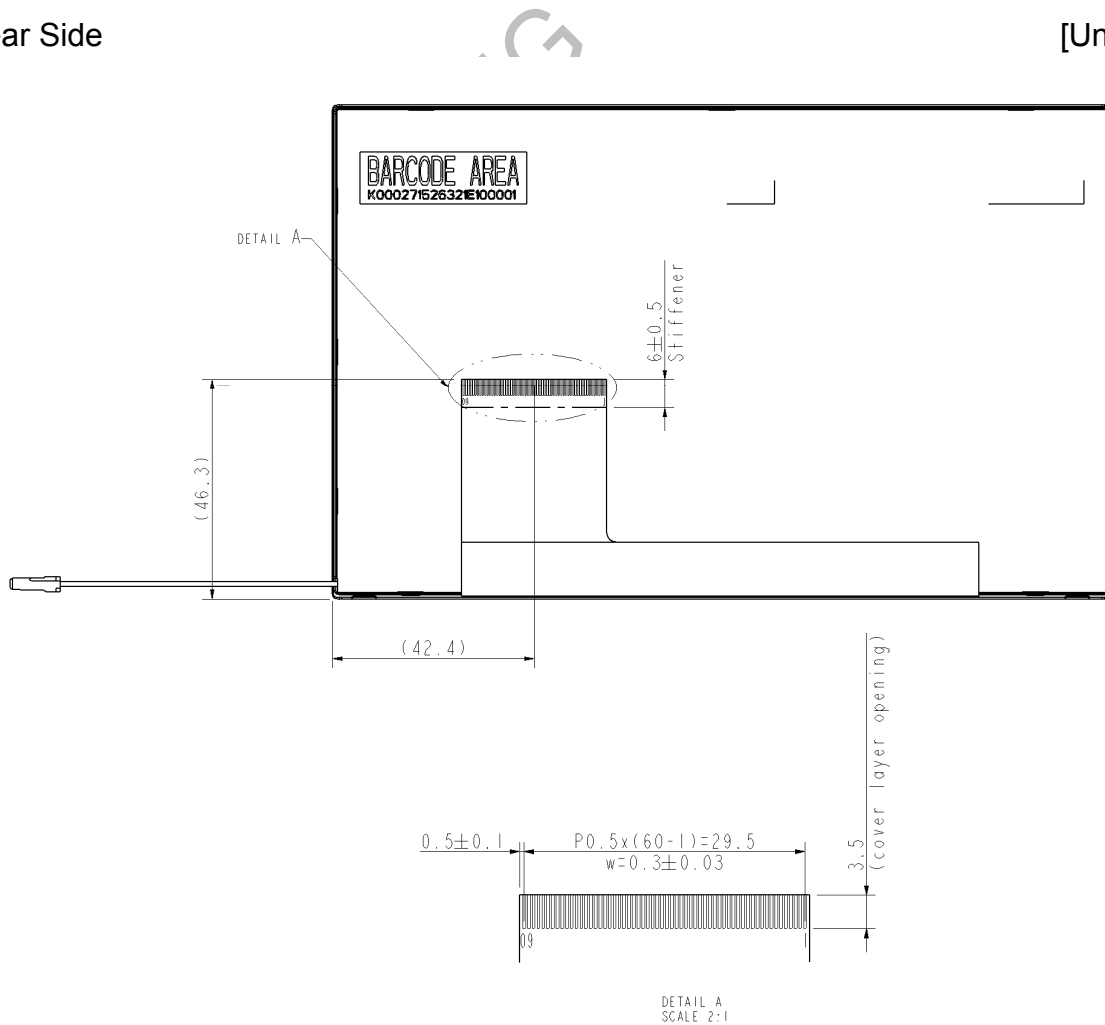

[Note] : Tolerance is ± 0.3mm unless noted

7. OPTICAL CHARACTERISTICS

Ta=25°C

ITEM	SYMBOL	CONDITION	MIN.	TYP.	MAX.	UNIT	NOTE	
Constrast Ratio	CR	Point-5	350	450	--	--	*1)*2)*3)	
Luminance*)	Lw	Point-5	400	500	--	cd/m ²	*1)*3)	
Luminance Uniformity	ΔL		70	80	--	%	*1)*3)	
Response Time (White - Black)	Tr + Tf	Point-5	--	20	35	ms	*1)*3)*5)	
Viewing Angle	Horizontal	ψ	CR ≥ 10 Point-5	120	140	--	°	*1)*2)*4)
	Vertical	θ		100	120	--	°	*1)*2)*4)
Color Coordinate	White	Wx Wy	Point-5	0.273 0.289	0.313 0.329	0.353 0.369	--	*1)*3)
	Red	Rx Ry		0.539 0.298	0.5737 0.3339	0.599 0.358		
	Green	Gx Gy		0.319 0.533	0.3484 0.571	0.379 0.593		
	Blue	Bx By		0.124 0.067	0.1583 0.1128	0.184 0.127		

NOTE:

*1) Measure condition: 25°C±2°C, 60±10%RH, under10 Lux in the dark room. BM-5A (TOPCON), view angle 2°, IL=140mA (Backlight current) , measure the panel after turning on 10 minutes .

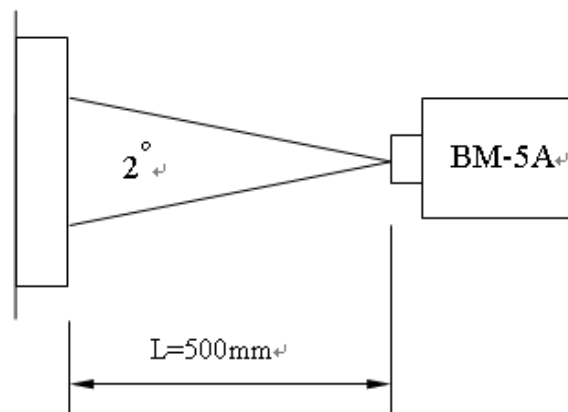

*2) Definition of contrast ratio : (in the dark room.BM-5A (TOPCON))
 Contrast Ratio (CR) = (White) Luminance of ON ÷ (Black) Luminance of OFF

*3) Definition of luminance : (in the dark room.BM-5A (TOPCON))

Measure white luminance on the point 5 as figure7-1

Definition of Luminance Uniformity:

Measure white luminance on the point1~9 as figure7-1

$$\Delta L = [L(\text{MIN})/L(\text{MAX})] \times 100\%$$

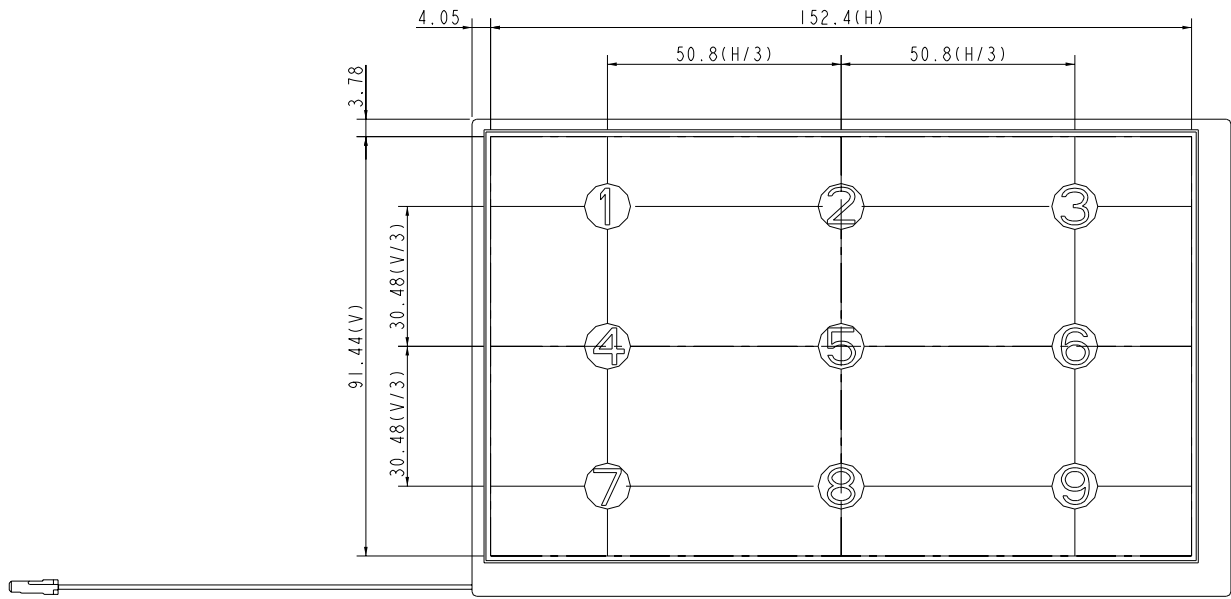

Fig7-1 Measuring

point

*4) Definition of Viewing Angle(θ, ψ), refer to Fig7-2 as below : (in the dark room.EZ-CONTRAST (ELDIM))

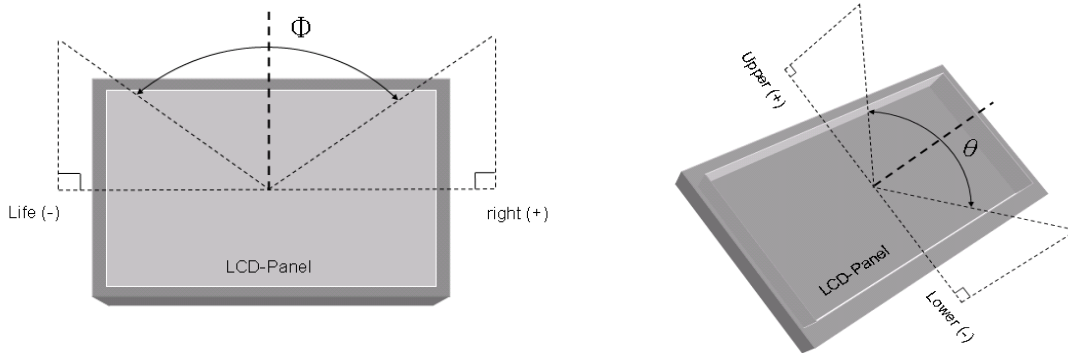

Fig7-2 Definition of Viewing Angle

*5) Definition of Response Time (White-Black)

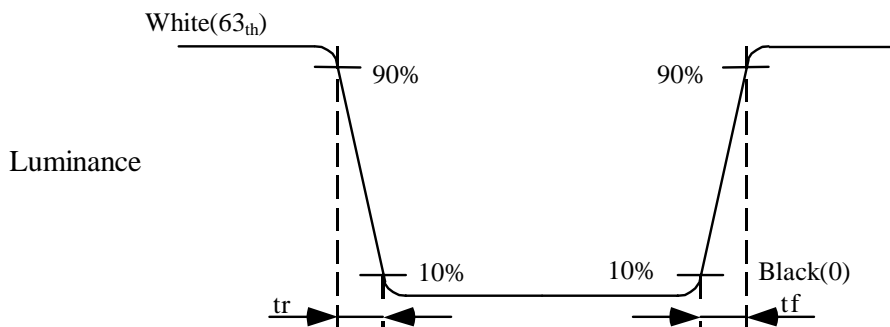

Fig7-3 Definition of Response Time (White-Black)

8. RELIABILITY TEST

8.1. Temperature and humidity

TEST ITEMS	CONDITIONS	REMARK
High Temperature Operation	85°C , 240Hrs	
High Temperature Storage	95°C , 240Hrs	
High Temperature High Humidity Operation	60°C , 90%RH , 240Hrs	No condensation
Low Temperature Operation	-30°C , 240Hrs	
Low Temperature Storage	-40°C , 240Hrs	
Thermal Shock	-30°C (0.5Hr) ~ 85°C(0.5Hr) 200 cycles	

8.2. Shock and Vibration

TEST ITEMS	CONDITIONS
Shock (Non-operation)	<ul style="list-style-type: none"> ● Shock level:980m/s²(equal to 100G) ● Waveform:half sinusoidal wave,6ms. ● Number of shocks:one shock input in each direction of three mutually perpendicular axes for a total of three shock inputs.
Vibration (Non-operation)	<ul style="list-style-type: none"> ● Frequency range:8~33.3Hz ● Stroke:1.3mm ● Vibration:sinusodial wave,perpendicularaxis(both x, z axis:2Hrs, y axis 4Hrs). ● Sweep:2.9G,33.3Hz-400Hz ● Cycle:15min

8.3 Judgment standard

The Judgment of the above test should be made as follow:

Pass:Normal display image with no obvious non-uniformity and no line defect.Partial transformation of the module parts should be ignored.

Fail:No display image,obvious non-uniformity,or line defect.