



Chunghwa Picture Tubes, Ltd. Product Specification

To :

Date : 2008/08/11

TFT LCD

CLAA070LC0BCW

ACCEPTED BY : (V0.1)

APPROVED BY	CHECKED BY	PREPARED BY

Prepared by :

Product Planning Management Division
Small & Medium TFT Product Business Unit
CHUNGHWA PICTURE TUBES, LTD.

1127 Hopin Rd., Padeh, Taoyuan, Taiwan 334, R.O.C.
TEL: +886-3-3675151 FAX: +886-3-377-3858

Doc.No: SPEC_CLAA070LC0BCW_V0.1_080811

Issue Date:

2007/05/04

REVISION STATUS

Revision Notice	Description	Page	Rev. Date
V0.0	First revision (Tentative)		2007/04/17
V0.1	Revise MIN Luminance Revise Color Coordinate	16	2007/05/04

CONTENTS

1. OVERVIEW	4
2. ABSOLUTE MAXIMUM RATINGS	5
3. ELECTRICAL CHARACTERISTICS.....	6
3.1 TFT LCD	6
3.2 TFT-LCD Current Consumption.....	7
3.3 Power 、 Signal sequence.....	7
4. INTERFACE CONNECTION.....	8
4.1 CN1.....	8
5. INPUT SIGNAL(DE ONLY MODE)	10
5.1 Timing Specification.....	10
5.2 Timing sequence(Timing chart)	10
5.3 LVDS Input Data mapping	11
5.4 Color Data Assignment.....	12
6. BLOCK DIAGRAM.....	13
7. MECHANICAL DIMENSION	14
7.1 Front Side	14
7.2 Rear Side.....	15
8. OPTICAL CHARACTERISTICS.....	16
9. RELIABILITY TEST	19
9.1. Temperature and humidity.....	19
9.2. Shock and Vibration.....	19
9.3. ESD Test	19
9.4 Judgment standard	19

1. OVERVIEW

CLAA070LC0BCW is 17.67cm (7") color TFT-LCD(Thin Film Transistor Liquid Crystal Display) module. Composed of LCD panel,driver ICs,control circuit,and LED backlight.

The 7.0"screen produces a high resolution image that is composed of 800×480 pixel elements in a stripe arrangement.Display 262K colors by 6 Bit R.G.B signal input. The LCD is drivered by a single input voltage (3.3 V) . The LED backlight is drivered by 5 V input voltage.

General specifications are summarized in the following table :

ITEM	SPECIFICATION
Display Area (mm)	152.4(W)×91.44(H)
Number of Pixels	800(H)×3(RGB)×480(V)
Pixel Pitch (mm)	0.1905(H)×0.1905(V)
Color Pixel Arrangement	RGB vertical stripe
Display Mode	Normally white
Number of colors	262,144
Viewing Direction	6 o'clock
Response Time (Tr+Tf)	20ms
Brightness(cd/m ²)	220nit(typ)
Viewing Angle(BL on,CR≥10)	140 degree(H) · 110degree(V)
Electrical Interface(data)	LVDS
Power consumption	2.0W(Typ)
Outline Dimension(in mm)	165(W)×104(H)×5(D)
Weight(g)	TBD
BL unit	LED
Surface Treatment	Anti-Glare · Hardness:3H

2. ABSOLUTE MAXIMUM RATINGS

Item	Symbol	Min.	Max.	Unit	Note
Input Voltage	Vcc	-0.3	4.0	V	
Signal Input Voltage	RxIN0+ ~ RxIN2+ RxIN0- ~ RxIN2- Rx CLK IN +/-	-0.3	Vcc+0.3	V	
Static Electricity	VESDc	-200	+200	V	【Note1】
	VESDm	-15K	+15K	V	
ICC Rush Current	IRUSH	-	1	A	【Note2】

【Note1】

Test Condition: IEC 61000-4-2 ,
 VESDc : Contact discharge to input connector
 VESDm : Discontact discharge to module

【Note2】

Control signal: High(+3.3V)→Low(GND)
 Supply Voltage of rising time should be from R3 and C2 tune to 550 us.

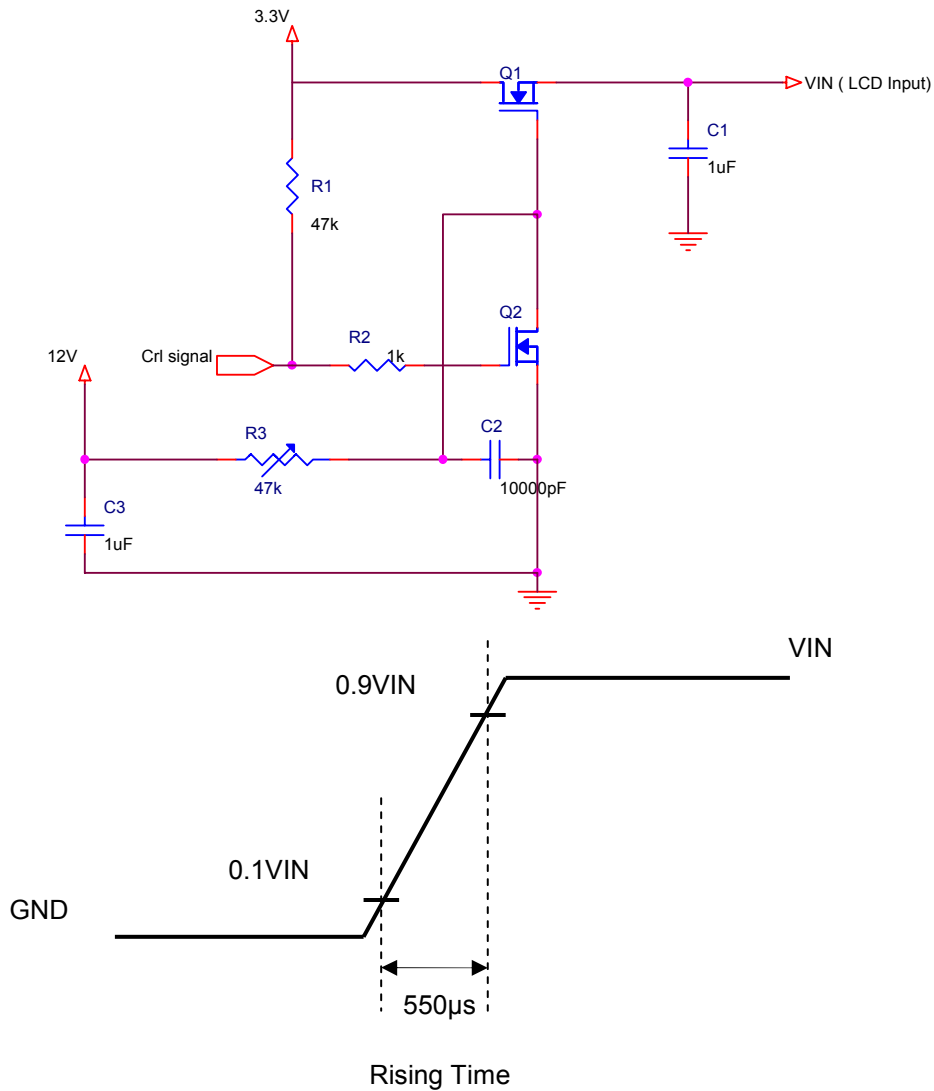

3. ELECTRICAL CHARACTERISTICS

3.1 TFT LCD

Ta=25°C

Item	Symbol	Min.	Typ	Max.	Unit	Note	
Power Supply Voltage For LCD	VCC	3.0	3.3	3.6	V	【Note1】	
Power Supply Voltage For LED	VLED	4.5	5	5.5	V		
Logic Input Voltage (LVDS:IN+,IN-)	Input Voltage	VIN	0	-	VCC	【Note2】	
	Common Mode Voltage	VCM	1.08	1.2	1.32	V	【Note2】
	Differential Input Voltage	VID	250	350	450	mV	【Note2】
	Threshold Voltage(high)	VTH	-	-	100	mV	【Note2】 When VCM=+1.2V
	Threshold Voltage(low)	VTL	-100	-	-	mV	【Note2】
ADJ Input Voltage	Threshold Voltage(high)	VIH		3.3	V		
	Threshold Voltage(low)	VIL	GND	0.3	V		

Remarks :

【Note1】

VCC –dip condition:

- 1) When $2.7\text{ V} \leq VCC < 3.0\text{ V}$, $td \leq 10\text{ ms}$.
- 2) $VCC > 3.0\text{ V}$, VCC-dip condition should be same as VCC-turn-on condition.

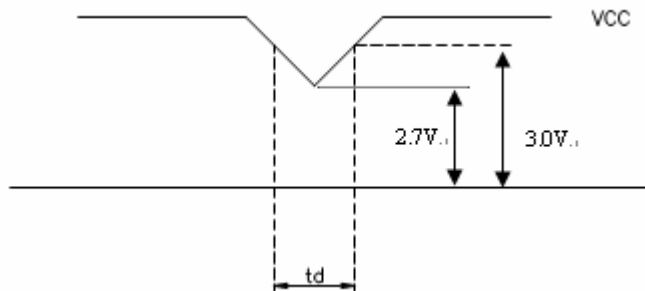

【Note2】 LVDS signal

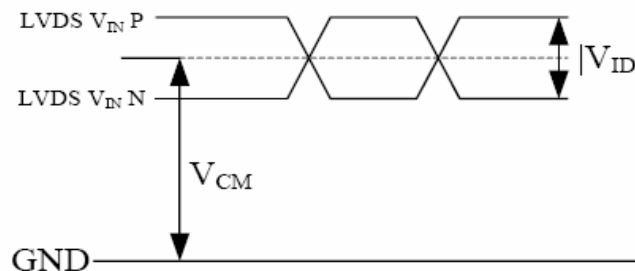

$|VID| = |VTH - VTL|,$
 $VCM = (VTH + VTL)/2$

3.2 TFT-LCD Current Consumption

Item	Symbol	Min	Type	Max	Unit	Notes
LCD power current	ICC	--	150	200	mA	【Note1】
LED power current	ILED		300	350	mA	【Note2】

【Note1】

Typical: Under 64 gray pattern
 Maximum: Under black pattern



(a) 64 Gray Pattern



(b) Black Pattern

【Note2】

Typical: When VDD is 5V
 Maximum: When VDD is 4.5V

3.3 Power · Signal sequence

- $t1 \leq 10ms$ $1 \text{ sec} \leq t5$
- $50ms \leq t2$ $200ms \leq t6$
- $0 < t3 \leq 50ms$ $200ms \leq t7$
- $0 < t4 \leq 10ms$

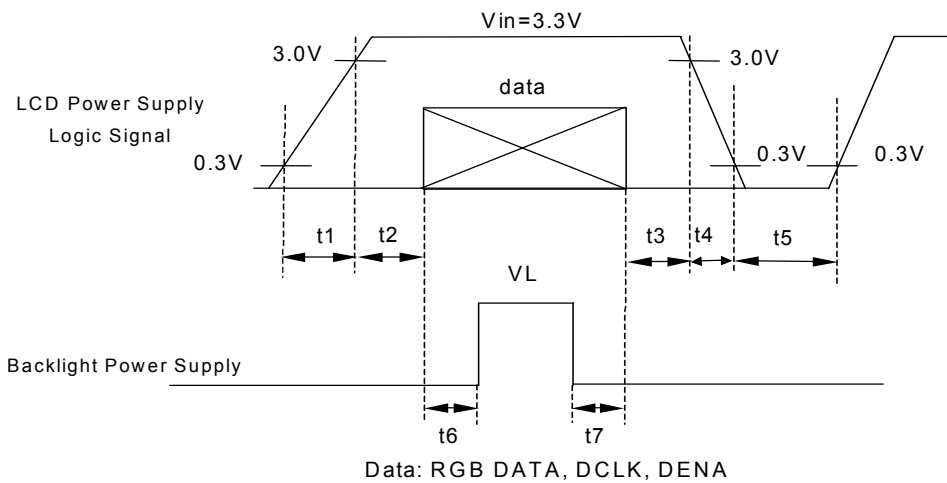

4. INTERFACE CONNECTION

4.1 CN1 : Connector type : STARCONN 093F30-B0B01A

Pin NO.	SYMBOL	DESCRIPTION
1	AVSS	Power Ground
2	VCC	Power Supply for Digital circuit
3	VCC	Power Supply for Digital circuit
4	NC	NC
5	ADJ	Brightness control for LED B/L
6	NC	NC
7	AVSS	Power Ground
8	RXIN0-	Negative LVDS differential data inputs
9	RXIN0+	Positive LVDS differential data inputs
10	AVSS	Power Ground
11	RXIN1-	Negative LVDS differential data inputs
12	RXIN1+	Positive LVDS differential data inputs
13	AVSS	Power Ground
14	RXIN2-	Negative LVDS differential data inputs
15	RXIN2+	Positive LVDS differential data inputs
16	AVSS	Power Ground
17	RXCLK-	Negative LVDS differential clock inputs
18	RXCLK+	Positive LVDS differential clock inputs
19	AVSS	Power Ground
20	NC	NC
21	NC	NC
22	AVSS	Power Ground
23	NC	NC
24	VLED	Power Supply for LED Driver circuit
25	VLED	Power Supply for LED Driver circuit
26	VLED	Power Supply for LED Driver circuit
27	NC	NC
28	AVSS	Power Ground
29	NC	NC
30	NC	NC

Remarks:

1).ADJ adjust brightness to control Pin , Pulse duty the more big the more bright

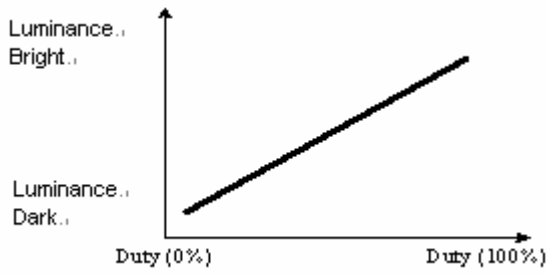

2) ADJ signal=0~3.3V , operation frequency : 20±5KHz

F = 20KHz , T = 0.05ms

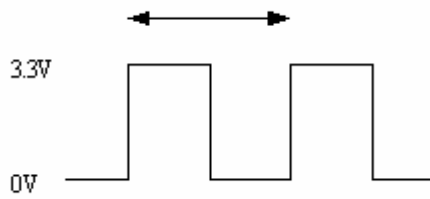

3) AVSS Pin must ground contact , can not be floating.

5. INPUT SIGNAL(DE ONLY MODE)

5.1 Timing Specification

Item		Symbol	Min	Typ	Max	Unit	
CLK Frequency		fCLKin	25	27	32	MHz	
DENA	Horizontal	Horizontal total Time	t _H	850	900	950	tCLK
		Horizontal effective Time	t _{HA}	800	800	800	tCLK
		Horizontal Blank Time	t _{HB}	50	100	150	tCLK
	Vertical	Frame	fV	55	60	65	Hz
		Vertical total Time	t _V	490	500	520	t _H
		Vertical effectiveTime	t _{VA}	480	480	480	t _H
		Vertical Blank Time	t _{VB}	10	20	40	t _H

5.2 Timing sequence(Timing chart)

5.2.1 Horizontal Timing Sequence

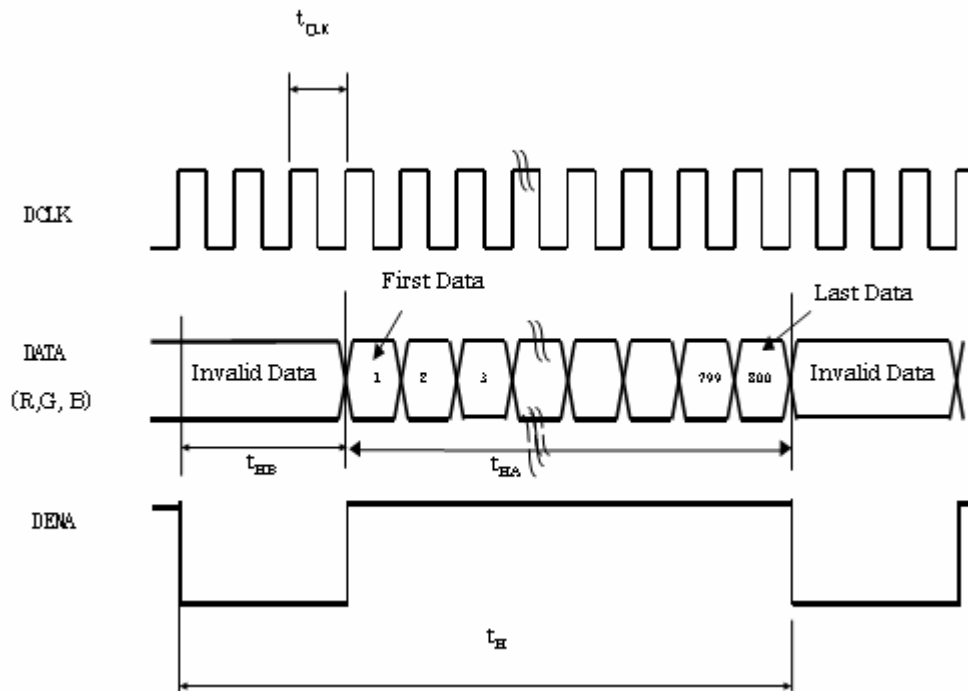

5.2.2 Vertical Timing Sequence

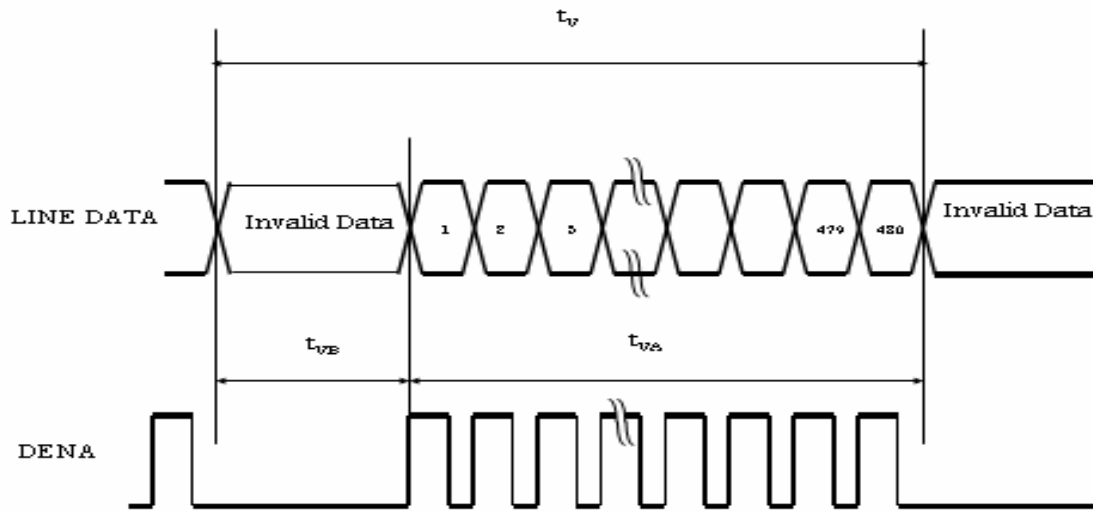

5.3 LVDS Input Data mapping

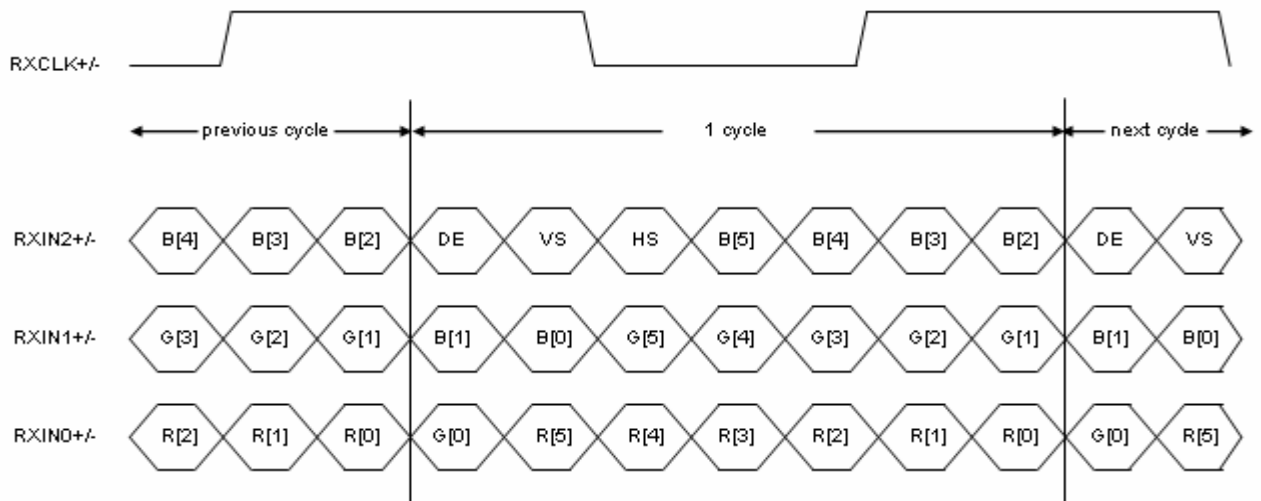

5.4 Color Data Assignment

COLOR	INPUT	R DATA						G DATA						B DATA					
		DATA	R5	R4	R3	R2	R1	R0	G5	G4	G3	G2	G1	G0	B5	B4	B3	B2	B1
		MSB					LSB	MSB					LSB	MSB					LSB
	BLACK	0	0	0	0	0	0	0	0	0	0	0	0	0	0	0	0	0	0
	RED(63)	1	1	1	1	1	1	0	0	0	0	0	0	0	0	0	0	0	0
BASIC	GREEN(63)	0	0	0	0	0	0	1	1	1	1	1	1	0	0	0	0	0	0
COLOR	BLUE(63)	0	0	0	0	0	0	0	0	0	0	0	0	1	1	1	1	1	1
	CYAN	0	0	0	0	0	0	1	1	1	1	1	1	1	1	1	1	1	1
	MAGENTA	1	1	1	1	1	1	0	0	0	0	0	0	1	1	1	1	1	1
	YELLOW	1	1	1	1	1	1	1	1	1	1	1	1	0	0	0	0	0	0
	WHITE	1	1	1	1	1	1	1	1	1	1	1	1	1	1	1	1	1	1
	RED(0)	0	0	0	0	0	0	0	0	0	0	0	0	0	0	0	0	0	0
	RED(1)	0	0	0	0	0	1	0	0	0	0	0	0	0	0	0	0	0	0
	RED(2)	0	0	0	0	1	0	0	0	0	0	0	0	0	0	0	0	0	0
RED																			
	RED(62)	1	1	1	1	1	0	0	0	0	0	0	0	0	0	0	0	0	0
	RED(63)	1	1	1	1	1	1	0	0	0	0	0	0	0	0	0	0	0	0
	GREEN(0)	0	0	0	0	0	0	0	0	0	0	0	0	0	0	0	0	0	0
	GREEN(1)	0	0	0	0	0	0	0	0	0	0	0	1	0	0	0	0	0	0
	GREEN(2)	0	0	0	0	0	0	0	0	0	0	1	0	0	0	0	0	0	0
GREEN																			
	GREEN(62)	0	0	0	0	0	0	1	1	1	1	1	0	0	0	0	0	0	0
	GREEN(63)	0	0	0	0	0	0	1	1	1	1	1	1	0	0	0	0	0	0
	BLUE(0)	0	0	0	0	0	0	0	0	0	0	0	0	0	0	0	0	0	0
	BLUE(1)	0	0	0	0	0	0	0	0	0	0	0	0	0	0	0	0	0	1
	BLUE(2)	0	0	0	0	0	0	0	0	0	0	0	0	0	0	0	0	1	0
BLUE																			
	BLUE(62)	0	0	0	0	0	0	0	0	0	0	0	0	1	1	1	1	1	0
	BLUE(63)	0	0	0	0	0	0	0	0	0	0	0	0	1	1	1	1	1	1

Remarks:

(1)Definition of Gray Scale

color(n) : n is series of Gray Scale

The more n value is, the bright Gray Scale.

(2)Data:1-High,0-Low

5.2.2 Vertical Timing Sequence

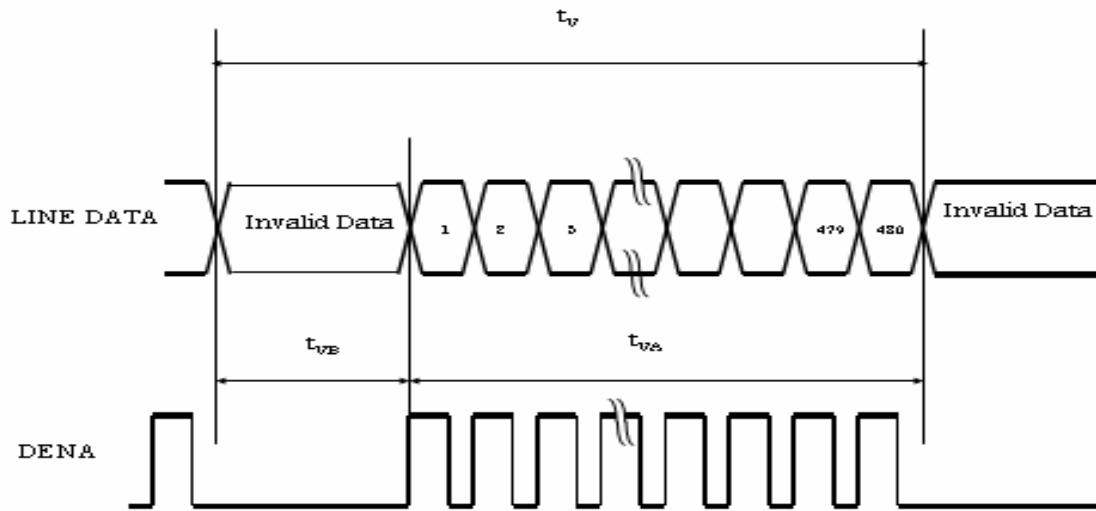

5.3 LVDS Input Data mapping

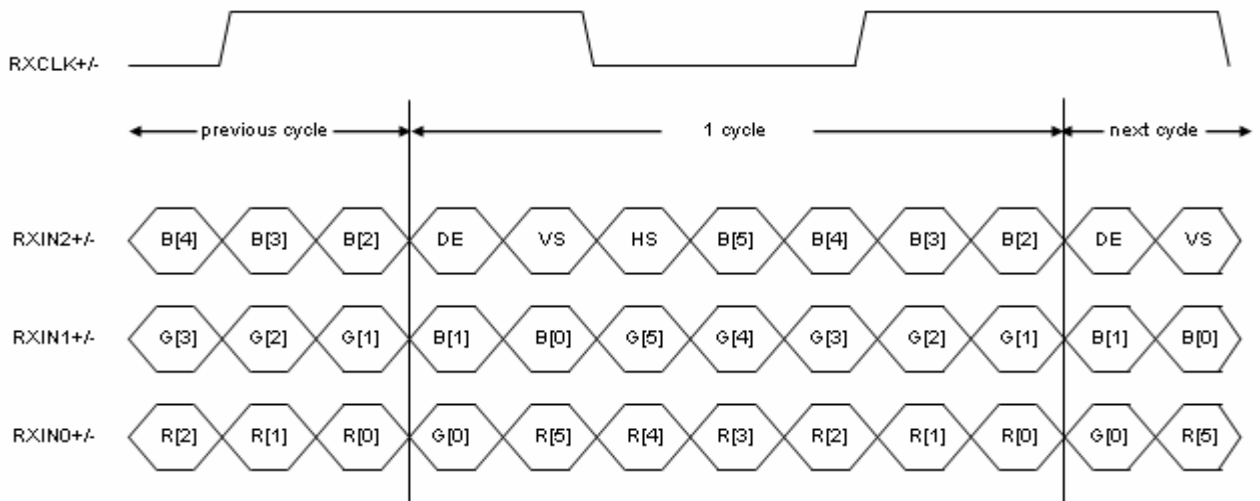

7. MECHANICAL DIMENSION

7.1 Front Side

[Unit : mm]

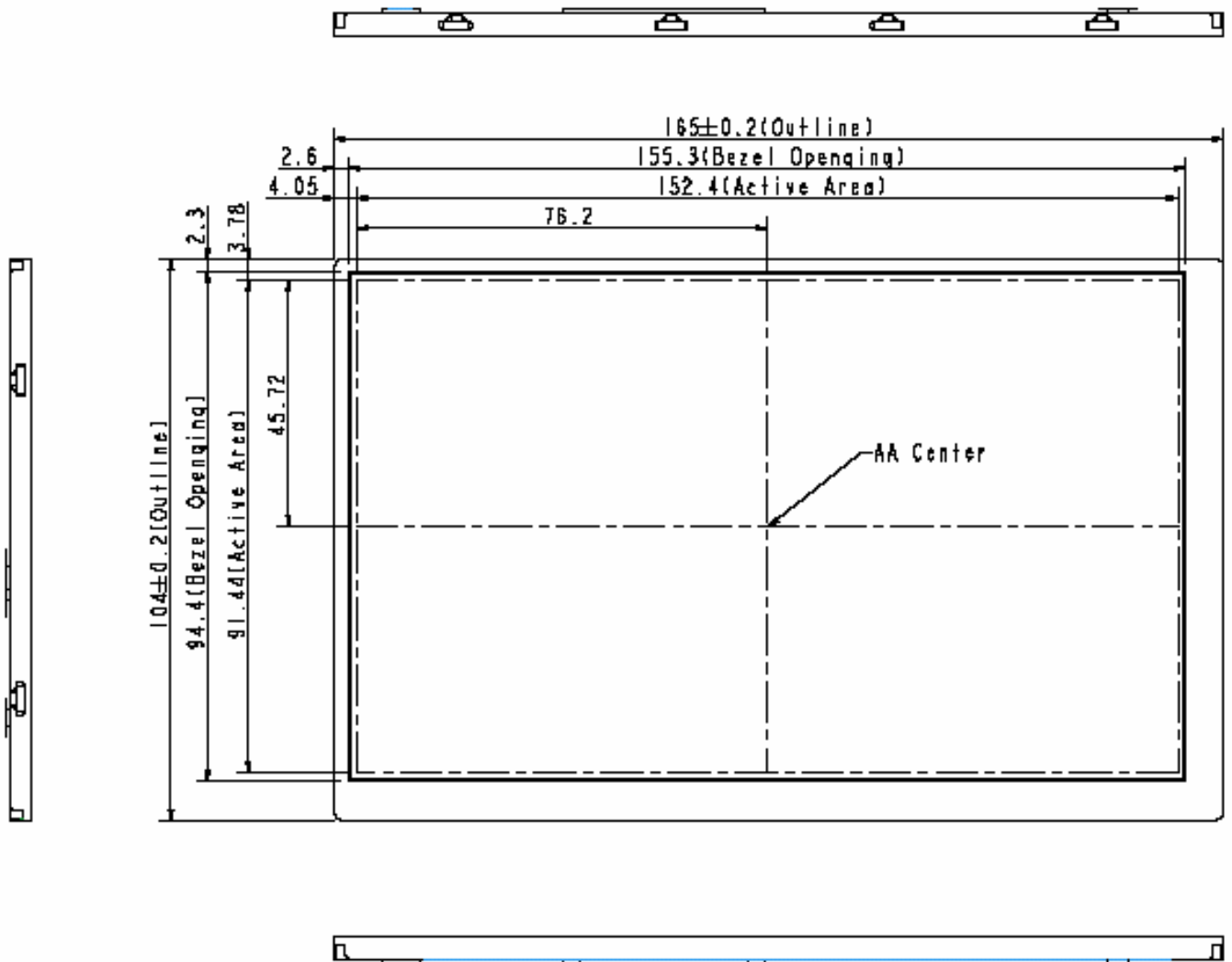

7.2 Rear Side

[Unit : mm]

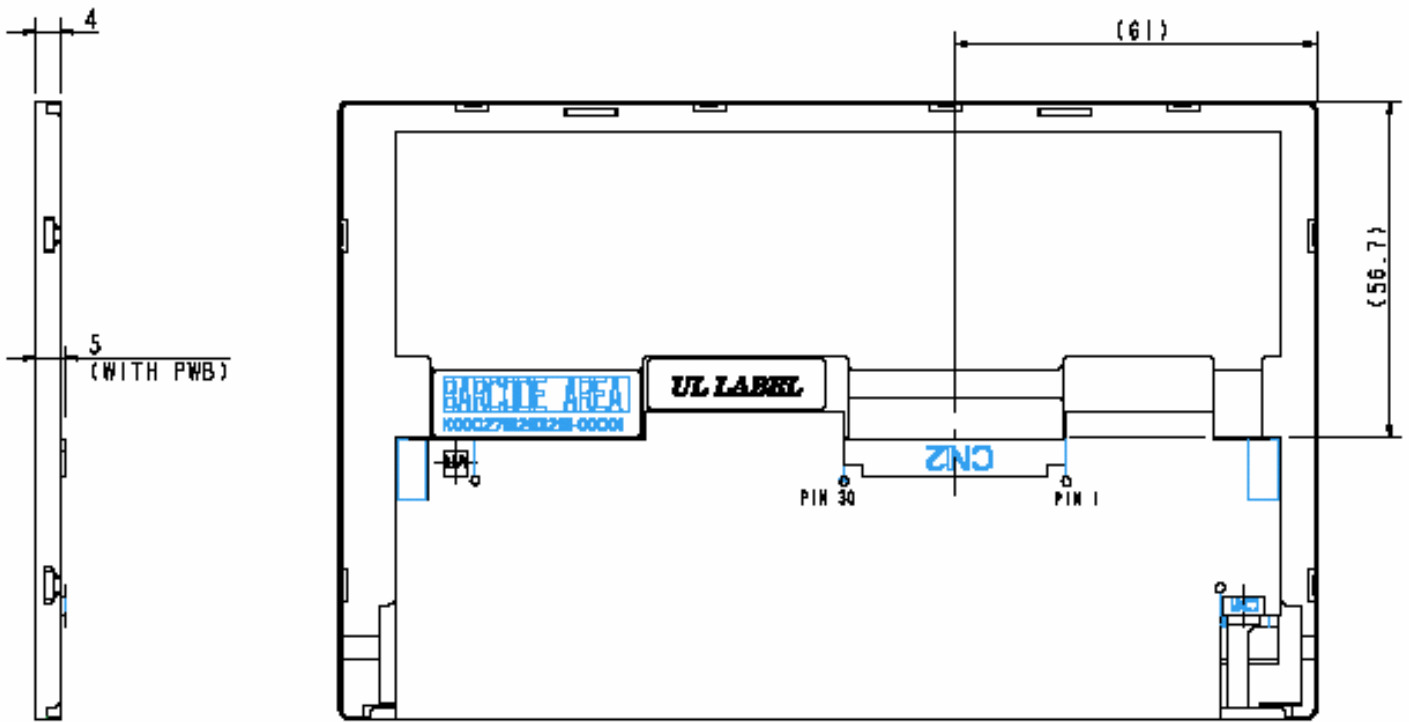

Remark : Un-indication tolerance is $\pm 0.3\text{mm}$

8. OPTICAL CHARACTERISTICS

ITEM	SYMBOL	CONDITION	MIN.	TYP.	MAX.	UNIT	Remarks
Constrast Ratio	CR	Point-5	300	400	--	--	*1)*2)*3)
Luminance*)	Lw	Point-5	176	220	--	cd/m ²	*1)*3)
Luminance Uniformity	ΔL		70	80	--	%	*1)*3)
Response Time (White - Black)	Tr+ Tf	Point-5	--	--	20	ms	*1)*3)*5)
Viewing Angle	Horizontal	CR \geq 10 Point-5	120	140	--	°	*1)*2)*4)
	Vertical		90	110	--	°	*1)*2)*4)
Color Coordinate	White	Wx Wy	0.273 0.289	0.313 0.329	0.353 0.369	--	*1)*3)
	Red	Rx Ry	(0.535 0.292)	(0.575 0.332)	(0.615 0.372)		
	Green	Gx Gy	(0.290 0.525)	(0.330 0.565)	(0.370 0.605)		
	Blue	Bx By	(0.110 0.080)	(0.150 0.120)	(0.190 0.160)		

Remarks :

*1)Measure condition : 25°C \pm 2°C , 60 \pm 10%RH , under10 Lux in the dark room.BM-5A (TOPCON) , viewing angle2° , VCC=3.3V , VDD=5V.

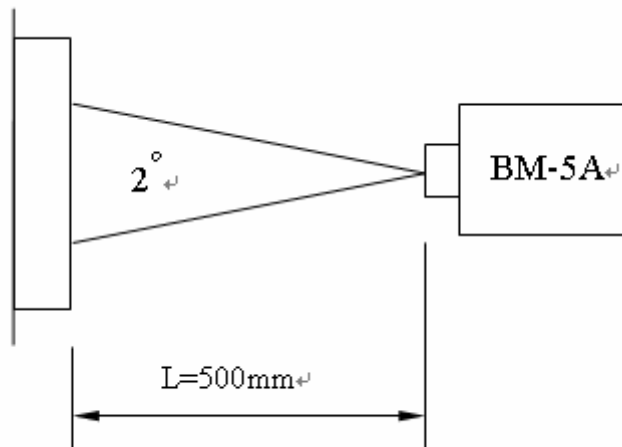

*2) Definition of contrast ratio :

Contrast Ratio (CR)= (White) Luminance of ON \div (Black) Luminance of OFF

*3) Definition of luminance :

Measure white luminance on the point 5 as figure8-1

Definition of Luminance Uniformity:

Measure white luminance on the point1~9 as figure8-1

$$\Delta L = [L(\text{MIN})/L(\text{MAX})] \times 100\%$$

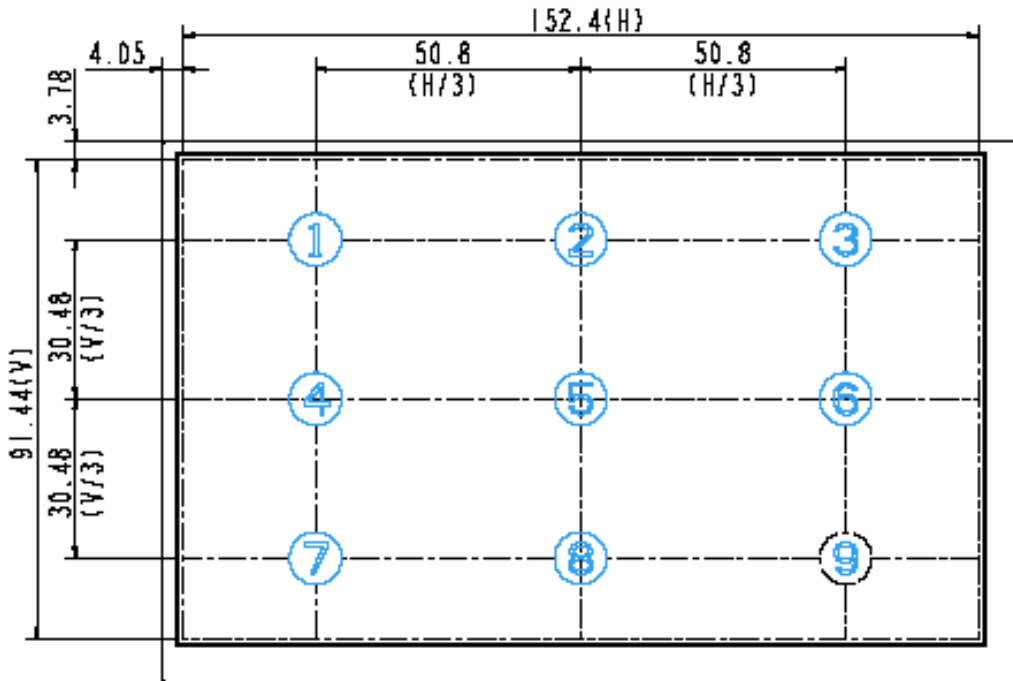

Fig8-1 Measuring point

*4) Definition of Viewing Angle(θ, ψ), refer to Fig8-2 as below :

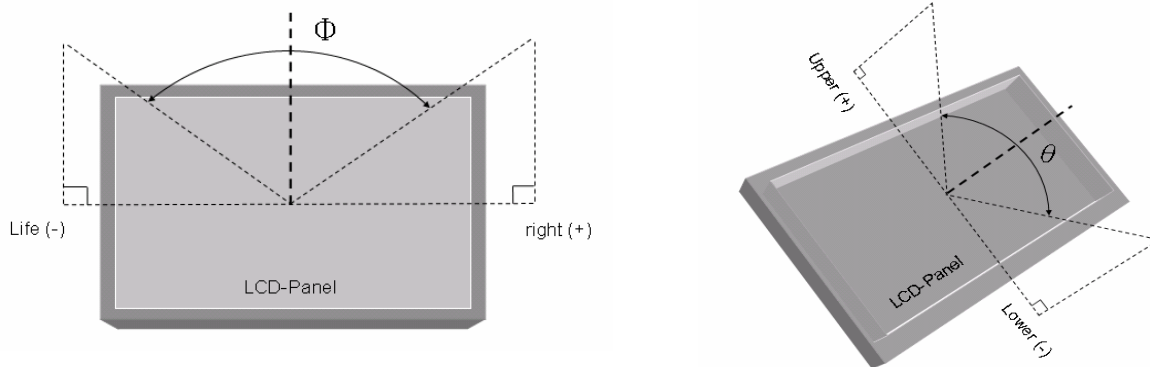

Fig8-2 Definition of Viewing Angle

*5) Definition of Response Time.(White-Black)

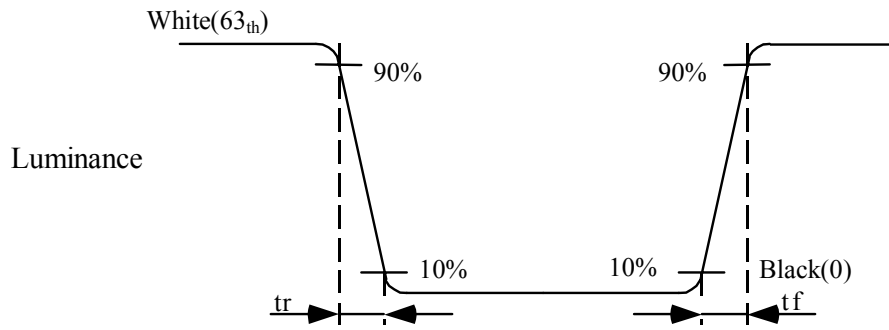

Fig9-3 Definition of Response Time(White-Black)

9. RELIABILITY TEST

9.1. Temperature and humidity

TEST ITEMS	CONDITIONS	REMARK
High Temperature Operation	85°C , 240Hrs	
High Temperature Storage	95°C , 240Hrs	
High Temperature High Humidity Operation	60°C , 90%RH , 240Hrs	No condensation
Low Temperature Operation	-30°C , 240Hrs	
Low Temperature Storage	-40°C , 240Hrs	
Thermal Shock	-30°C (0.5Hr) ~ 85°C(0.5Hr) 200 cycles	

9.2. Shock and Vibration

TEST ITEMS	CONDITIONS
Shock (Non-operation)	<ul style="list-style-type: none"> ● Shock level:980m/s²(equal to 100G) ● Waveform:half sinusoidal wave,6ms. ● Number of shocks:one shock input in each direction of three mutually perpendicular axes for a total of three shock inputs.
Vibration (Non-operation)	<ul style="list-style-type: none"> ● Frequency range:8~33.3Hz ● Stroke:1.3mm ● Vibration:sinusoidal wave,perpendicularaxis(both x, z axis:2Hrs, y axis 4Hrs). ● Sweep:2.9G,33.3Hz-400Hz ● Cycle:15min

9.3. ESD Test

ITEM	CONDITION	REMARK
ESD	150pF , 330Ω , ±8KV&±15KV air & contact test	*1)
	200pF , 0Ω , ±250V contact test	*2)

Remarks :

*1) LCD glass and metal bezel

*2) IF connector pins

9.4 Judgment standard

The Judgment of the above test should be made as follow:

Pass:Normal display image with no obvious non-uniformity and no line defect.Partial transformation of the module parts should be ignored.

Fail:No display image,obvious non-uniformity,or line defect.